

# ALGEBRA

## VA MATEMATIK ANALIZ ASOSLARI

### II

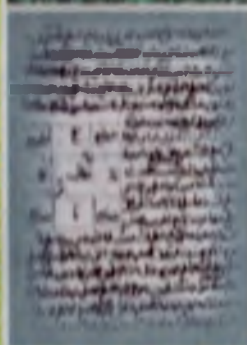

O'ZBEKISTON RESPUBLIKASI OLIY VA  
O'RTA MAXSUS TA'LIM VAZIRLIGI

O'RTA MAXSUS, KASB-HUNAR TA'LIMI MARKAZI

*A.U.Abduhamidov, H.A.Nasimov,  
U.M.Nosirov, J.H.Husanov*

# ALGEBRA VA MATEMATIK ANALIZ ASOSLARI

**II qism**

*Akademik litseylar uchun darslik*

7- nashri

„O'QITUVCHI“ NASHRIYOT-MATBAA IJODIY UYI  
TOSHKENT—2008

ББК 22.14я722  
22.161я722

**Taqrizchilar:** Samarqand Davlat me'morchilik va qurilish instituti qoshidagi litsey-internatning matematika o'qituvchisi, fizika-matematika fanlari doktori, professor **A. Savurboyev**,

Nizomiy nomidagi Toshkent Davlat pedagogika universiteti qoshidagi akademik litseyning matematika o'qituvchisi, texnika fanlari nomzodi, dotsent **R. Yarqulov**.

O'zbekiston Respublikasi Oliy va o'rta maxsus ta'lim vazirligi O'rta maxsus, kasb-hunar ta'limi markazi tomonidan akademik litseylar uchun darslik sifatida tavsiya etilgan va undan kasb-hunar kollejlari o'quvchilari ham foydalanishlari mumkin.

O'zbekiston Respublikasida xizmat ko'rsatgan  
Xalq ta'limi xodimi **H. A. NASIMOV**ning  
umumiy tahriri ostida

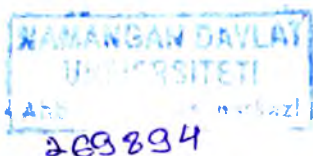

A 4306020503 — 58 Qat. buyurt. — 2008.

353(04) — 2008

ISBN 978-9943-02-072-6

© «O'qituvchi» nashriyoti, T., 2002.

© «O'qituvchi» NMIU, T., 2008.

---

---

## SO'ZBOSHI

Ushbu «Algebra va matematik analiz asoslari (II qism)» darsligi shu nomli kitob I qismining uzviy davomi bo'lib, akademik litseylar va kasb-hunar kollejlari uchun mo'ljallangan hamda shu fan bo'yicha akademik litseylar va kasb-hunar kollejlari o'quv rejasiga asosan aniq fanlar yo'nalishi, tabiiy fanlar yo'nalishi, shuningdek, matematika umumta'lim fani sifatida o'rganiladigan guruhlarining algebra va matematik analiz asoslari kursining o'quv dasturidagi barcha materiallarni o'z ichiga oladi.

Mualliflarning SamDU qoshidagi akademik litseyda to'plagan ish tajribalari asosida yaratilgan va o'n bobdan iborat bo'lgan ushbu darslikda quyidagi mavzular yoritilgan:

- Trigonometrik funksiyalar.
- Nostandart tenglamalar, tengsizliklar va sistemalar.
- Sonli ketma-ketliklar va ularning limiti.
- Funksiyaning limiti va uzluksizligi.
- Hosila.
- Integral.
- Differensial tenglamalar.
- Kombinatorika elementlari.
- Ehtimollik nazariyasi va matematik statistika elementlari.
- Chiziqli algebra elementlari.

Har bir bob paragraflarga, paragraflar esa bandlarga bo'lingan.

Darslikning yaratilish jarayonida o'zlarining qimmatli maslahatlarini ayamagan SamDU qoshidagi akademik litseyning oliy toifali matematika o'qituvchilari B. I. Usmonov va Z. A. Pashayevga, shuningdek, kitob qo'lyozmasini kompyuterda sahifalagan I. Nasimov va A. Siddiqovga o'z minnatdorchiligimizni bildiramiz.

Ayniqsa, kitobni diqqat bilan o'qib chiqib, uning sifatini yaxshilash bo'yicha qimmatli maslahatlar bergan Samarqand viloyati Ishtixon tumanidagi 21- o'rta maktabning oliy toifali matematika o'qituvchisi, O'zbekiston Respublikasida xizmat ko'rsatgan Xalq ta'limi xodimi A. A. Nasimovga samimiy tashakkur izhor etishni o'z burchimiz deb bilamiz.

*Mualliflar*



# I B O B

## TRIGONOMETRIK FUNKSIYALAR

### 1-§. Sonli argumentning trigonometrik funksiyalari

**1. Burchaklar va yoylar.** Markazi  $O$  nuqtada bo'lgan  $R$  radiusli aylanadagi  $A$  va  $B$  nuqtalar uni ikki qismga – *yoylarga* ajratadi (I.1-rasm). Yoyning  $A$  va  $B$  nuqtalari *yoyning uchlari*, qolgan nuqtalari esa *yoyning ichki nuqtalari* deyiladi.

Uchlari  $A$  va  $B$  nuqtalar bo'lgan yoy uning faqat uchlari ko'rsatish orqali  $\cup AB$  ko'rinishda yoki uchlari  $A$  va  $B$  nuqtalar bo'lgan yoylarni bir-biridan farqlash uchun yoyning uchlari va yoyning biror ichki  $K$  nuqtasini ko'rsatish orqali  $\cup AKB$  ko'rinishda belgilanadi (I.2-rasm).

Agar  $AB$  kesma aylananing diametri bo'lsa,  $AB$  yoy *yarim aylana* deyiladi. Agar  $AB$  kesma aylananing diametri bo'lmasa va  $AB$  yoyning har qanday ichki nuqtasini aylananing markazi bilan tutashtiruvchi kesma  $AB$  kesmani kesib o'tsa (kesib o'tmasa),  $AB$  yoy *yarim aylanadan kichik* (mos ravishda *yarim aylanadan katta*) deyiladi.

Aylananing markazidan chiquvchi va berilgan yoyni kesib o'tuvchi barcha nurlardan tashkil topgan yassi burchakni *berilgan yoyga mos markaziy burchak*, berilgan yoyni esa shu *markaziy burchakka mos yoy* deb ataymiz (I.3-rasm).

Yoy uzunligi metr (m) va uning ulushlarida, shuningdek, fut, duym, angstrom, mikronlarda ham o'lchanadi (1 fut = 12 duym  $\approx 30,479$  sm, 1 angstrom =  $1 \cdot 10^{-8}$  sm, 1 mikron =  $1 \cdot 10^{-3}$  mm).

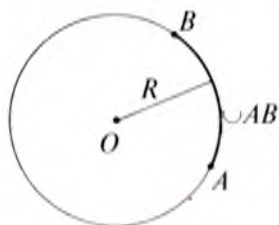

I.1-rasm.

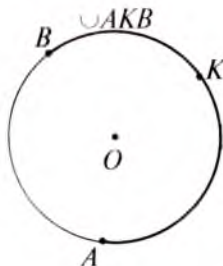

I.2-rasm.

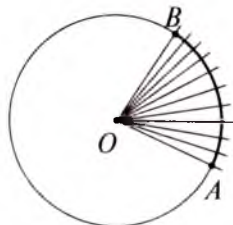

I.3-rasm.

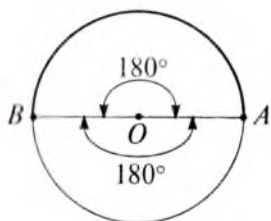

I.4-rasm.

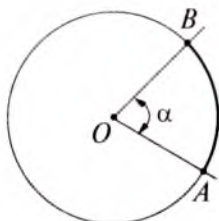

I.5-rasm.

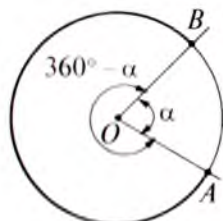

I.6-rasm.

Geometriya kursidan ma'lumki, markaziy burchakning gradus o'lchovi va yoyning gradus o'lchovi quyidagicha aniqlanadi:

1) yarim aylanaga mos markaziy burchak  $180^\circ$  ga teng (I.4-rasm);

2) yarim aylanadan kichik  $AB$  yoyga mos markaziy burchakning gradus o'lchovi  $OA$  va  $OB$  nurlar hosil qilgan odatdagi burchakning gradus o'lchoviga teng (bu yerda  $O$  – aylana markazi, I.5-rasm);

3) yarim aylanadan katta yoyga mos markaziy burchakning gradus o'lchovi  $360^\circ - \alpha$  ga teng, bu yerda  $\alpha$  – to'ldiruvchi burchak (yarim aylanadan kichik yoyga mos markaziy burchak)ning gradus o'lchovi (I.6-rasm).

4) yoyning gradus o'lchovi shu yoyga mos markaziy burchakning gradus o'lchoviga teng (I.7-rasm).

Burchak va yoylarning burchak kattaligini o'lchashda gradusning ulushlaridan ham foydalanishga to'g'ri keladi. Gradus va uning ayrim ulushlari orasidagi bog'lanishlarni keltiramiz:

$$1^\circ = 60' \text{ (minut, daqiqa)}, \quad 1' = 60'' \text{ (sekund, soniya)}.$$

Buyuk o'zbek olimi Mirzo Ulug'bek o'z asarlarida sekundning  $\frac{1}{60}$  ulushi solisa(tersiy)dan ham foydalangan. Uning asarlarida

$$1 \text{ daraja} = 60 \text{ daqiqa}, \quad 1 \text{ daqiqa} = 60 \text{ soniya},$$

$$1 \text{ soniya} = 60 \text{ solisa(tersiy)}$$

ekanligi keltiriladi.

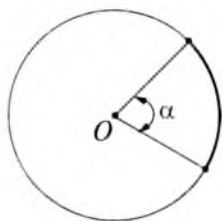

I.7-rasm.

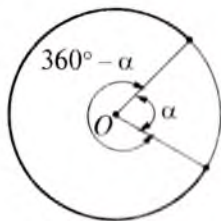

I.8-rasm.

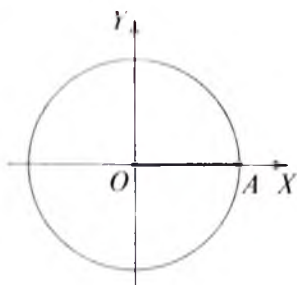

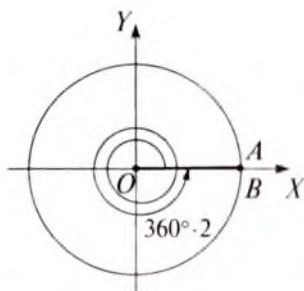

1.9-rasm.

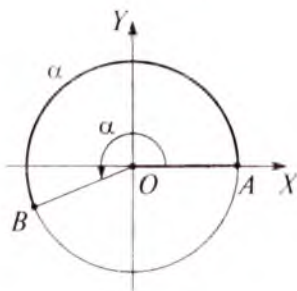

1.10-rasm.

Tekislikda to'g'ri burchakli  $XOY$  Dekart koordinatalari sistemi kiritilgan bo'lsin. Markazi koordinatalar boshida bo'lgan  $R$  radiusli aylanani qaraymiz (1.8-rasm). Bu aylana  $OX$  o'qning musbat yarim o'qini  $A$  nuqtada kessin.  $OA$  radius boshlang'ich radius,  $A$  nuqta esa boshlang'ich nuqta deb ataladi.

$OX$  o'qning musbat yarim o'qini koordinatalar boshi (qo'zg'almas nuqta) atrofida musbat yo'nalish (soat strelkasining harakat yo'nalishiga qarama-qarshi yo'nalish)da va manfiy yo'nalish (soat strelkasining harakat yo'nalishi)da istalgancha uzluksiz siljitish (harakatlantirish) mumkin deb hisoblaymiz.

$OX$  musbat yarim o'q qo'zg'almas  $O$  nuqta atrofida musbat yo'nalishda siljitsa,  $OA$  radius biror  $OB$  radiusga o'tadi. Agar  $OA$  va  $OB$  radiuslar ustma-ust tushsa (1.9-rasm), siljitish natijasida  $A$  nuqta aylanani bir yoki bir necha marta to'liq aylanib chiqqan bo'ladi. Bu holda biz boshlang'ich tomoni  $OA$  va oxirgi tomoni  $OB$  bo'lgan aylanish burchagiga ega bo'lamiz. Uning gradus o'lchovi  $360^\circ \cdot k$  ga teng, bu yerda  $k$  — aylanishlar soni.

Agar  $OA$  va  $OB$  radiuslar ustma-ust tushmasa,  $A$  nuqta aylanani to'liq aylanib chiqmagan yoki aylanani bir yoki bir necha marta aylanib chiqib, yana  $AB$  yoyini bosib o'tgan bo'ladi. Bu holda boshlang'ich tomoni  $OA$  va oxirgi tomoni  $OB$  bo'lgan burish burchagiga ega bo'lamiz. Bu burish burchagining gradus o'lchovi quyidagicha aniqlanadi:

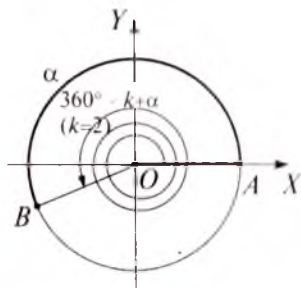

1.11-rasm.

1)  $A$  nuqta aylanani to'liq aylanib chiqmagan bo'lsa (1.10-rasm), burish burchagining gradus o'lchovi  $AB$  yoyning gradus o'lchoviga teng;

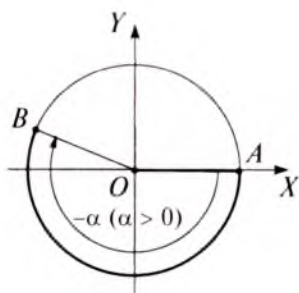

I.12-rasm.

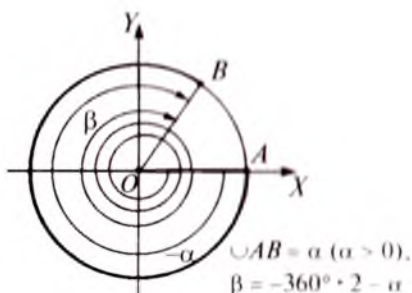

I.13-rasm.

2)  $A$  nuqta aylanani  $k$  ( $k \in \mathbb{N}$ ) marta aylanib chiqib, yana  $AB$  yoyni bosib o'tgan bo'lsa (I.11-rasm), burish burchagining gradus o'lchovi  $360^\circ \cdot k + \alpha$  ga teng, bu yerda  $\alpha$  – shu  $AB$  yoyni gradus o'lchovi.

Endi  $OX$  musbat yarim o'qni qo'zg'almas  $O$  nuqta atrofida manfiy yo'nalishda siljitamiz. Xuddi yuqoridagi kabi mulohazalar yuritib, gradus o'lchovlari  $-360^\circ \cdot k$  ( $k$  – aylanishlar soni) bo'lgan aylanish burchaklariga hamda gradus o'lchovlari  $-360^\circ \cdot k - \alpha$  (bu yerda  $k \in \{0; 1; 2; 3; \dots\}$ ) ga teng bo'lgan burish burchaklariga ega bo'lamiz (I.12- va I.13-rasmlar).

Gradus o'lchovi  $0^\circ$  ga teng burchakni ham qaraymiz. Bu burchak boshlang'ich nuqta o'z o'rnida harakatsiz turgan holatga mos keladi. Shu sababli uni burish burchagi sifatida ham, aylanish burchagi sifatida ham qarash mumkin.



## Mashqlar

**1.1.** 1) Markaziy burchak  $18^\circ$  ga teng. Gradus o'lchovi shu markaziy burchakning gradus o'lchovidan  $3\frac{1}{2}$  marta katta bo'lgan markaziy burchakka mos yoyni gradus o'lchovini toping;

2) Gradus o'lchovi  $54^\circ$  li yoyga mos markaziy burchakning gradus o'lchovidan 3 marta kichik bo'lgan markaziy burchakning gradus o'lchovini toping.

**1.2.** 1)  $3600^\circ$  li burchak aylanish burchagi bo'la oladimi?

2)  $-3600^\circ$  li burchak  $0^\circ$  li burchakka tengmi?

3)  $-542^\circ$  li burish burchagida nechta aylanish burchagi bor?

1.3. 1) Markazi koordinatalar boshida bo'lgan  $R = 3$  sm radiusli aylana chizing. Boshlang'ich radiusni  $540^\circ$  buring va hosil bo'lgan yoy uzunligini toping;

2) Markazi koordinatalar boshida bo'lgan  $R = 3$  sm radiusli aylana chizing. Boshlang'ich radiusni  $-270^\circ$  buring va hosil bo'lgan yoyning uzunligini toping.

**2. Burchak va yoylarning radian o'lchovi. Koordinatali aylana.** Burchak va yoylarning burchak kattaliklarini o'lchashning yana bir sistemasi – *radian o'lchovi sistemasi* bilan tanishamiz.

$R$  radiusli aylanani qaraylik (I.14-rasm). Uzunligi  $2\pi R$  bo'lgan bu aylanada umumiy ichki nuqtaga ega bo'lmagan va har birining uzunligi  $R$  ga teng bo'lgan  $2\pi$  ta yoy mavjud. Bu yoylardan har birining, shuningdek ularga mos har bir

markaziy burchakning burchak kattaligi  $\frac{360^\circ}{2\pi} = \frac{180^\circ}{\pi}$  ga tengdir.

Demak, uzunligi aylana radiusiga teng yoyning va unga mos markaziy burchakning burchak kattaligi aylana radiusiga bog'liq emas. Shu sababli, uzunligi aylana radiusiga teng bo'lgan yoyning burchak kattaligini shu aylana yoylarini o'lchashda o'lchov birligi sifatida, unga mos markaziy burchak kattaligini esa burchaklarni o'lchashda o'lchov birligi sifatida olish mumkin.

Uzunligi aylana radiusiga teng yoy *1 radianli yoy*, unga mos markaziy burchak esa *1 radianli burchak* deyiladi (I.15-rasm).

Yuqoridagi mulohazalardan quyidagi bog'lanishlarni olamiz:

$$1 \text{ radian} = \frac{180^\circ}{\pi}, \quad 1^\circ = \frac{\pi}{180} \text{ radian}.$$

Bu ikki tenglik yordamida radian o'lchovidan gradus o'lchoviga o'tish va gradus o'lchovidan radian o'lchoviga o'tish formulalari hosil bo'ladi:

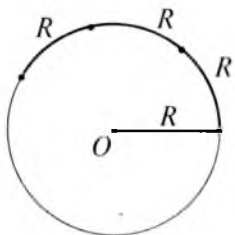

I.14-rasm.

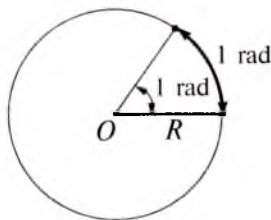

I.15-rasm.

$$a = \left(\frac{180a}{\pi}\right)^{\circ}, \quad \alpha^{\circ} = \frac{\pi \cdot \alpha}{180}.$$

1 - misol.  $120^{\circ}$  ni radianlarda,  $\frac{3\pi}{4}$  va 5 (rad)larni esa graduslarda ifodalang.

Yechish.  $\alpha^{\circ} = \frac{\pi \cdot \alpha}{180}$  (rad) formulaga ko'ra

$$120^{\circ} = \frac{\pi \cdot 120}{180} (\text{rad}) = \frac{2\pi}{3}$$

tengligni,  $a_{\text{rad}} = \left(\frac{180a}{\pi}\right)^{\circ}$  formulaga ko'ra

$$\frac{3\pi}{4} = \left(\frac{180 \cdot \frac{3\pi}{4}}{\pi}\right)^{\circ} = 135^{\circ} \quad \text{va} \quad 5 = \left(\frac{180 \cdot 5}{\pi}\right)^{\circ} = \left(\frac{900}{\pi}\right)^{\circ}$$

tenglklarni hosil qilamiz.

2 - misol. Radiusi  $R = 5$  (uzun. birl.) bo'lgan aylananing uzunligi  $l = 10$  (uzun. birl.)ga teng yoyini graduslarda va radianlarda ifodalang.

Yechish.  $l = 10$  (uzun. birl.)  $= \frac{10}{5}$  (rad)  $= 2$  (rad) va

$$l = 2 \text{ (rad)} = \left(\frac{180 \cdot 2}{\pi}\right)^{\circ} = \left(\frac{360}{\pi}\right)^{\circ} \approx 114^{\circ}19'52'' \text{ tengliklarga egamiz.}$$

3 - misol. Agar radiusi  $R = 4$  bo'lgan doiraviy sektorning yoyi 3 rad ga teng bo'lsa, shu sektorning  $S$  yuzini toping.

Yechish. Yoyi  $\pi$  rad ga teng doiraviy sektor (yarim doira)ning yuzi  $\frac{\pi \cdot R^2}{2}$  (bu yerda  $R$  — radius) ga teng bo'lgani uchun, yoyi 1 rad bo'lgan doiraviy sektorning yuzi  $\frac{R^2}{2}$  ga, yoyi  $a$  rad ga teng bo'lgan doiraviy sektorning yuzi esa  $a \cdot \frac{R^2}{2}$  ga teng. Shu sababli  $S = 3 \cdot \frac{4^2}{2} = 24$  kv. birlik.

Eslatma. 5 ning graduslarda ifodalangan aniq qiymati  $\left(\frac{900}{\pi}\right)^{\circ}$  ga teng. Uning graduslarda ifodalangan taqribiy qiymatini hosil qilish uchun  $\pi$  ni uning kerakli aniqlikdagi taqribiy qiymati bilan almashtirish kerak bo'ladi. Masalan,  $\pi \approx 3$  deb olinsa,  $5 = \left(\frac{900}{\pi}\right)^{\circ} \approx \left(\frac{900}{3}\right)^{\circ} = 300^{\circ}$  ga ega bo'lamiz. Xuddi shu kabi,  $1^{\circ} = \frac{\pi}{180}$  rad  $\approx 0.017$  (rad),  $1$  (rad)  $= \left(\frac{180}{\pi}\right)^{\circ} \approx 57^{\circ}17'44''$  munosabatlar hosil qilinadi.



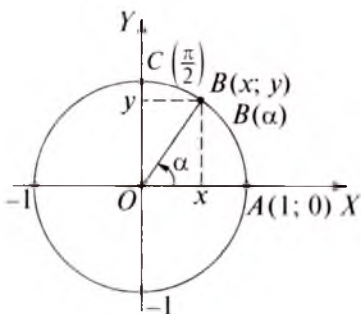

I.16-rasm.

Tekislikda  $XOY$  Dekart koordinatalari sistemasi kiritilgan bo'lsin. Markazi koordinatalar boshi  $O(0;0)$  da bo'lgan  $R=1$  radiusli aylananing  $A(1;0)$  nuqtasini *boshlang'ich nuqta*,  $OA$  radiusini esa *boshlang'ich radius* deb ataymiz (I.16-rasm) va shu aylanada koordinatalar sistemasini quyidagi tartibda kiritamiz.

Boshlang'ich nuqta  $A(1;0)$  ni yangi koordinatalar sistemasining koordinatalar boshi (sanoq boshi) sifatida olamiz. Uning yangi koordinatalar sistemasidagi koordinatasi 0 ga teng. Boshlang'ich radiusni  $O(0;0)$  nuqta atrofida  $\alpha$  radianli burchakka buramiz (bu yerda va bundan keyin aylanish burchagi burish burchagining xususiy holi sifatida qaraladi). Natijada  $A$  nuqta aylananing biror  $B(x;y)$  nuqtasiga o'tadi (I.16-rasm).  $B(x;y)$  nuqtaning yangi koordinatasi (aylanadagi koordinatasi)  $\alpha$  ga teng deb qabul qilamiz va  $B(\alpha)$  ko'rinishda belgilaymiz.

Masalan,  $C(0;1)$  nuqta boshlang'ich radiusni  $O(0;0)$  nuqta atrofida  $\frac{\pi}{2}$  rad burchakka burishdan hosil qilinadi. Shu sababli, uning yangi koordinatalar sistemasidagi koordinatasi  $\frac{\pi}{2}$  ga tengdir (I.16-rasm).

Aylananing har bir nuqtasi aylanadagi koordinatalar sistemasida cheksiz ko'p koordinatalarga ega, chunki boshlang'ich radiusni  $O(0;0)$  nuqta atrofida  $\alpha, \alpha \pm 2\pi, \alpha \pm 4\pi, \dots$ , ya'ni  $\alpha \pm 2k\pi, k \in \mathbb{Z}$  burchaklarga burish natijasida boshlang'ich nuqta aylananing ayni bir  $B$  nuqtasiga o'tadi va  $\alpha \pm 2k\pi, k \in \mathbb{Z}$  sonlarning har biri  $B$  nuqtaning koordinatasi (aylanadagi koordinatasi!) bo'ladi.

Yuqoridagi usul bilan koordinatalar sistemasi kiritilgan birlik aylana *koordinatali aylana* (yoki *koordinatalar aylanasini*) deb ataladi.

4 - misol. Koordinatali aylanada  $M\left(5\frac{1}{4}\pi\right), N\left(-5\frac{1}{4}\pi\right)$  nuqtalarni belgilang.

Yechish. 1)  $5\frac{1}{4}\pi = 2 \cdot 2\pi + \left(\pi + \frac{\pi}{4}\right)$  bo'lgani uchun  $M\left(5\frac{1}{4}\pi\right)$  va  $M_1\left(\pi + \frac{\pi}{4}\right)$  nuqtalar koordinatali aylanada ustma-

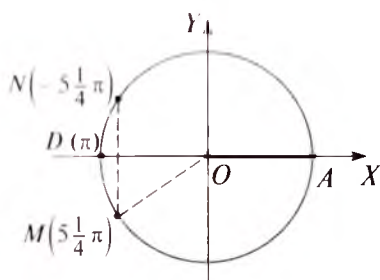

I.17-rasm.

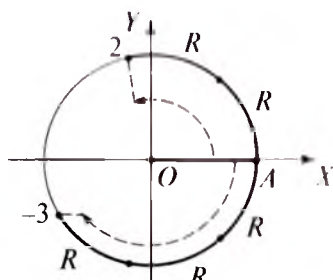

I.18-rasm.

ust tushadi.  $D(\pi)$  nuqtani (I.17-rasm) musbat yo'nalish bo'yicha  $\frac{\pi}{4} = 45^\circ$  burchakka burib,  $M\left(5\frac{1}{4}\pi\right)$  nuqtani hosil qilamiz;

2)  $N$  va  $M$  nuqtalar  $AD$  diametrga nisbatan simmetrik nuqtalar bo'lgani uchun  $M$  nuqtani shu diametrga nisbatan simmetrik almashtirib,  $N\left(-5\frac{1}{4}\pi\right)$  nuqtani hosil qilamiz (I.17-rasm).

5 - misol. Koordinatali aylanada 2 va  $-3$  sonlarini belgilang.

Yechish. 2 sonining koordinatali aylanadagi tasviri (koordinatasi 2 ga teng bo'lgan nuqta)ni topish uchun uzunligi 1 radian (aylana radiusi)ga teng bo'lgan yoyni boshlang'ich  $A$  nuqtadan boshlab, musbat yo'nalishda ketma-ket ikki marta qo'yamiz (I.18-rasm).

$-3$  sonining koordinatali aylanadagi tasvirini topish uchun uzunligi 1 radianga teng bo'lgan yoyni boshlang'ich  $A$  nuqtadan boshlab, manfiy yo'nalishda ketma-ket uch marta qo'yish yetarli (I.18-rasm).



## Mashqlar

**1.4.** Aylana radiusi  $R = 10$  sm, yoyi  $l$  (sm), yoki  $a$  (rad), yoki  $\alpha^\circ$  birliklarning birida berilgan. Yoy qolgan ikki birlikda ifodalansin:

1)  $l = 1; 2; 5; 10; 20; 30;$

2)  $\alpha = 2^\circ; 10^\circ; 10^\circ 30'; 60^\circ; 90^\circ; 180^\circ; 350^\circ; -30^\circ; -45^\circ;$

3)  $\alpha = 360^\circ; 540^\circ; 700^\circ; 720^\circ 30'; 750,5^\circ; 1000,5^\circ; -450^\circ; -660^\circ;$

4)  $\alpha = 2; 5; 10; 20\pi; 50,5\pi; -5; -\pi; -5\pi$  (rad).

**1.5.** Quyidagi nuqtalar birlik aylanada belgilansin hamda ularga aylana markaziga, gorizontaal va vertikal diametrlarga nisbatan simmetrik joylashgan nuqtalar topilsin:

$A (\pi/8)$ ,  $B (2\pi/3)$ ,  $C (5\pi/8)$ ,  $D (36^\circ)$ ,  $E (220^\circ)$ ,  $F (-75^\circ)$ ,  $G (4)$ ,  $H (-5)$ .

**1.6.** Muntazam sakkizburchakning ikki qo'shni tomoni orasidagi burchagini graduslar va radianlarda ifodalang.

**1.7.** Aylana radiusi  $R = 6$  dm. Yo'ylar  $\alpha^\circ$  kattalikda berilgan. Ularni radianlarda ifodalang va mos sektorlarning yuzini toping:

$\alpha = 12^\circ; 15^\circ; 22^\circ 30'; 24^\circ; 30^\circ; 45^\circ; 60^\circ; 72^\circ; 90^\circ; 120^\circ; 180^\circ; 225^\circ; 270^\circ; 315^\circ; 330^\circ$ .

**1.8.** Jism  $\omega = \frac{\pi}{6}$  rad/s burchak tezlik bilan aylanmoqda. U  $t = 10$  s da qanday burchakka buriladi? 2 min da-chi?

**3. Sonli argumentning sinusi, kosinusi, tangensi va kotangensi.** Tekislikda  $XOY$  Dekart koordinatalar sistemasi kiritilgan va  $t$  haqiqiy son berilgan bo'lsin.  $t$  haqiqiy songa koordinatali aylananing koordinatasi  $t$  ga teng bo'lgan  $B(t)$  nuqtasini mos qo'yamiz (1.19-rasm).

$B(t)$  nuqtaning absissasi  $t$  sonning kosinusi, ordinatasi esa  $t$  sonning sinusi deyiladi va mos ravishda  $\cos t$ ,  $\sin t$  orqali belgilanadi.

$B(t)$  nuqta ordinatasining shu nuqta absissasiga nisbati (agar bu nisbat mavjud bo'lsa)  $t$  sonning tangensi deyiladi va  $\tan t$  orqali belgilanadi.

$B(t)$  nuqta absissasining shu nuqta ordinatasiga nisbati (agar bu nisbat mavjud bo'lsa)  $t$  sonning kotangensi deyiladi va  $\cot t$  orqali belgilanadi.

Sonning sinusi, kosinusi, tangensi va kotangensi tushunchalarining aniqlanishidan ko'rinadiki,

$$\tan t = \frac{\sin t}{\cos t} \quad (\cos t \neq 0), \quad (1)$$

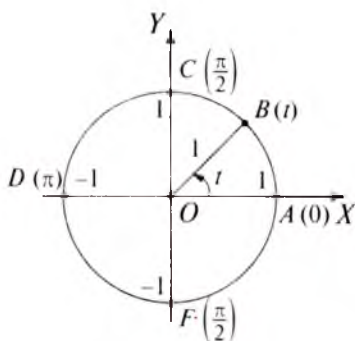

1.19-rasm.

$$\operatorname{ctg} t = \frac{\cos t}{\sin t} \quad (\sin t \neq 0) \quad (2)$$

munosabatlar o'rinli va koordinatali aylananing  $B(t)$  nuqtasi  $XOY$  koordinatalar sistemasidagi  $B(\cos t; \sin t)$  nuqta bilan ustma-ust tushadi.  $B(\cos t; \sin t)$  nuqta birlik aylana yotgani sababli, uning koordinatalari shu birlik aylana tenglamasi  $x^2 + y^2 = 1$  ni qanoatlantiradi:

$$\cos^2 t + \sin^2 t = 1. \quad (3)$$

Sonning sinusi va kosinusi tushunchalarining aniqlanishidan ko'rinadiki, ixtiyoriy  $t$  haqiqiy son uchun  $B(\cos t; \sin t)$  nuqta birlik aylana yotadi. Shu sababli, (3) tenglik  $t$  ning har qanday haqiqiy qiymatida o'rinli.

1 - misol.  $0, \frac{\pi}{2}, \pi, \frac{3\pi}{2}$  sonlarining sinusi, kosinusi, tangensi va kotangensini toping.

Yechish.  $0, \frac{\pi}{2}, \pi, \frac{3\pi}{2}$  sonlariga koordinatali aylananing  $A(0), C\left(\frac{\pi}{2}\right), D(\pi), F\left(\frac{3\pi}{2}\right)$  nuqtalari mos keladi (1.19-rasm). Bu nuqtalar  $XOY$  koordinatalar sistemasida mos ravishda quyidagi koordinatalarga ega:  $A(1; 0), C(0; 1), D(-1; 0), F(0; -1)$ .

Sonning sinusi, kosinusi, tangensi va kotangensi tushunchalarining aniqlanishiga ko'ra, quyidagi tengliklarga ega bo'lamiz:

$$\cos 0 = 1; \quad \cos \frac{\pi}{2} = 0; \quad \cos \pi = -1; \quad \cos \frac{3\pi}{2} = 0;$$

$$\sin 0 = 0; \quad \sin \frac{\pi}{2} = 1; \quad \sin \pi = 0; \quad \sin \frac{3\pi}{2} = -1;$$

$$\operatorname{tg} 0 = 0; \quad \operatorname{tg} \frac{\pi}{2} \text{ — mavjud emas}; \quad \operatorname{tg} \pi = 0; \quad \operatorname{tg} \frac{3\pi}{2} \text{ — mavjud emas};$$

$$\operatorname{ctg} 0 \text{ — mavjud emas}; \quad \operatorname{ctg} \frac{\pi}{2} = 0; \quad \operatorname{ctg} \pi \text{ — mavjud emas}; \quad \operatorname{ctg} \frac{3\pi}{2} = 0.$$

2 - misol.  $\sin \frac{\pi}{4}, \cos \frac{\pi}{4}, \operatorname{tg} \frac{\pi}{4}, \operatorname{ctg} \frac{\pi}{4}$  larni hisoblang.

Yechish. Koordinatali aylana  $B\left(\frac{\pi}{4}\right)$  nuqtani yasaymiz (1.20-rasm) va bu nuqtaning  $XOY$  koordinatalar tekisligidagi koordinatalarini aniqlaymiz.

$OBC$  teng yonli to'g'ri burchakli uchburchakda  $OB^2 = OC^2 + BC^2 = 2BC^2$  bo'lgani uchun  $2BC^2 = 1$  yoki  $BC = \frac{\sqrt{2}}{2}$  ga ega bo'lamiz.  $B\left(\frac{\pi}{4}\right)$  nuqtaning absissasi ham, ordinatasi ham musbatdir. Demak,  $B\left(\frac{\pi}{4}\right)$  nuqta  $B\left(\frac{\sqrt{2}}{2}; \frac{\sqrt{2}}{2}\right)$  nuqta bilan ustma-ust tushadi.  $\sin\alpha$ ,  $\cos\alpha$ ,  $\operatorname{tg}\alpha$ ,  $\operatorname{ctg}\alpha$  larning aniqlanishiga ko'ra,

$$\sin\frac{\pi}{4} = \frac{\sqrt{2}}{2}, \quad \cos\frac{\pi}{4} = \frac{\sqrt{2}}{2}, \quad \operatorname{tg}\frac{\pi}{4} = \frac{\frac{\sqrt{2}}{2}}{\frac{\sqrt{2}}{2}} = 1, \quad \operatorname{ctg}\frac{\pi}{4} = 1$$

tengliklarga ega bo'lamiz.

3-misol.  $\frac{\pi}{6}$  va  $-\frac{\pi}{6}$  ning sinusi, kosinusi, tangensi va kotangensini toping.

Yechish.  $B\left(\frac{\pi}{6}\right)$  nuqtani yasaymiz (I.21-rasm) va bu nuqtaning dekart koordinatalarini topamiz.  $B\left(\frac{\pi}{6}\right)$  nuqtaning dekart koordinatalari musbat sonlardir.  $OBC$  to'g'ri burchakli uchburchakda  $BC = \frac{1}{2}OB = \frac{1}{2} \cdot 1 = \frac{1}{2}$  bo'lgani uchun Pifagor teoremasiga ko'ra  $OC = \sqrt{1^2 - \left(\frac{1}{2}\right)^2} = \frac{\sqrt{3}}{2}$  bo'ladi. Demak,  $B\left(\frac{\pi}{6}\right)$  nuqta  $B\left(\frac{\sqrt{3}}{2}; \frac{1}{2}\right)$  nuqta bilan ustma-ust tushadi. Son argumentning sinusi, kosinusi, tangensi va kotangensining aniqlanishiga ko'ra

$$\sin\frac{\pi}{6} = \frac{1}{2}, \quad \cos\frac{\pi}{6} = \frac{\sqrt{3}}{2}, \quad \operatorname{tg}\frac{\pi}{6} = \frac{\frac{1}{2}}{\frac{\sqrt{3}}{2}} = \frac{1}{\sqrt{3}}, \quad \operatorname{ctg}\frac{\pi}{6} = \sqrt{3}.$$

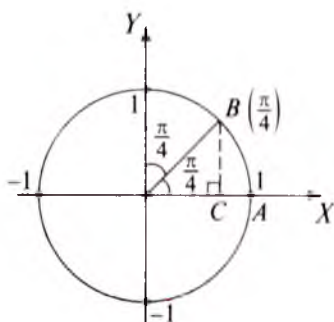

I.20-rasm.

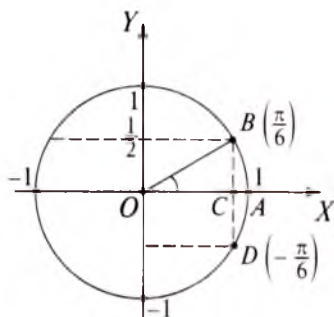

I.21-rasm.

$D\left(-\frac{\pi}{6}\right)$  va  $B\left(\frac{\pi}{6}\right)$  nuqtalar  $OX$  o'qqa nisbatan simmetrik bo'lgani uchun  $D\left(-\frac{\pi}{6}\right)$  nuqta  $D\left(\frac{\sqrt{3}}{2}; -\frac{1}{2}\right)$  nuqta bilan ustma-ust tushadi. Shu sababli

$$\sin\left(-\frac{\pi}{6}\right) = -\frac{1}{2}, \quad \cos\left(-\frac{\pi}{6}\right) = \frac{\sqrt{3}}{2},$$

$$\operatorname{tg}\left(-\frac{\pi}{6}\right) = \frac{-\frac{1}{2}}{\frac{\sqrt{3}}{2}} = -\frac{1}{\sqrt{3}}, \quad \operatorname{ctg}\left(-\frac{\pi}{6}\right) = -\sqrt{3}.$$

$y = \sin t$ ,  $y = \cos t$ ,  $y = \operatorname{tg} t$  va  $y = \operatorname{ctg} t$  formulalar bilan aniqlangan funksiyalar *asosiy trigonometrik funksiyalar* deyiladi. Ularning ayrim asosiy xossalarini keltiramiz.

1°.  $y = \sin t$  *funksiya chegaralangan funksiya va barcha  $t \in R$  lar uchun  $|\sin t| \leq 1$  munosabat o'rinli.*

**I s b o t .** Biror  $t \in R$  uchun  $|\sin t| > 1$  bo'lsin. U holda  $|\sin^2 t| = |\sin t|^2 > 1$  bo'lgani uchun  $\sin^2 t + \cos^2 t = |\sin t|^2 + |\cos t|^2 \geq |\sin t|^2 + 0 = |\sin t|^2 > 1$ , ya'ni  $\sin^2 t + \cos^2 t > 1$  tengsizlikka ega bo'lamiz. Bu esa (3) ga ziddir.

Demak, barcha  $t \in R$  sonlar uchun  $|\sin t| \leq 1$  munosabat o'rinli va  $\sin t$  funksiya chegaralangan funksiyadir.

2°.  $y = \cos t$  *funksiya chegaralangan va barcha  $t \in R$  lar uchun  $|\cos t| \leq 1$  munosabat o'rinli.*

$\alpha$	0	$\frac{\pi}{6}$	$\frac{\pi}{4}$	$\frac{\pi}{3}$	$\frac{\pi}{2}$	$\pi$	$\frac{3\pi}{2}$	$2\pi$
$\sin \alpha$	0	$\frac{1}{2}$	$\frac{\sqrt{2}}{2}$	$\frac{\sqrt{3}}{2}$	1	0	-1	0
$\cos \alpha$	1	$\frac{\sqrt{3}}{2}$	$\frac{\sqrt{2}}{2}$	$\frac{1}{2}$	0	-1	0	-1
$\operatorname{tg} \alpha$	0	$\frac{1}{\sqrt{3}}$	1	$\sqrt{3}$	Mavjud emas	0	Mavjud emas	0
$\operatorname{ctg} \alpha$	Mavjud emas	$\sqrt{3}$	1	$\frac{1}{\sqrt{3}}$	0	Mavjud emas	0	Mavjud emas



Isbot.  $\forall t \in \mathbb{R}$  da  $0 \leq \sin^2 t \leq 1$  bo'lgani uchun  $\cos^2 t = 1 - \sin^2 t \leq 1$  bo'ladi. Oxirgi tengsizlikdan,  $\forall t \in \mathbb{R}$  da  $|\cos t| \leq 1$  ekanini ko'rinadi. Demak,  $\cos t$  funksiya chegaralangan funksiya va  $\forall t \in \mathbb{R}$  da  $|\cos t| \leq 1$ .

1°, 2°- xossalardan,  $y = \sin x$  va  $y = \cos x$  funksiyalardan har birining qiymatlar sohasi  $[-1; 1]$  kesmadan iborat ekanligi kelib chiqadi.

Trigonometrik funksiyalarning ayrim burchaklardagi qiymatlari jadvalini keltiramiz:



## Mashqlar

**1.9.** Ushbu sonli qiymatlarga kosinus teng bo'la oladimi? Sinuschi?

- 1) 0,562;    2) -0,562;    3) 1,002;    4) -1,002;  
 5)  $\frac{a}{\sqrt{a^2 - b^2}}$ ;    6)  $\frac{a}{\sqrt{a^2 + b^2}}$ ,  $a > 0$ ,  $b > 1$ ;    7)  $\frac{\sqrt[3]{3}}{\sqrt{3}}$ ;    8)  $\pi$ ;  
 9)  $\frac{3\frac{1}{2}}{\pi}$ ;    10)  $\frac{\sqrt{3} - \sqrt{3}}{\sqrt{3} - 1}$ ;    11)  $\sqrt{8} - \sqrt{2}$ ;    12)  $\frac{1}{2}\left(a + \frac{1}{a}\right)$ ,  $a > 1$ .

**1.10.** 1) Agar  $\alpha = 0^\circ$ ;  $90^\circ$ ;  $\pi$ ;  $\frac{\pi}{4}$ ;  $1,5\pi$  bo'lsa,  $\sin \alpha + \cos \alpha$  va  $2(1 - \cos \alpha)$  ni toping;

2)  $y = \sin^2 \alpha + 2\cos^2 \alpha$  ifoda qabul qiladigan eng katta qiymatni toping.

**1.11.**  $R$  radiusli halqa  $OX$  o'qining musbat yo'nalishi bo'yicha yumalab bormoqda (I.22-rasm). O'qning 1 birlik kesma uzunligi  $R$  ga teng. Harakat boshida aylananing  $M$  nuqtasi  $O$  nuqtada turgan bo'lsin.

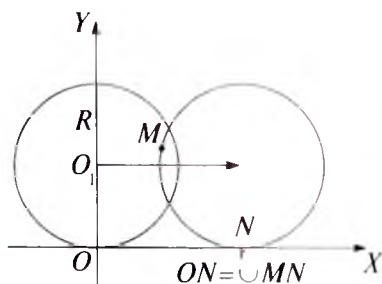

I.22-rasm.

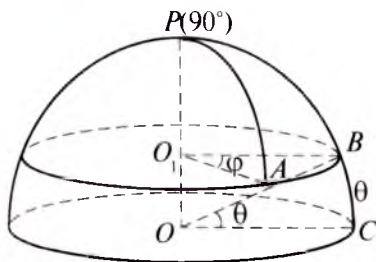

I.23-rasm.

1) Agar  $M$  nuqta  $\alpha$  rad ga burilsa, aylananing  $O_1$  markazi qanchaga siljiydi?

2)  $O_1$  markaz ( $x = 3$ ;  $y = 1$ ) nuqtaga kelishi uchun  $M$  nuqta qancha burilishi kerak?

3)  $O_1$  nuqta 5 birlik/s tezlik bilan siljimoqda.  $M$  nuqtaning burchak tezligini toping.

4)  $O_1$  nuqta sekundiga  $R$  masofaga siljisa,  $M$  nuqtaning  $t$  momentdagi o'rnining koordinatalarini toping.

**1.12.** Geografik kengligi  $\theta$  ga teng bo'lgan parallelda geografik uzunliklarining farqi  $\varphi$  ga teng bo'lgan ikki  $A$  va  $B$  nuqta olingan (1.23-rasm). Yer shari radiusi  $R$  ga teng.  $\sphericalangle AB = l$  ni toping.

**1.13.**  $A$  nuqtaga  $120^\circ$  burchak ostida qo'yilgan 10 N va 12 N kattalikdagi ikki kuchning teng ta'sir etuvchisini toping.

**1.14.** Daryo qirg'og'idagi tepalikdan shu qirg'oq gorizontali yo'nalishga nisbatan  $30^\circ$ , narigi qirg'oq  $15^\circ$  burchak ostida ko'rinadi. Daryoning kengligi 100 m. Tepalikning balandligi va uning uchidan daryo qirg'og'igacha bo'lgan masofani toping.

**1.15.** Yer radiusi  $R$  ga teng. Shimoliy yarim sharda geografik uzunligi  $\lambda$  ga, kengligi  $\varphi$  ga teng bo'lgan  $B$  nuqta olingan. Toping:

1)  $B$  nuqtadan ekvator tekisligigacha bo'lgan masofa;

2)  $B$  nuqtaning ekvator tekisligidagi proyeksiyasining koordinatalari (abssissalar o'qi ekvator bilan nolinch meridian kesishuvidagi nuqta ustidan o'tadi). Hisoblashlarni  $R = 6367$  km,  $\lambda = 30^\circ$  va  $\varphi = 60^\circ$  uchun ham bajaring.

**1.16.**  $\triangle BOA$  da  $OA = OB = R$ ,  $MA = R(1 - \cos t)$ ,  $BM = R \sin t$ ,  $OM = R \cos t$  (1.24-rasm). Isbot qiling:

$$\sin t = \pm \sqrt{(1 - \cos t)(1 + \cos t)}; \quad AB = R\sqrt{2(1 - \cos t)}.$$

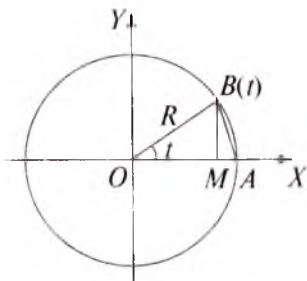

1.24-rasm.

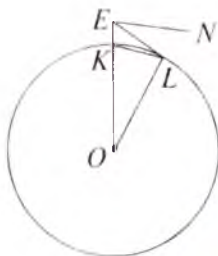

1.25-rasm.

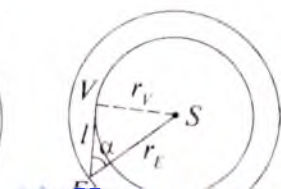

**NAMANGAN DAVLAT**  
**UNIVERSITETI**  
1.26-rasm.  
Axborot-resurs markazi

2698910

**1.17.** Teng yonli  $AOB$  uchburchak yuzi 64,  $MA = 8$  (1.24-rasm).  
 $AB = ?$

**1.18.** Yer sathidan  $EK = h$  (1.25-rasm) balandlikda joylashgan  $E$  kuzatuv punktidan gorizont chizig'idagi  $L$  nuqta gorizonttal yo'nalishga nisbatan  $\angle NEL = \alpha$  burchak ostida ko'rinadi (Abu Rayhon Beruniyning «Qonuni Ma'sudiy» asaridan). Agar  $h \approx 3$  km va  $R \approx 6367$  km bo'lsa,  $\alpha$  ni toping.

**1.19.** 1.26-rasmda  $V$  Venera va  $E$  Yer orbitalari aylana ko'rinishida tasvirlangan, Yerning  $S$  Quyoshdan uzoqligi  $r_E = 149500000$  km.

Oddiy kuzatishda Venera Quyoshga nisbatan  $\alpha \approx 46^\circ$  burchak ostida chetlashgan ko'rinadi. Bu chetlanish ko'pi bilan qancha bo'lishi mumkin?

1) Veneraning Quyoshdan  $r_V$  uzoqligini hisoblang.

2) Venera sutkalik harakati davomida Quyoshdan  $\alpha$  qadar ortda qolishi mumkin.  $U$  holda  $u$  kechasi ko'rinadi. Aksincha,  $\alpha$  qadar oldin o'tgan bo'lsa, ertalab, Quyosh chiqmasdan oldin ko'rinadi. Nima uchun, tushuntiring.

**1.20.** 1.24-rasmda tasvirlangan koordinatali aylanada  $\cup AB = t$ .

1)  $t$ ,  $360^\circ + t$ ,  $360^\circ - t$ ,  $-360^\circ + t$ ,  $2\pi k + t$ ,  $k \in \mathbb{Z}$  yoylarga mos nuqtalar ustma-ust tushadimi? Agar ular ustma-ust tushsa, bu nuqtalarga mos trigonometrik funksiyalar o'rtasida qanday bog'lanishlar mavjud bo'ladi? Misollar keltiring. Shu ishni  $\pi k + t$ ,  $k \in \mathbb{Z}$  va  $\frac{\pi}{2} + t$ ,  $k \in \mathbb{Z}$  nuqtalar uchun takrorlang;

2) yuqoridagi ishni  $B(t)$  nuqtaga  $O$  markazga nisbatan simmetrik bo'lgan  $E(\pi + t)$  nuqtaga nisbatan ham bajaring.

**4. Trigonometrik funksiyalarning davriyligi.** Trigonometrik funksiyalarning davriyligi haqidagi teoremlarni keltiramiz.

**1-teorema.**  $\cos t$  va  $\sin t$  funksiyalarning har biri davriy funksiya va ularning asosiy davri  $2\pi$  ga teng.

**Isbot.** Ixtiyoriy  $t \in \mathbb{R}$  son uchun  $K(t)$ ,  $L(t + 2\pi)$ ,  $M(t - 2\pi)$  nuqtalar koordinatali aylanada ustma-ust tushadi. Shu sababli ularning Dekart koordinatalari bir xil:

$$x = \cos t = \cos(t - 2\pi) = \cos(t + 2\pi),$$

$$y = \sin t = \sin(t - 2\pi) = \sin(t + 2\pi). \quad (1)$$

Demak,  $\cos t$  va  $\sin t$  funksiyalar davriy funksiyalar va  $2\pi$  soni ulardan har birining biror davridir.  $2\pi$  soni ulardan har biri uchun asosiy davr bo'lishligini ko'rsatamiz.

$0 < T_1 < 2\pi$  soni  $\cos t$  ning davri deb faraz qilaylik. U holda, masalan,  $t = 0$  da  $\cos 0 = \cos(0 + T_1) = 1$ , ya'ni  $\cos T_1 = 1$  bo'lishi kerak.

Koordinatali aylana da absissasi 1 ga teng bo'lgan faqat bitta  $(1; 0)$  nuqta mavjud va unga  $t = 2\pi k$ ,  $k \in \mathbb{Z}$  sonlari mos keladi.  $T_1$  son esa bu sonlar orasida mavjud emas. Demak, farazimiz noto'g'ri, kosinus funksiyaning asosiy davri  $2\pi$  sonidan iborat. Shu kabi, masalan,  $t = \frac{\pi}{2}$  da  $\sin \frac{\pi}{2} = \sin(\frac{\pi}{2} + T_1) = 1$  tenglikni qanoatlantiradigan va  $2\pi$  dan kichik bo'lgan  $T_1$  musbat son yo'q. Demak,  $T = 2\pi$  soni sinus funksiyaning asosiy davri.

**2 - teorema.** *tgt davriy funksiya va uning asosiy davri  $\pi$  ga teng.*

**Isbot.**  $t \neq \frac{\pi}{2} + \pi k$ ,  $k \in \mathbb{Z}$  bo'lsin.  $K(t)$ ,  $L(t + \pi)$ ,  $M(t - \pi)$  nuqtalarni qaraymiz.  $L(t + \pi)$ ,  $M(t - \pi)$  nuqtalar ayni bir xil Dekart koordinatalariga ega, ya'ni ular ustma-ust tushadi. Shu nuqtalarning umumiy absissasi  $x$ , umumiy ordinatasi esa  $y$  bo'lsin (I.27-rasm). U holda,  $\operatorname{tg}(t + \pi) = \operatorname{tg}(t - \pi) = \frac{y}{x}$  bo'ladi.  $K(t)$  va  $L(t + \pi)$  nuqtalar diametral qarama-qarshi nuqtalar bo'lgani uchun  $K(t)$  nuqtaning absissasi  $-x$  ga, ordinatasi esa  $-y$  ga tengdir (I.27-rasm). Shu sababli,

$$\operatorname{tg} t = \frac{-y}{-x} = \frac{y}{x} = \operatorname{tg}(t + \pi) = \operatorname{tg}(t - \pi).$$

Demak,  $\operatorname{tg} t$  funksiya davriy funksiya va  $t = \pi$  soni uning biror davridir. Bu son  $\operatorname{tg} t$  ning asosiy davri ekanini ko'rsatamiz.  $T$  son  $\operatorname{tg} t$  ning asosiy davri, ya'ni barcha  $t \neq \frac{\pi}{2} + \pi k$ ,  $k \in \mathbb{Z}$  sonlari uchun  $\operatorname{tg}(t + T) = \operatorname{tg} t$  tenglik o'rinli bo'lsin. Oxirgi tenglik  $t = 0$  da ham bajariladi:  $\operatorname{tg} T = 0$ . Bu yerdan  $T = \pi k$ ,  $k \in \mathbb{Z}$  ekanini ko'ramiz. Shunday qilib,  $\operatorname{tg} t$  ning asosiy davri  $\pi k$ ,  $k \in \mathbb{Z}$  sonlari orasidagi eng kichik musbat son, ya'ni  $\pi$  sonidir. Demak,  $T = \pi$ .

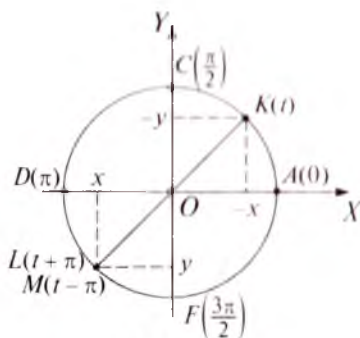

I.27-rasm.

3-teorema. ctg  $t$  davriy funksiya va uning asosiy davri  $\pi$  ga teng (mustaqil isbotlang).



## Mashqlar

**1.21.**  $y = 1 - \cos t$  funksiyaning davriyligini isbot qiling va asosiy davrini toping.

**1.22.** 1)  $f(x) = \sin x$ ,  $g(x) = \frac{1}{x}$ ,  $x \neq 0$  bo'lsa,  $g \circ f$  kompozitsiya davriy funksiya bo'la oladimi?  $f \circ g$  -chi? Agar shunday bo'lsa, davrini toping.

2) Agar  $\frac{5}{3}$  va  $\frac{2}{7}$  sonlari  $f$  funksiyaning davrlari bo'lsa,  $\frac{17}{21}$  soni ham uning davri bo'lishini isbot qiling.

3)  $y = \cos(\alpha x)$  ning asosiy davrini toping.

4)  $y = \sqrt{\cos x}$  ning aniqlanish sohasini toping va davriylikka tekshiring.

5) Quyidagi funksiyalarning davriy emasligini isbot qiling:

$$y = \cos x^2; \quad y = \sin \sqrt{|x|}; \quad y = \sin x^3;$$

$$y = \sin x + \cos(x\sqrt{3}).$$

**1.23.** Funksiyalarning davrini toping:

1)  $y = \sin 5x + \cos 4x$ ;

2)  $y = \cos x + 2\sin 4,9x$ ;

3)  $y = \sqrt{\sin 4,3x - \sin 10x + 3}$ .

**5. Sinus va kosinus funksiyalarning xossalari.** Sinus va kosinus funksiyalarning xossalari bilan tanishishni davom ettiramiz.

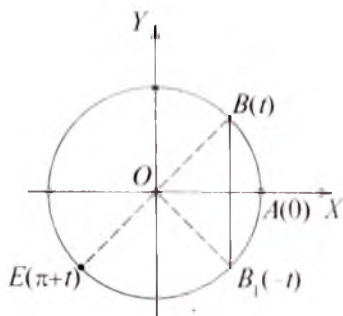

1.28-rasm.

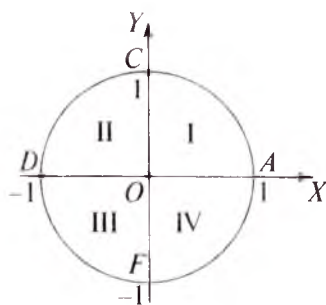

1.29-rasm.

1)  $\sin t$  funksiya argumentning  $t = \pi k$ ,  $k \in Z$  qiymatlaridagina,  $\cos t$  funksiya esa argumentning  $t = \frac{\pi}{2} + \pi k$ ,  $k \in Z$  qiymatlaridagina nolga aylanadi. Haqiqatan, koordinatali aylanada faqat ikki  $A(0) = A(1; 0)$  va  $D(\pi) = D(-1; 0)$  nuqtaning ordinatasi nolga teng, ya'ni  $y = \sin t = 0$  (I.27-rasm). Bu nuqtalarga  $2\pi k$ ,  $k \in Z$  va  $\pi + 2\pi k$ ,  $k \in Z$  sonlar to'plamlari mos. Bu ikkala to'plamni bitta  $\{\pi k, k \in Z\}$  to'plamga birlashtirib yozamiz. Shu kabi koordinatali aylanada faqat ikki  $C\left(\frac{\pi}{2}\right) = C(0; 1)$  va  $F\left(\frac{3\pi}{2}\right) = F(0; -1)$  nuqta absissasi nolga teng (I.27-rasm), ya'ni  $x = \cos t = 0$ . Bu nuqtalarga  $\frac{\pi}{2} + 2\pi k$ ,  $\frac{3\pi}{2} + 2\pi k = \frac{\pi}{2} + (2k + 1)\pi$ ,  $k \in Z$  sonlar to'plamlari yoki  $\left\{\frac{\pi}{2} + \pi, k \in Z\right\}$  to'plam mos;

2)  $\cos t$  – juft funksiya,  $\sin t$  – toq funksiya. Haqiqatan,  $B(t)$  va  $B_1(-t)$  nuqtalar absissalar o'qiga nisbatan simmetrik joylashganligidan (I.28-rasm) ularning absissalari teng, ordinalari esa faqat ishoralari bilan farq qiladi. Demak,  $\cos(-t) = \cos t$ , ya'ni  $\cos t$  juft funksiya,  $\sin(-t) = -\sin t$ , ya'ni  $\sin t$  toq funksiya;

3) agar  $B(t)$  nuqta koordinatali aylana bo'ylab  $\pi$  qadar siljitsa,  $\cos t$  va  $\sin t$  funksiyalar o'z ishoralarini o'zgartiradi:

$$\cos(t + \pi) = -\cos t; \quad (1)$$

$$\sin(t + \pi) = -\sin t. \quad (2)$$

Haqiqatan,  $B(t)$  va  $E(\pi + t)$  nuqtalar koordinatalar boshiga nisbatan simmetrik joylashganligidan (I.28-rasm) ularning koordinatalari qarama-qarshi ishorali bo'ladi:

4)  $A(1; 0)$ ,  $C(0; 1)$ ,  $D(-1; 0)$ ,  $F(0; -1)$  nuqtalar koordinatali aylanani to'rt chorakka ajratadi (I.29-rasm). Agar  $A(0)$  nuqta  $A$  dan  $C$  gacha siljitsa,  $A$  nuqta absissasi 1 dan 0 gacha kamayadi, ordinatasi esa 0 dan 1 gacha o'sadi. Demak,  $0 \leq t \leq \frac{\pi}{2}$  oraliqda (I chorakda)  $\sin t$  funksiya nomanfiy va 0 dan 1 gacha o'sadi,  $\cos t$  ham nomanfiy, lekin 1 dan 0 gacha kamayadi. Qolgan choraklarda ham shu kabi ma'lumotlarni to'plab, quyidagi jadvalni tuzamiz:



Funksiya	$0 < t < \frac{\pi}{2}$	$\frac{\pi}{2} < t < \pi$	$\pi < t < \frac{3\pi}{2}$	$\frac{3\pi}{2} < t < 2\pi$
$\sin t$	musbat, 0 dan 1 gacha o'sadi	musbat, 1 dan 0 gacha kamayadi	musbat, 0 dan -1 gacha kamayadi	musbat, -1 dan 0 gacha o'sadi
$\cos t$	musbat, 0 dan 1 gacha o'sadi	musbat, 1 dan 0 gacha kamayadi	musbat, 0 dan -1 gacha kamayadi	musbat, -1 dan 0 gacha o'sadi



## Mashqlar

**1.24.**  $1 - \cos t$  funksiya (Mirzo Ulug'bek bu funksiyani sahmi  $t$  funksiya deb atagan) ishoralarining saqlanish oraliqlarini, nollarini, juft-toqligini aniqlang,  $180^\circ \pm \alpha$  yoy sahmining  $1 + \cos \alpha$  ga tengligini tekshiring,  $\alpha$  yoy sahmi  $1 - \cos \alpha$  ga teng.

**1.25.**  $\sin t$ ,  $\cos t$  va  $1 - \cos t$  mos ravishda:

1)  $\frac{2\sqrt{10}}{7}$ ;  $\frac{3}{7}$ ;  $\frac{4}{7}$  ga teng bo'lishi mumkinmi?

2)  $-\frac{a}{\sqrt{a^2+b^2}}$ ;  $\frac{b}{\sqrt{a^2+b^2}}$ ;  $1 - \frac{b}{\sqrt{a^2+b^2}}$  ga-chi ?

**1.26.** Quyida  $t$  ning qiymatlari ko'rsatilgan.  $B(t)$  nuqta qaysi chorakda joylashgan,  $\sin t$ ,  $\cos t$  lar qanday ishoraga ega bo'ladi?

- 1)  $\frac{5}{4}\pi$ ; 2)  $\frac{4}{5}\pi$ ; 3)  $\frac{\pi}{7}$ ; 4)  $\frac{2\pi}{3}$ ; 5) 3; 6) 3,13;  
 7)  $1,7\pi$ ; 8)  $1,78\pi$ ; 9)  $-1,78\pi$ ; 10)  $-2,8$ ; 11)  $-4$ ;  
 12)  $-1,31$ ; 13) 49600; 14)  $356^\circ$ ; 15)  $247^\circ 36' 42''$ ;  
 16)  $34680^\circ$ ; 17)  $-674^\circ$ ; 18)  $-107^\circ 13' 55''$ .

**1.27.** Ayniyatlarni isbot qiling:

1)  $\frac{\sin x}{\cos x} + \frac{\cos x}{\sin x} = \frac{1}{\cos x \sin x}$ , bunda  $\sin x \neq 0$ ,  $\cos x \neq 0$ ;

2)  $\frac{\sin 30^\circ}{\cos 30^\circ} + \frac{\cos 30^\circ}{\sin 30^\circ} = \frac{4}{\sqrt{3}}$ ; 3)  $\sin^2 x \cdot \cos^2 x + \cos^2 x + \sin^4 x = 1$ ;

4)  $\sin^2 x - \cos^2 x = \sin^4 x - \cos^4 x$ ;

5)  $\sin^2 x - \sin^2 x \cos^2 x - \cos^4 x = 1 - 2\cos^2 x$ ;

6)  $\cos^2 x + \sin^2 x \cdot \cos^4 x - \sin^6 x = 1 - 2\sin^4 x$ ;

7)  $6(\sin^4 x + \cos^4 x) - 4(\cos^6 x + \sin^6 x) = 2$ .

**1.28.**  $\sin x - \cos x = m$  bo'lsa,  $\sin x$  va  $\cos x$  ni hisoblamay, quyidagilarni toping:

1)  $\sin^3 x - \cos^3 x$ ;                      2)  $\sin^4 x - \cos^4 x$ .

**1.29.** Tenglamalarni yeching:

1)  $\sin 10x = 0$ ; 2)  $\cos 5x = 0$ ; 3)  $\sin \frac{x}{3} = 0$ ; 4)  $\cos \frac{x}{5} = 0$ ;

5)  $\sin\left(2x - \frac{\pi}{6}\right) = 0$ ; 6)  $\sin\left(6x + \frac{\pi}{4}\right) = 0$ ; 7)  $\cos\left(\frac{x}{6} - \frac{\pi}{2}\right) = 0$ ;

8)  $\sin\left(\frac{x}{4} + \frac{\pi}{8}\right) = 0$ .

**1.30.** Ifodalarni soddalashtiring:

1)  $2\cos(\pi + x) + 3\cos(-x) + \cos(\pi - x)$ ;

2)  $\sin(\pi + x) - 2\sin(\pi - x) - 3\sin(-x)$ ;

3)  $4\cos(-x) + 5\sin(\pi + x) - 2\sin(\pi - x) - 6\cos(\pi + x)$ .

**1.31.** a) Quyidagi funksiyalarni juft-toqlikka tekshiring:

1)  $\sin^9 x$ ;    2)  $\cos^9 x$ ;    3)  $\sin^8 x$ ;    4)  $5\cos^5 x + 6\cos^4 x$ ;

5)  $3\sin^3 x - 2\sin^2 x$ ;    6)  $3\sin^3 x + 4\cos^5 x$ ;    7)  $\frac{4\sin^2 x + \cos^5 x + 2}{\sin^3 x}$ .

b) Ifodalarning ishoralarini aniqlang:

1)  $\sin \frac{6}{5} \pi \cdot \cos \frac{7}{4} \pi$ ;                      2)  $\sin \frac{3}{4} \pi \cdot \sin \frac{7}{3} \pi \cdot \cos \frac{7}{4} \pi$ ;

3)  $\sin 0,9 \cos(-1) \cos 4$ .

**1.32.** Sinus va kosinus funksiyalar qaysi choraklarda bir xil ishoraga ega?

**1.33.** Agar:

1)  $\cos t = 3\sin t$ ; 2)  $\cos t = \sin^2 t$ ; 3)  $\sin t = 2\cos^3 t$ ; 4)  $\cos t = \sin^4 t$  bo'lsa,  $t$  qaysi chorakka tegishli bo'ladi?

**1.34.** Agar: 1)  $t$  burchak ikkinchi chorakka tegishli va  $\cos t = -\frac{2}{3}$  bo'lsa,  $\sin t$  nimaga teng bo'ladi?

2)  $t$  burchak uchinchi chorakka tegishli va  $\sin t = -\frac{4}{5}$  bo'lsa,  $\cos t$  nimaga teng bo'ladi?

**1.35.** Qaysi biri katta:

1)  $\sin 45^\circ$  yoki  $\sin \frac{\pi}{3}$ ; 2)  $\cos 45^\circ$  yoki  $\cos \frac{\pi}{3}$ ; 3)  $\sin 50^\circ$  yoki  $\cos 50^\circ$ ?

**1.36.** Ifodalarning qiymatlarini hisoblang:

1)  $\sin 240^\circ$ ;    2)  $\cos 240^\circ$ ;    3)  $\sin \frac{9\pi}{6}$ ;    4)  $\sin\left(-\frac{11\pi}{3}\right)$ ;

$$5) \cos\left(-\frac{7\pi}{3}\right); \quad 6) \cos^2\left(-\frac{13\pi}{3}\right) + \sin^2\left(-\frac{11\pi}{6}\right);$$

$$7) \cos\pi \cdot \cos 90^\circ - \frac{3\cos(-180)^\circ}{\cos 180^\circ};$$

$$8) \cos\pi \cdot \sin\frac{3\pi}{2} + \frac{\sin\frac{5\pi}{2}}{\cos 0} - \frac{1}{\cos\left(-\frac{5\pi}{4}\right)}; \quad 9) \frac{\cos^2 30^\circ}{\sin^2 30^\circ} - \frac{\sin^2 45^\circ}{\sin^2 45^\circ}.$$

**1.37.**  $f(x) = 6\sin 4x - 3\cos 4x$  funksiyaning  $f(0)$ ,  $f\left(\frac{\pi}{2}\right)$ ,  $f\left(-\frac{\pi}{4}\right)$  qiymatlarini hisoblang.

**1.38.** Ayirmalarning ishoralarini aniqlang:

$$1) \sin 38^\circ - \sin 40^\circ; \quad 2) \cos 51^\circ - \cos 21^\circ; \quad 3) \sin \frac{\pi}{9} - \sin \frac{\pi}{4};$$

$$4) \sin 48^\circ - \sin 52^\circ; \quad 5) \cos \frac{\pi}{9} - \cos \frac{\pi}{4}; \quad 6) \sin 132^\circ - \sin 152^\circ;$$

$$7) \cos \frac{\pi}{10} - \cos \frac{\pi}{20}; \quad 8) \sin \frac{\pi}{10} - \sin \frac{\pi}{20}; \quad 9) \sin 12^\circ - \cos 732^\circ.$$

**1.39.** Funktsiyalarning o'sish va kamayish oraliqlarini toping:

$$1) y = \sin \frac{x}{3}; \quad 2) y = \cos \frac{x}{3}; \quad 3) y = \sin 5x; \quad 4) y = \cos 5x;$$

$$5) y = \sin\left(x + \frac{\pi}{3}\right); \quad 6) y = \cos\left(x + \frac{\pi}{3}\right); \quad 7) y = 4 \sin\left(x - \frac{\pi}{3}\right);$$

$$8) y = \sin\left(\frac{x}{3} + 3\right); \quad 9) y = \cos^2 x; \quad 10) y = \sin^2 \frac{x}{2};$$

$$11) y = -3 \cos^4 \frac{x}{3}; \quad 12) y = \cos(5x + 60^\circ); \quad 13) y = \sin(2x - 60^\circ).$$

**1.40.** Funktsiyalarning o'sish va kamayish oraliqlarini toping:

$$1) y = 2\sin 3x - 3\cos 2x; \quad 2) y = \frac{1}{2\cos x}; \quad 3) y = \frac{1}{\cos(2x+1)};$$

$$4) y = \sqrt{|\sin x|}; \quad 5) y = \sin^4 x + 2\sin^2 x \cos^2 x + \cos^4 x;$$

$$6) y = \cos 2x + \sin^2 x; \quad 7) y = \cos x + \sin 2x;$$

$$8) y = \sqrt{3} \sin\left(\frac{1}{2}x + \frac{\pi}{4}\right).$$

**1.41.** Funktsiyalarni o'sish va kamayishga tekshiring:

$$1) y = \sin^2 x + 1; \quad 2) y = \cos 3x - \cos 5x + 6x;$$

$$3) y = (\cos 2x + 3)(1 - 4\sin x); \quad 4) y = \cos \frac{1}{2}x - \sin \frac{1}{2}x + 3x - 7.$$

**1.42.** Funksiya  $x$  ning qaysi qiymatlarida aniqlanmagan?

1)  $y = \frac{1}{\sin x}$ ;      2)  $y = \frac{1}{\cos x}$ ;      3)  $y = \frac{\cos x}{1 - \sin x}$ ;

4)  $y = 0,8\sin^2 x - 0,75$ ;      5)  $y = \frac{2\sin x + 1}{2\cos x - 1}$ .

**1.43.** Quyidagi funksiyalarning eng kichik musbat davrini toping:

1)  $y = \cos 4x$ ;

2)  $y = 10\cos 0,5x$ ;

3)  $y = 2\cos\left(3x - \frac{\pi}{6}\right)$ ;

4)  $y = 9\cos(\omega t + \varphi)$ ,  $\omega \neq 0$ ;

5)  $y = -30\sin\left(5x + \frac{\pi}{4}\right)$ ;

6)  $y = \frac{\sqrt{3}}{2}\sin\left(\frac{\pi}{6} - 2x\right)$ ;

7)  $y = \frac{5}{6}\sin\left(4\pi x + \frac{\pi}{3}\right)$ ;

8)  $y = A\sin(\omega t + \varphi)$ ,  $A \in \mathbb{R}$ ,  $\omega \neq 0$ ;

9)  $y = 10\cos 4x - 8\sin\left(5x + \frac{\pi}{4}\right)$ ;

10)  $y = -10\cos \frac{x}{2} + 4\sin \frac{x}{2}$ ;

11)  $y = 5\cos x \sin 2x$ ;

12)  $y = \frac{\sin x - 2}{\cos x + 2}$ .

**1.44.** Funksiyalarning aniqlanish sohasini toping, maksimal va minimal qiymatlarini hisoblang; agar  $x$  ning qiymati  $\pi/6$  dan  $\pi/3$  gacha ortsa, funksiya qanday o'zgaradi?

1)  $y = \sin\left(\frac{\pi}{6} - x\right)$ ;      2)  $y = \cos(45^\circ - x)$ .

## 6. Tangens va kotangens funksiyalarning xossalari.

1) *Tangens va kotangens davriy funksiyalardir va ularning asosiy davri  $T = \pi$  (4- band, 2, 3- teoremlar);*

2)  $\operatorname{tg} t$  va  $\operatorname{ctg} t$  — toq funksiyalar. Haqiqatan,  $\cos \alpha \neq 0$  da

$$\operatorname{tg}(-t) = \frac{\sin(-t)}{\cos(-t)} = \frac{-\sin t}{\cos t} = -\operatorname{tg} t \text{ ga, } \sin t \neq 0 \text{ da } \operatorname{ctg}(-t) = -\operatorname{ctg} t \text{ ga ega}$$

bo'lamiz. Tangens va kotangenslarning davri  $\pi$  ga teng va ular toq funksiyalar bo'lgani uchun  $\operatorname{tg}(\pi - t) = \operatorname{tg}(\pi + (-t)) = \operatorname{tg}(-t) = -\operatorname{tg} t$ ,  $\operatorname{ctg}(\pi + (-t)) = -\operatorname{ctg} t$ , ya'ni

$$\operatorname{tg}(\pi - t) = -\operatorname{tg} t, \quad (1)$$

$$\operatorname{ctg}(\pi - t) = -\operatorname{ctg} t. \quad (2)$$

tengliklar o'rinli bo'ladi;

3)  $\left(0; \frac{\pi}{2}\right)$  oraliqda  $\operatorname{tg} t$  funksiya 0 dan  $+\infty$  gacha o'sadi,  $\operatorname{ctg} t$  esa  $+\infty$  dan 0 gacha kamayadi.

Haqiqatan,  $\left(0; \frac{\pi}{2}\right)$  da  $\sin t$  va  $\cos t$  musbat, sinus o'suvchi, kosinus kamayuvchi, demak,  $\operatorname{tg} t$  o'suvchi, xususan,  $t = 0$  da

$\operatorname{tg} 0 = \frac{\sin t}{\cos t} = \frac{0}{1} = 0$  bo'ladi,  $t$  burchak  $\frac{\pi}{2}$  ga yaqinlashganda  $\sin t$  qiymati 1 gacha o'sadi,  $\cos t$  esa 0 gacha kamayadi. natijada  $\frac{\sin t}{\cos t} = \operatorname{tg} t$  funksiya  $+\infty$  gacha o'sadi, aksincha  $\frac{\cos t}{\sin t} = \operatorname{ctg} t$  funksiya 0 gacha kamayadi.

Olingan xulosalar hamda tangens va kotangensning toq funksiyaligidan foydalanib,  $(-\frac{\pi}{2}; 0)$  oraliqda ularning manfiy ekanligini,  $\operatorname{tg} t$  funksiyaning  $-\infty$  dan 0 gacha o'sishini hamda  $\operatorname{ctg} t$  ning 0 dan  $-\infty$  gacha kamayishini aniqlaymiz. Uchinchi va to'rtinchi choraklardagi holatlarini aniqlashda ularning xossalari  $T = \pi$  davr bilan takrorlanishidan foydalanamiz. Xususan,  $(\pi; \frac{3\pi}{2})$  dagi holat  $(0; \frac{\pi}{2})$  dagiga,  $(\frac{\pi}{2}; \pi)$  dagi holat  $(-\frac{\pi}{2}; 0)$  dagiga o'xshash.

4)  $t$  ning  $\operatorname{tg} t$ ,  $\operatorname{ctg} t$  funksiyalar aniqlangan qiymatlarida quyidagi ayniyatlar o'rinli:

$$\operatorname{tg} t \operatorname{ctg} t = 1, \quad t \neq \frac{k\pi}{2}, \quad k \in Z, \quad (3)$$

$$1 + \operatorname{tg}^2 t = \frac{1}{\cos^2 t}, \quad t \neq \frac{\pi}{2} + k\pi, \quad k \in Z, \quad (4)$$

$$1 + \operatorname{ctg}^2 t = \frac{1}{\sin^2 t}, \quad t \neq k\pi, \quad k \in Z. \quad (5)$$

(3) ayniyat  $\operatorname{tg} t = \frac{\sin t}{\cos t}$  va  $\operatorname{ctg} t = \frac{\cos t}{\sin t}$  tengliklarni ko'paytirish orqali, (4) va (5) ayniyatlar esa  $\sin^2 t + \cos^2 t = 1$  tenglikning har ikkala qismini avval  $\cos^2 t$  ga, so'ng  $\sin^2 t$  ga bo'lish orqali hosil bo'ladi.

Misol. Agar  $\operatorname{tg} t = -\frac{2}{3}$  va  $t \in (\frac{\pi}{2}; \pi)$  bo'lsa,  $\sin t$ ,  $\cos t$ ,  $\operatorname{ctg} t$  ning qiymatini topamiz.

Yechish. II chorakda  $\sin t > 0$ ,  $\cos t < 0$ , u holda  $\operatorname{ctg} t < 0$ . (3) ayniyat bo'yicha  $\operatorname{ctg} t = -\frac{3}{2}$ ; (4) ayniyat bo'yicha:

$$\cos^2 t = \frac{1}{1 + \left(-\frac{2}{3}\right)^2} = \frac{9}{13}, \quad \cos t = -\frac{3}{\sqrt{13}} = -\frac{3\sqrt{13}}{13}. \quad \text{Shu kabi (5)}$$

bo'yicha  $\sin t = \frac{2\sqrt{13}}{13}$  ni topamiz.



**1.45.** Ifodalarning qiymatini toping:

1)  $(a \operatorname{ctg} 30^\circ)^2 - (b \operatorname{ctg} 45^\circ)^2$ ;    2)  $\left(a \operatorname{ctg} \frac{\pi}{4}\right)^3 - \left(b \operatorname{ctg} \frac{\pi}{6}\right)^3$ ;

3)  $a^2 \operatorname{ctg}^2 \frac{\pi}{4} + b^2 \operatorname{ctg}^2 \frac{\pi}{6} - c^2 \operatorname{ctg}^2 \frac{\pi}{3}$ ;

4)  $a \sin \pi \operatorname{tg} 1,2\pi - b \cos 1,5\pi + \operatorname{ctg} \pi \sin 1,8\pi$ ;

5)  $a^2 \left(1 - \cos \frac{\pi}{2}\right)^2 + b^2 \cos^2(-31,1\pi) \operatorname{ctg} \frac{\pi}{2}$ ;    6)  $a^2 \operatorname{tg}^3 \frac{\pi}{3} - b^2 \operatorname{ctg}^2 \frac{\pi}{3}$ .

**1.46.** Quyidagi qiymatni asosiy trigonometrik funksiyalarning qaysi biri qabul qila oladi:

1)  $\frac{a^2+1}{2a}$ ,  $a > 0$ ;    2)  $\frac{2a^2+1}{3a}$ ,  $a > 0$ ;    3)  $\frac{a^4+2a^2+1}{4a^2}$ ,  $a > 0$ ;

4)  $\frac{(a+b)^2}{4ab}$ ,  $a > 0$ ,  $b > 0$ ,  $a \neq b$ ;    5)  $\frac{2\sqrt{ab}}{a+b}$ ,  $a > 0$ ,  $b > 0$ ,  $a \neq b$ .

**1.47.** Ayniyatlarni isbot qiling:

1)  $\frac{\cos x}{\operatorname{ctg} x} = \sin x$ ;    2)  $\cos x \operatorname{tg} x = \sin x$ ;    3)  $1 = \sin^2 x + \frac{\sin^2 x}{\operatorname{tg}^2 x}$ ;

4)  $\frac{\cos^2 x}{\operatorname{tg}^2 x} + \cos^2 x = 1$ ;    5)  $(1 - \cos^2 x)(1 + \operatorname{ctg}^2 x) = 1$ ;

6)  $\cos^2 x \operatorname{tg}^2 x + \cos^2 x = 1$ ;    7)  $(1 + \operatorname{tg}^2 x)(1 - \sin^2 x) = 1$ ;

8)  $(\operatorname{tg} x + 1)^2 + (\operatorname{tg} x - 1)^2 = \frac{2}{\cos^2 x}$ ;    9)  $\frac{1}{1 + \operatorname{ctg}^2 x} \cdot \frac{1 + \operatorname{tg}^2 x}{\operatorname{tg}^2 x} = 1$ ;

10)  $(1 - \cos \alpha + \sin \alpha)^2 = 2(1 - \cos \alpha)(1 + \sin \alpha)$ ;

11)  $\frac{1}{\sin^2 \alpha \sin^2 \beta} - \frac{\operatorname{ctg}^2 \alpha}{\sin^2 \beta} - \operatorname{ctg}^2 \beta = 1$ ;

12)  $\operatorname{ctg}^2 \alpha \operatorname{ctg}^2 \beta + \operatorname{ctg}^2 \alpha + \frac{1}{\sin^2 \beta} = \frac{1}{\sin^2 \alpha \sin^2 \beta}$ .

**1.48.**  $\sin \alpha = \frac{2ab}{a^2+b^2}$ ,  $a > 0$ ,  $b > 0$ ,  $0 \leq \alpha \leq \frac{\pi}{2}$  bo'lsa,  $\cos \alpha$  va  $\operatorname{tg} \alpha$  ni toping.

**1.49.**  $\operatorname{ctg} \alpha = -1$  ekani ma'lum.  $\frac{8 \sin \alpha - 6 \cos \alpha}{4 \cos \alpha - 3 \sin \alpha}$  kasrning qiymatini toping.



**1.50.**  $\cos\alpha = -0,5$ ,  $90^\circ \leq \alpha \leq 180^\circ$  bo'lsa,  $\sin\alpha$ ,  $\operatorname{tg}\alpha$  va  $\operatorname{ctg}\alpha$  ni toping.

**1.51.**  $\sin\alpha = -\frac{2}{3}$ ,  $\frac{3\pi}{2} < \alpha < 2\pi$  bo'lsa,  $\cos\alpha$ ,  $\operatorname{tg}\alpha$ ,  $\operatorname{ctg}\alpha$  ni toping.

**1.52.** Ifodalarni soddalashtiring:

1)  $\operatorname{ctg}^2\alpha - \cos^2\alpha + \cos^2\alpha \operatorname{ctg}^2\alpha$ ;      2)  $\cos^2\alpha + \sin^2\alpha \operatorname{tg}^2\alpha - \operatorname{tg}^2\alpha$ ;

3)  $\sin^2\alpha - \frac{1}{1+\operatorname{ctg}^2\alpha}$ ;      4)  $\cos^2\alpha - \frac{1}{1+\operatorname{tg}^2\alpha}$ .

**1.53.** Barcha trigonometrik funksiyalarni

1)  $\sin\alpha$ ;      2)  $\cos\alpha$ ;      3)  $\operatorname{tg}\alpha$ ;      4)  $\operatorname{ctg}\alpha$  orqali ifodalang.

**1.54.** Isbot qiling:

1)  $\operatorname{tg}\alpha + \operatorname{ctg}\alpha \geq 2$ , bunda  $\operatorname{tg}\alpha > 0$ ;

2)  $\frac{(\sin x - \cos x)^2 - 1}{\operatorname{tg}x - \sin x \cos x} = -2\operatorname{ctg}^2x$ ;

3)  $\frac{\sin^2 x}{\operatorname{tg}^3 x} - \frac{\cos^2 x}{\operatorname{ctg}^3 x} + \frac{1}{\sin x \cos x} = 2\operatorname{tg}x$ ;      4)  $\sin^3 x - \sin^6 x \leq \frac{1}{4}$ .

**1.55.** Agar  $\sin x + \cos x = 1,5$  bo'lsa, quyidagilarni hisoblang:

1)  $\operatorname{tg}^2x + \operatorname{ctg}^2x$ ;      2)  $\operatorname{tg}^3x + \operatorname{ctg}^3x$ ;      3)  $\operatorname{tg}^4x + \operatorname{ctg}^4x$ .

**1.56.** Agar  $\cos^6x + \sin^6x = q$  bo'lsa,  $\cos^4x + \sin^4x$  ni toping.

**1.57.**  $y = \frac{\sin x}{x}$  funksiya  $(0; \frac{\pi}{2})$  oraliqda kamayuvchi funksiya ekanligini isbot qiling.

**1.58.**  $y = \frac{\operatorname{tg}x}{x}$  funksiya  $(0; \frac{\pi}{2})$  oraliqda o'suvchi funksiya ekanligini isbot qiling.

**1.59.** Ayirmalar ishorasini aniqlang:

1)  $\operatorname{tg}164^\circ - \operatorname{tg}165^\circ$ ; 2)  $\operatorname{tg}379^\circ - \operatorname{tg}10^\circ$ ; 3)  $\operatorname{ctg}187^\circ - \operatorname{ctg}6^\circ$ ;

4)  $\operatorname{tg}(5\frac{1}{7}\pi) - \operatorname{tg}(5\frac{1}{6}\pi)$ ;      5)  $\operatorname{ctg}\frac{\pi}{6} - \operatorname{tg}\frac{\pi}{6}$ .

**1.60.**  $x \in (\pi; 2\pi)$  oraliqda quyidagi funksiyalarning monoton o'sish va monoton kamayish oraliqlarini aniqlang:

1)  $y = \operatorname{tg}x$ ; 2)  $y = \operatorname{ctg}x$ ; 3)  $y = \frac{1}{1+\operatorname{ctg}^2x}$ ; 4)  $y = \frac{1}{1+\operatorname{tg}^2x}$ ; 5)  $y = \operatorname{ctg}^4x$ .

**1.61.**  $y = \sqrt{\operatorname{tg}(\sin x)}$  funksiyaning aniqlanish sohasini toping, bu funksiya qabul qiladigan eng kichik va eng katta qiymatlarni hisoblang, agar  $x$  ning qiymati  $\frac{\pi}{6}$  dan  $\frac{\pi}{3}$  gacha ortsa,  $y$  funksiya qanday o'zgaradi?

## 2-§. Trigonometrik funksiyalarning grafiklari

**1. Sinus va kosinus funksiyalarning grafigi.**  $y = \sin x$  funksiya grafigi *sinusoida*,  $y = \cos x$  funksiyaning grafigi esa *kosinusoida* deb ataladi. Ularni yasashda trigonometrik funksiyalarning xossaligidan foydalanamiz.

$\sin x$  – davriy funksiya va uning asosiy davri  $T = 2\pi$  bo'lgani uchun,  $OX$  o'qida uzunligi  $2\pi$  ga teng bo'lgan biror oraliqni, masalan,  $[-\pi; \pi]$  oraliqni ajratamiz (I.30-rasm) va unda grafikning mos qismini yasaymiz. Agar sinusning toq funksiya ekani e'tiborga olinsa,  $[-\pi; \pi]$  oraliqning yarmi  $[0; \pi]$  bilan chegaralanish,  $\sin x = \sin(\pi - x)$  ekani, ya'ni  $x$  va  $\pi - x$  nuqtalar  $\frac{\pi}{2}$  ga nisbatan simmetrik joylashganliklari ham nazarda tutilsa,  $[0; \frac{\pi}{2}]$  oraliq bilan chegaralanish yetarli. Shu oraliqda yasalgan qismi  $x = \frac{\pi}{2}$  to'g'ri chiziqqa nisbatan simmetrik akslantirilsa, grafikning  $[\frac{\pi}{2}; \pi]$  dagi qismi hosil qilinadi, natijada grafikning  $[0; \pi]$  dagi qismi chizilgan bo'ladi. Bu qism  $(0; 0)$  koordinatalar boshiga nisbatan simmetrik akslantirilsa,  $[-\pi; \pi]$  oraliqdagi qismi hosil bo'ladi. Endi uni  $2\pi$  davr bilan son o'qi bo'yicha davom ettirish qoldi. Grafikni  $[0; \frac{\pi}{2}]$  oraliqda geometrik yasash uchun koordinatali aylananing I choragini ( $AC$  yoyni, I.30-rasm)

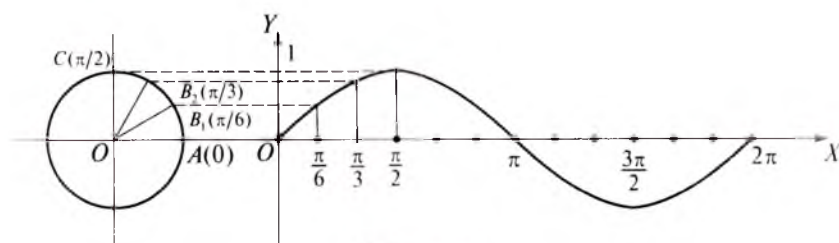

I.30-rasm.

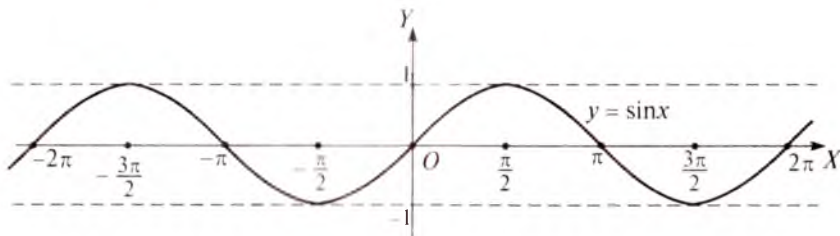

I.31-rasm.

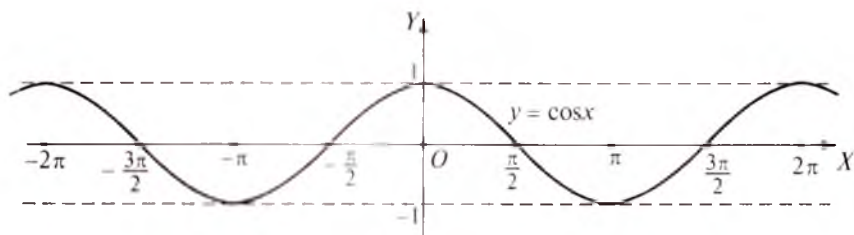

I.32-rasm.

$B_1, B_2, \dots$  nuqtalar bilan teng bo'laklarga ajratamiz.  $OX$  o'qining shu oralig'i ham shuncha teng bo'lakka ajratiladi. Agar aylanadagi bo'linish nuqtalaridan  $OX$  o'qiga parallel va  $OX$  o'qidagi bo'linish nuqtalardan  $OY$  o'qiga parallel to'g'ri chiziqlar o'tkazsak, ularning kesishish nuqtalari izlanayotgan sinusoidada yotgan bo'ladi. Nuqtalar ustidan uzluksiz chiziq chizamiz. U sinusoidaning eskizi bo'ladi.

$y = \cos x$  kosinusoidani ham yuqorida ko'rsatilgan tartibda yasash mumkin. Funksiyaning asosiy davri  $T = 2\pi$ . Demak, grafikni uzunligi  $2\pi$  ga teng biror oraliqda, masalan,  $[-\pi; \pi]$  oraliqda yasash, so'ng uni son o'qi bo'yicha  $2\pi$  davr bilan ikki tomonga davom ettirish kerak.  $\cos x$  juft funksiya bo'lganidan bu oraliqning  $[0; \pi]$  qismini,  $\cos(\pi - x) = -\cos x$  munosabatga ko'ra esa yanada kichik  $[0; \frac{\pi}{2}]$  oraliqni tanlaymiz. Unda yasalgan grafik  $Ox$  o'qidagi  $x = \frac{\pi}{2}$  nuqtaga nisbatan simmetrik almashtirilsa, grafikning  $x = \pi$  gacha qismi hosil bo'ladi. Bu qism ordinatalar o'qiga nisbatan simmetrik almashtirilsa, grafikning  $[-\pi; \pi]$  dagi qismi hosil qilinadi. Grafikning  $[0; \frac{\pi}{2}]$  dagi qismi yuqorida sinusoidani yasashda ko'rsatilgandek hosil qilinadi. Lekin bunda grafikdagi nuqta ordinatasi koordinatali aylanada unga mos nuqta absissasiga teng bo'lishi kerak.

Kosinusoidani yasashning boshqa yo'li sinusoidani  $\frac{\pi}{2}$  qadar chapga parallel ko'chirishdan iborat.

1.31, 1.32-rasmlarda mos ravishda sinusoida va kosinusoida tasvirlangan.



## Mashqlar

**1.62.**  $y = \cos x$  funksiya grafigi (1.32-rasm) bo'yicha shu funksiyaning monotonlik oraliqlarini ko'rsating.

**1.63.** Funksiyalarning grafiklarini yasang:

- 1)  $y = 3\cos x$ ;      2)  $y = -2\sin x$ ;      3)  $y = |\cos x|$ ;  
4)  $y = \cos|x|$ ;      5)  $y = \sin\left(x - \frac{\pi}{6}\right)$ ;      6)  $y = \sin\left|x - \frac{\pi}{6}\right|$ ;  
7)  $y = \{\cos x\}$ ;      8)  $y = \{\cos x\}$ ;      9)  $y = 3\sin\left\{x + \frac{\pi}{4}\right\}$ .

**1.64.** Grafiklarni chizing:

- 1)  $|y| = \cos x$ ;      2)  $|y| = \cos|x|$ ;      3)  $|y| = |\sin x|$ ;  
4)  $|y| = \left|\cos\left|x - \frac{\pi}{6}\right|\right|$ ;      5)  $y = 1 - \cos|x|$ .

**1.65.** Funksiyalarning aniqlanish sohasini, qiymatlari sohaslarini, o'sish, kamayish va ishoralarining saqlanish oraliqlarini, maksimum va minimum nuqtalarini ko'rsating, grafiklarini yasang:

- 1)  $y = \cos x + 3$ ;      2)  $y = 2\sin\left(\frac{\pi}{2} - 2x\right)$ ;  
3)  $y = 3\cos(\pi - 2x)$ ;      4)  $y = \left|\cos x + \frac{3}{2}\right|$ ;      5)  $y = -(1 - \cos x)$ .

**1.66.** 1)  $y = \sin x$  funksiyaning grafigini yasang. Sinusoidani siljitish yordamida kosinusoidani hosil qiling;

2) sinusoidani 2 birlik yuqoriga va 1 birlik chapga surish natijasida qanday funksiyaning grafigi hosil bo'ladi? Shu funksiyaning xossalarini uning grafigi bo'yicha aniqlang.

**1.67.** Quyidagi funksiyalarni juft-toqlikka, davriylikka tekshiring va grafiklarini yasang:

- 1)  $y = \sin 3x$ ;      2)  $y = \cos 3x$ ;      3)  $y = \frac{1}{3}\sin x$ ;  
4)  $y = \frac{1}{3}\cos x$ ;      5)  $y = 3\sin x$ ;      6)  $y = 3\cos x$ ;  
7)  $y = \sin x + 3$ ;      8)  $y = \cos x - 3$ ;      9)  $y = 3\sin 0,5x + 1$ ;  
10)  $y = 2\cos 3x - 1$ .

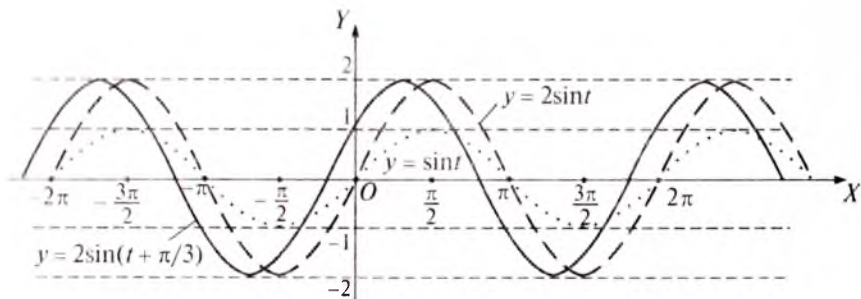

1.33-rasm.

**2. Sinusoidal tebranishlar.** Tebranma harakat trigonometrik funksiyalar orqali ifodalanadi. Matematik mayatnikning harakat tenglamasi, o'zgaruvchan elektr toki kuchi yoki kuchlanishining o'zgarish qonuniyatlari bunga misol bo'la oladi. Eng sodda tebranma harakat *sinusoidal* (yoki *garmonik*) tebranishlardir.

Biror nuqta radiusi  $A$  ga teng aylana bo'yicha  $\omega$  rad/s burchak tezlik bilan harakat qilayotgan bo'lsin. Nuqta  $t$  s da  $\omega t$  radianga teng yoy chizadi. Agar aylananing markazi koordinatalar bo'shida joylashtirilgan va  $t = 0$  vaqt momentida nuqta biror  $B_0(\alpha)$  nuqtada turgan bo'lsa,  $t$  vaqtdan so'ng u  $B(\omega t + \alpha)$  ga keladi.  $B$  nuqta koordinatalari:

$$x = A \cos(\omega t + \alpha) \quad (1)$$

va

$$y = A \sin(\omega t + \alpha). \quad (2)$$

Bunga qaraganda  $B$  nuqtaning  $t$  ga bog'liq ravishda harakati davomida uning  $x$  va  $y$  koordinatalari  $OX$  va  $OY$  o'qlari bo'yicha ko'pi bilan  $|A|$  qadar oldinga-keyinga siljiydi, tebranadi va o'tilgan masofa (1) va (2) munosabatlardagi sinus va kosinus qiymatiga bog'liq bo'ladi. Bu harakat sinusoidal tebranishdir. (1) va (2) tenglikdagi  $A$  son tebranishning qulochini ifodalaydi va tebranish *amplitudasi* deyiladi,  $\omega$  esa  $2\pi$  vaqt birligi ichidagi to'liq tebranishlar soni bo'lib, *burchak chastotasi* deyiladi.  $\alpha$  son nuqtaning aylanadagi boshlang'ich o'rni, ya'ni *boshlang'ich faza*.

(1) va (2) funksiyalarning asosiy davri  $T = \frac{2\pi}{\omega}$  (isbot qiling!).

(1) yoki (2) garmonik tebranishlar grafigini sinusoidadan foydalanib yasash maqsadida (2) funksiya ifodasini  $y = A \sin \omega \left( t + \frac{\alpha}{\omega} \right)$  ko'rinishda yozamiz. Bunga qaraganda grafikni yasash uchun  $\sin t$



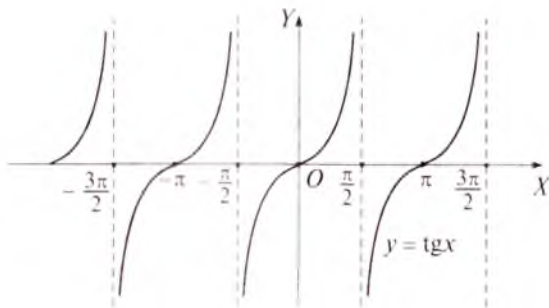

I.35-rasm.

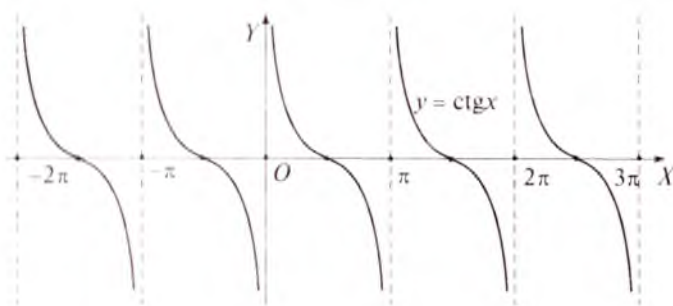

I.36-rasm.

nuqtalarda kesishsin. Chizmaga qaraganda  $AT_1 = \operatorname{tg} \frac{\pi}{6}$ ,  $AT_2 = \operatorname{tg} \frac{\pi}{3}$  va hokazo.  $T_1, T_2, \dots$  nuqtalardan  $OX$  o'qiga parallel va  $x = \frac{\pi}{6}, \frac{\pi}{3}, \dots$  nuqtalardan  $OY$  o'qiga parallel o'tkazilgan to'g'ri chiziqlarning kesishish nuqtalari belgilanadi. Ular ustidan o'tadigan egri chiziq  $\operatorname{tg} x$  funksiyaning grafigi (*tangensoida*) bo'ladi.

Grafik  $x = \frac{\pi}{2}$  to'g'ri chiziqqa tomon yaqinlashganida yuqoriga cheksiz ko'tariladi. Endi koordinatalar boshiga nisbatan markaziy simmetriya, so'ng absissalar o'qi bo'yicha  $\pi k$ ,  $k \in \mathbb{Z}$  davrlar bilan parallel ko'chirishlarni bajarish grafikning kattaroq oraliqdagi davomini beradi (I.35-rasm).

$\operatorname{ctg} x$  funksiyaning grafigi (*kotangensoida*) ham shu kabi yasaladi (I.36-rasm).



## Mashqlar

**1.69.** Quyidagi funksiyalarning xossalarini tekshiring va grafiklarini yasang:

- 1)  $y = \operatorname{ctg} 2x$ ;      2)  $y = \operatorname{ctg}(2x - \frac{\pi}{3})$ ;      3)  $y = \operatorname{ctg} \frac{x}{2}$ ;



- 4)  $y = 2\text{ctgx}$ ;                      5)  $y = |\text{ctg}2x|$ ;                      6)  $y = \frac{1}{2}\text{tg}2x$ ;  
 7)  $y = |\text{tg}2x|$ ;                      8)  $y = \text{tg}2\left(x + \frac{\pi}{4}\right)$ ;                      9)  $y = \text{ctg}|x|$ ;  
 10)  $y = \text{tg}\left|x - \frac{\pi}{6}\right|$ ;                      11)  $y = \lfloor \text{ctgx} \rfloor$ ;                      12)  $y = \{\text{ctgx}\}$ ;  
 13)  $y = \left\lceil \text{tg}\frac{x}{2} \right\rceil$ .

### 3-§. Qo'shish formulalari

**1. Ikki burchak ayirmasining va yig'indisining kosinusi va sinusi.** Chizmada (I.37- rasm)  $\angle BOA = \alpha$ ,  $\angle COA = \beta$ ,  $\varphi = \beta - \alpha$ ,  $BD \perp CE$ ,  $CQ \perp OB$ ,  $DE = BF$ ,  $DB = EF = OF - OE = \cos\alpha - \cos\beta$ ,  $QB = OB - OQ = 1 - \cos\varphi$ ,  $CQ = \sin\varphi$ ,  $CD = CE - BF = \sin\beta - \sin\alpha$ ,  $CDB$  va  $CQB$  to'g'ri burchakli uchburchaklar umumiy  $CB$  gipotenuzaga ega. Pifagor teoremasi bo'yicha:

$$BC^2 = CQ^2 + QB^2 = CD^2 + DB^2$$

yoki

$$\sin^2\varphi + (1 - \cos\varphi)^2 = (\sin\beta - \sin\alpha)^2 + (\cos\alpha - \cos\beta)^2,$$

$$\sin^2\varphi + 1 - 2\cos\varphi + \cos^2\varphi =$$

$$= \sin^2\beta - 2\sin\beta\sin\alpha + \sin^2\alpha + \cos^2\alpha - 2\cos\alpha\cos\beta + \cos^2\beta,$$

$$(\sin^2\varphi + \cos^2\varphi) + 1 - 2\cos\varphi = (\sin^2\beta + \cos^2\beta) + (\sin^2\alpha + \cos^2\alpha) -$$

$$- 2(\sin\alpha\sin\beta - \cos\alpha\cos\beta), \quad 2 - 2\cos\varphi = 2 - 2(\sin\alpha\sin\beta - \cos\alpha\cos\beta)$$

yoki

$$\cos(\beta - \alpha) = \cos\alpha\cos\beta + \sin\alpha\sin\beta. \quad (1)$$

(1) munosabat bo'yicha va funksiyalarning xossalardan foydalanib, yana boshqa formulalarni topish mumkin:

$$\cos(\alpha + \beta) = \cos(\alpha - (-\beta)) =$$

$$= \cos\alpha\cos(-\beta) + \sin\alpha\sin(-\beta),$$

$$\cos(\alpha + \beta) = \cos\alpha\cos\beta - \sin\alpha\sin\beta. \quad (2)$$

Xususan:

$$a) \cos\left(\frac{\pi}{2} - \alpha\right) = \cos\frac{\pi}{2}\cos\alpha +$$

$$+ \sin\frac{\pi}{2}\sin\alpha = 0 \cdot \cos\alpha +$$

$$+ 1 \cdot \sin\alpha = \sin\alpha,$$

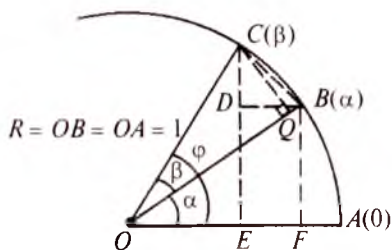

I.37-rasm.

$$\cos\left(\frac{\pi}{2} + \alpha\right) = \cos\frac{\pi}{2} \cos\alpha - \sin\frac{\pi}{2} \sin\alpha = 0 \cdot \cos\alpha - 1 \cdot \sin\alpha = -\sin\alpha;$$

$$\cos\left(\frac{\pi}{2} - \alpha\right) = \sin\alpha; \quad (3)$$

$$\cos\left(\frac{\pi}{2} + \alpha\right) = -\sin\alpha. \quad (4)$$

$$b) \sin\left(\frac{\pi}{2} - \alpha\right) = \cos\left(\frac{\pi}{2} - \left(\frac{\pi}{2} - \alpha\right)\right) = \cos\alpha,$$

$$\sin\left(\frac{\pi}{2} + \alpha\right) = \cos\left(\frac{\pi}{2} - \left(\frac{\pi}{2} + \alpha\right)\right) = \cos(-\alpha) = \cos\alpha.$$

Demak,

$$\sin\left(\frac{\pi}{2} - \alpha\right) = \cos\alpha; \quad (5)$$

$$\sin\left(\frac{\pi}{2} + \alpha\right) = \cos\alpha. \quad (6)$$

$\alpha \pm \beta$  burchak sinusi uchun formulalar yuqorida topilgan formulalardan foydalanib chiqariladi:

$$\begin{aligned} \sin(\alpha + \beta) &= \cos\left(\frac{\pi}{2} - (\alpha + \beta)\right) = \cos\left(\left(\frac{\pi}{2} - \alpha\right) - \beta\right) = \\ &= \cos\left(\frac{\pi}{2} - \alpha\right) \cos\beta + \sin\left(\frac{\pi}{2} - \alpha\right) \sin\beta = \sin\alpha \cos\beta + \cos\alpha \sin\beta \end{aligned}$$

yoki

$$\sin(\alpha + \beta) = \sin\alpha \cos\beta + \cos\alpha \sin\beta. \quad (7)$$

Agar (7) formuladagi  $\beta$  o'rniga  $-\beta$  qo'yilsa, natijada:

$$\sin(\alpha - \beta) = \sin\alpha \cos\beta - \cos\alpha \sin\beta. \quad (8)$$

Misol.  $\cos 150^\circ$  va  $\sin 150^\circ$  ni topamiz.

Yechish. (4) va (6) formulalar bo'yicha:

$$\cos 150^\circ = \cos(90^\circ + 60^\circ) = -\sin 60^\circ = -\frac{\sqrt{3}}{2};$$

$$\sin 150^\circ = \sin(90^\circ + 60^\circ) = \cos 60^\circ = \frac{1}{2}.$$

## Mashqlar

1.70. Hisoblang: 1)  $\sin \frac{\pi}{12}$ ; 2)  $\cos \frac{4\pi}{3}$ ; 3)  $\cos \frac{5\pi}{4}$ ; 4)  $\sin \frac{4\pi}{3}$ .

**1.71.** Agar  $\sin x = \frac{3}{8}$ ;  $\sin t = \frac{4}{9}$ ;  $0 < x < \frac{\pi}{2}$ ;  $\frac{\pi}{2} < t < \pi$  bo'lsa, quyidagilarni toping:

1)  $\sin(x - t)$ ; 2)  $\sin(x + t)$ ; 3)  $\cos(x - t)$ ; 4)  $\cos(x + t)$ .

**1.72.** Agar  $\cos x = -0,8$ ;  $\sin y = 0,4$ ;  $\pi < x < \frac{3\pi}{2}$ ;  $\frac{\pi}{2} < y < \pi$  bo'lsa, quyidagilarni toping:

1)  $\cos(x + y)$ ; 2)  $\cos(x - y)$ ; 3)  $\sin(x + y)$ ; 4)  $\sin(x - y)$ .

**1.73.** Ifodalarni soddalashtiring:

1)  $\cos(x + t)\sin(x - t) + \sin(x + t)\cos(x - t)$ ;

2)  $\cos(\alpha + \beta)\cos(\alpha - \beta) - \sin(\alpha + \beta)\sin(\alpha - \beta)$ ;

3)  $\cos(45^\circ + \alpha)\cos(45^\circ - \alpha) + \sin(45^\circ + \alpha)\sin(45^\circ - \alpha)$ ;

4)  $\frac{\cos(\alpha - \beta) - \sin \alpha \sin \beta}{\sin(\alpha - \beta) + \sin \alpha \cos \beta}$ ; 5)  $\frac{\sin(\beta + \alpha) - 2 \sin \alpha \cos \beta}{\cos(\alpha + \beta) + 2 \sin \alpha \sin \beta}$ ;

6)  $\frac{\cos(\alpha + \beta) + \sin \alpha \sin \beta}{\cos(\alpha + \beta) - \cos \alpha \cos \beta}$ ; 7)  $\frac{\cos(\alpha - \beta) - \sin \alpha \sin \beta}{\cos(\alpha - \beta) - \cos \alpha \cos \beta}$ .

**1.74.** Ayniyatlarni isbot qiling:

1)  $\cos(45^\circ - \alpha) = \frac{\sqrt{2}}{2}(\cos \alpha + \sin \alpha)$ ; 2)  $\frac{\cos(\alpha - \beta)}{\sin \alpha \sin \beta} = \operatorname{ctg} \alpha \operatorname{ctg} \beta + 1$ ;

3)  $\sin(\alpha - \beta)\sin(\alpha + \beta) = \cos^2 \beta - \cos^2 \alpha$ ;

4)  $\sin 2x \cos x + \cos 2x \sin x = \sin 3x$ ;

5)  $\sin(\alpha + \beta) + \cos(\alpha - \beta) = (\sin \alpha + \cos \alpha)(\sin \beta + \cos \beta)$ ;

6)  $\frac{\sin(\alpha - \beta)}{\cos \alpha \cos \beta} + \frac{\sin(\beta - \gamma)}{\cos \beta \cos \gamma} + \frac{\sin(\gamma - \alpha)}{\cos \gamma \cos \alpha} = 0$ .

**1.75.** Funksiyalarning juft-toqligi va davriyligini tekshiring hamda grafiklarini yasang:

1)  $y = \cos x \cos \frac{x}{2} + \sin x \sin \frac{x}{2}$ ; 2)  $y = \sin x \cos \frac{x}{3} - \sin \frac{x}{3} \cos x$ .

**2. Ikki burchak yig'indisi va ayirmasining tangensi va kotangensi.** 1-banddagi formulalardan foydalanamiz. Buning uchun  $\cos(\alpha + \beta) \neq 0$ , ya'ni  $\alpha + \beta \neq \frac{\pi}{2} + \pi k$ ,  $k \in \mathbb{Z}$  va  $\cos \alpha \neq 0$ ,  $\cos \beta \neq 0$  bo'lishi, ya'ni  $\alpha$  va  $\beta$  lar  $\frac{\pi}{2} + \pi k$ ,  $k \in \mathbb{Z}$  ga teng bo'lmashligi kerak. Shu shartlardan quyidagilarga ega bo'lamiz:

$$\operatorname{tg}(\alpha + \beta) = \frac{\sin(\alpha + \beta)}{\cos(\alpha + \beta)} = \frac{\sin \alpha \cos \beta + \cos \alpha \sin \beta}{\cos \alpha \cos \beta - \sin \alpha \sin \beta} = \frac{\frac{\sin \alpha}{\cos \alpha} + \frac{\sin \beta}{\cos \beta}}{1 - \frac{\sin \alpha}{\cos \alpha} \frac{\sin \beta}{\cos \beta}} = \frac{\operatorname{tg} \alpha + \operatorname{tg} \beta}{1 - \operatorname{tg} \alpha \operatorname{tg} \beta}.$$

Bundan:

$$\operatorname{tg}(\alpha + \beta) = \frac{\operatorname{tg} \alpha + \operatorname{tg} \beta}{1 - \operatorname{tg} \alpha \operatorname{tg} \beta}. \quad (1)$$

Xuddi shunday,

$$\operatorname{tg}(\alpha - \beta) = \frac{\operatorname{tg} \alpha - \operatorname{tg} \beta}{1 + \operatorname{tg} \alpha \operatorname{tg} \beta}. \quad (2)$$

Quyidagi formulalar ham shu kabi hosil qilinadi:

$$\operatorname{ctg}(\alpha + \beta) = \frac{\operatorname{ctg} \alpha \operatorname{ctg} \beta - 1}{\operatorname{ctg} \alpha + \operatorname{ctg} \beta}, \quad (3)$$

$$\operatorname{ctg}(\alpha - \beta) = \frac{\operatorname{ctg} \alpha \operatorname{ctg} \beta + 1}{\operatorname{ctg} \alpha - \operatorname{ctg} \beta}. \quad (4)$$

Misol.  $\operatorname{ctg} \frac{7\pi}{12}$  ni hisoblaymiz.

$$\text{Yechish. } \operatorname{ctg} \frac{7\pi}{12} = \operatorname{ctg} \left( \frac{\pi}{3} + \frac{\pi}{4} \right) = \frac{\operatorname{ctg} \frac{\pi}{3} \operatorname{ctg} \frac{\pi}{4} - 1}{\operatorname{ctg} \frac{\pi}{3} + \operatorname{ctg} \frac{\pi}{4}} = \frac{\frac{\sqrt{3}}{3} \cdot 1 - 1}{\frac{\sqrt{3}}{3} + 1} = \frac{\sqrt{3} - 3}{\sqrt{3} + 3} = \frac{1 + \sqrt{3}}{1 - \sqrt{3}}.$$



## Mashqlar

**1.76.** Agar  $\sin(2\alpha + \beta) = 2\sin\beta$  bo'lsa,  $\operatorname{tg}(\alpha + \beta) = 3\operatorname{tg}\alpha$  bo'lishini isbot qiling, bunda  $\beta \neq k\pi$ ,  $k \in \mathbb{Z}$ .

**1.77.** (1)–(4) formulalarning chap qismlarini uning o'ng qismlaridan hosil qiling.

**1.78.** Hisoblang:

1)  $\operatorname{tg} 75^\circ$ ; 2)  $\operatorname{ctg} \frac{5\pi}{12}$ ; 3)  $\operatorname{ctg} 105^\circ$ ; 4)  $\operatorname{tg} 15^\circ$ ; 5)  $\operatorname{ctg} 15^\circ$ .

**1.79.** Berilgan: 1)  $\operatorname{tg} x = 1,5$ ,  $\operatorname{tg} y = -0,5$ ; 2)  $\operatorname{ctg} x = 1,5$ ,  $\operatorname{ctg} y = -0,5$ .  
Topping: 1)  $\operatorname{tg}(x - y)$ ; 2)  $\operatorname{tg}(x + y)$ ; 3)  $\operatorname{ctg}(x - y)$ ; 4)  $\operatorname{ctg}(x + y)$ .

**1.80.** Berilgan:  $\operatorname{tg} \alpha = \frac{1}{3}$ ,  $\operatorname{ctg} \beta = \frac{4}{5}$ ,  $\operatorname{tg} \gamma = 1$ . Hisoblang:

1)  $\operatorname{tg}(\alpha + \beta + \gamma)$ ; 2)  $\operatorname{ctg}(\alpha + \beta + \gamma)$ ; 3)  $\operatorname{tg}(\alpha + \beta - \gamma)$ .

1.81. Hisoblang: 1)  $\frac{\operatorname{tg}26^\circ + \operatorname{tg}34^\circ}{1 - \operatorname{tg}26^\circ \operatorname{tg}34^\circ}$ ; 2)  $\frac{\operatorname{ctg}\frac{\pi}{5} \operatorname{ctg}\frac{9\pi}{20} + 1}{\operatorname{ctg}\frac{\pi}{5} - \operatorname{ctg}\frac{9\pi}{20}}$ .

1.82. Ayniyatlarni isbot qiling:

1)  $\operatorname{tg}\left(\frac{\pi}{4} - x\right) = \frac{1 - \operatorname{tg}x}{1 + \operatorname{tg}x}$ ; 2)  $\operatorname{ctg}\left(\frac{\pi}{4} - x\right) = \frac{\operatorname{ctg}x - 1}{\operatorname{ctg}x + 1}$ ; 3)  $\operatorname{ctg}2\alpha = \frac{\operatorname{ctg}^2\alpha - 1}{2\operatorname{ctg}\alpha}$ ;

4)  $\frac{\operatorname{ctg}\left(\frac{\pi}{3} + \alpha\right) \cdot \operatorname{ctg}\left(\frac{\pi}{3} - \alpha\right) - 1}{\operatorname{ctg}\left(\frac{\pi}{3} + \alpha\right) + \operatorname{ctg}\left(\frac{\pi}{3} - \alpha\right)} = -\frac{\sqrt{3}}{3}$ ; 5)  $\frac{1}{\operatorname{ctg}\alpha \cdot \operatorname{ctg}\beta - 1} - \frac{\operatorname{tg}(\alpha + \beta)}{\operatorname{tg}\alpha + \operatorname{tg}\beta} = -1$

1.83. Ifodalarni soddalashtiring:

1)  $\frac{\operatorname{ctg}(\alpha - \beta) \cdot \operatorname{ctg}\beta - 1}{\operatorname{ctg}\beta + \operatorname{ctg}(\alpha - \beta)}$ ; 2)  $\frac{\operatorname{tg}(\alpha - \beta) - \operatorname{tg}\alpha}{1 + \operatorname{tg}(\alpha - \beta) \operatorname{tg}\alpha}$ ;

3)  $\frac{\operatorname{tg}5x - \operatorname{tg}2x}{1 + \operatorname{tg}5x \cdot \operatorname{tg}2x}$ ; 4)  $\frac{\operatorname{ctg}5x \cdot \operatorname{ctg}4x + 1}{\operatorname{ctg}5x - \operatorname{ctg}4x}$ .

1.84. Ikki egri chiziq orasidagi burchak shu chiziqlarning kesi-shish (umumiy) nuqtasidan o'tkazilgan ikki urinma orasidagi burchakka teng. Quyida ko'rsatilgan funksiyalar grafiklari orasidagi burchak tangensini toping:

1)  $y = x^2$  va  $y = \sqrt{x}$ ; 2)  $y = \frac{6}{x^2 + 1}$  va  $y = x^2$ ;

3)  $y = 3x^2 + 4x - 6$  va  $y = x^2 + x + 3$ ; 4)  $y = x^2$  va  $y = -\frac{2}{x}$ .

1.85.  $ABC$  uchburchakda  $\operatorname{tg}A : \operatorname{tg}B : \operatorname{tg}C = 1 : 2 : 3$ . Shu burchaklarning tangenslari va sinuslarini toping.

**3. Keltirish formulalari.** Oldingi bandlarda  $\pi - \alpha$ ,  $\pi + \alpha$ ,  $\frac{\pi}{2} - \alpha$ ,  $\frac{\pi}{2} + \alpha$  burchaklar sinusi, kosinusi, tangensi, kotangensi uchun formulalar chiqarilgan edi. Ulardan hamda ikki burchak yig'indisi va ayirmasi formulalaridan foydalanib,  $\frac{3\pi}{2} \pm \alpha$ ,  $2\pi \pm \alpha$  burchaklar uchun formulalarni chiqara olamiz. Bu formulalar bir burchak funksiyasini boshqa burchak funksiyalari orqali ifodalashga, xususan, o'tmas burchak funksiyalarini o'tkir burchak funksiyalariga keltirishga imkon beradi. Masalan,

$$\cos\left(\frac{3}{2}\pi + \alpha\right) = \cos\left(\frac{\pi}{2} + (\pi + \alpha)\right) = -\sin(\pi + \alpha) = \sin\alpha. \quad (1)$$

Shu kabi,

$$\sin\left(\frac{3}{2}\pi + \alpha\right) = -\cos \alpha; \quad (2)$$

$$\operatorname{tg}\left(\frac{3}{2}\pi + \alpha\right) = \frac{\sin\left(\frac{3}{2}\pi + \alpha\right)}{\cos\left(\frac{3}{2}\pi + \alpha\right)} = \frac{-\cos \alpha}{\sin \alpha} = -\operatorname{ctg} \alpha; \quad (3)$$

$$\operatorname{ctg}\left(\frac{3}{2}\pi + \alpha\right) = -\operatorname{tg} \alpha. \quad (4)$$

Keltirish formulalari ko'p, ularni esda saqlash maqsadida ushbu *mnemonik qoidadan* ham foydalanamiz (yunoncha *mnemonikon* – ko'p qoidalar majmuasini yodda saqlashni yengillashtiruvchi usul):

1) *agar argument  $2\pi \pm \alpha$  ko'rinishda bo'lsa, trigonometrik funksiyaning nomi o'zgarmaydi;*

2) *agar argument  $\frac{\pi}{2} \pm \alpha$ ,  $\frac{3\pi}{2} \pm \alpha$  ko'rinishda bo'lsa, funksiya-ning nomi o'zgaradi (sinus kosinusga va aksincha, tangens kotangensga va aksincha);*

3) *berilgan trigonometrik funksiya argumenti qaysi chorakda yotgan bo'lsa, funksiyaning o'sha chorakdagi ishorasi izlanayotgan funksiya oldiga qo'yiladi.*

Keltirish formulalarini quyidagi jadval ko'rinishida umumlashtiramiz:

	$\frac{\pi}{2} - \alpha$	$\frac{\pi}{2} + \alpha$	$\pi - \alpha$	$\pi + \alpha$	$\frac{3\pi}{2} - \alpha$	$\frac{3\pi}{2} + \alpha$	$2\pi - \alpha$	$2\pi + \alpha$
$\sin \alpha$	$\cos \alpha$	$\cos \alpha$	$\sin \alpha$	$-\sin \alpha$	$-\cos \alpha$	$-\cos \alpha$	$-\sin \alpha$	$\sin \alpha$
$\cos \alpha$	$\sin \alpha$	$-\sin \alpha$	$-\cos \alpha$	$-\cos \alpha$	$-\sin \alpha$	$\sin \alpha$	$\cos \alpha$	$\cos \alpha$
$\operatorname{tg} \alpha$	$\operatorname{ctg} \alpha$	$-\operatorname{ctg} \alpha$	$-\operatorname{tg} \alpha$	$\operatorname{tg} \alpha$	$\operatorname{ctg} \alpha$	$-\operatorname{ctg} \alpha$	$-\operatorname{tg} \alpha$	$\operatorname{tg} \alpha$
$\operatorname{ctg} \alpha$	$\operatorname{tg} \alpha$	$-\operatorname{tg} \alpha$	$-\operatorname{ctg} \alpha$	$\operatorname{ctg} \alpha$	$\operatorname{tg} \alpha$	$-\operatorname{tg} \alpha$	$-\operatorname{ctg} \alpha$	$\operatorname{ctg} \alpha$

Misol. a)  $\cos(15\pi + \alpha)$ ; b)  $\operatorname{tg}(\pi + \alpha)$  ifodalarni o'tkir burchak trigonometrik funksiya ko'rinishiga keltiramiz,  $0 < \alpha < \frac{\pi}{2}$ .

Yechish. a)  $\cos(7 \cdot 2\pi + \pi + \alpha) = \cos(\pi + \alpha)$ . Bunda  $\pi + \alpha$  burchak, demak,  $15\pi + \alpha$  burchak ham, uchinchi chorakka qarashli. Bu chorakda kosinusning ishorasi manfiy, hosil bo'ladigan funksiyaning nomi kosinusligicha qoladi. Demak,  $\cos(15\pi + \alpha) = -\cos \alpha$ ;

b) uchinchi chorakda tangens musbat. Natijada  $\operatorname{tg}(\pi + \alpha) = \operatorname{tg} \alpha$  hosil bo'ladi.



## Mashqlar

**1.86.** Bir necha keltirish formulasini geometrik usulda isbotlang.

**1.87.** Ifodaning qiymatini toping:

- 1)  $\sin 1080^\circ$ ;      2)  $\cos 1080^\circ$ ;      3)  $\operatorname{tg} 1080^\circ$ ;  
 4)  $\operatorname{ctg} 1080^\circ$ ;      5)  $1080^\circ$  li yoy sahmini;      6)  $\sin\left(7\frac{5}{6}\pi\right)$ ;  
 7)  $\cos\left(-\frac{49}{6}\pi\right)$ ;      8)  $\operatorname{tg}\left(-\frac{29}{8}\pi\right)$ ;      9)  $\operatorname{ctg}\left(-\frac{32}{3}\pi\right)$ .

**1.88.** Ifodalarni soddalashtiring:

1)  $\sin\left(-\frac{55\pi}{3}\right)\cos\left(\frac{51\pi}{4}\right) - \sin\left(\frac{73\pi}{3}\right)\cos\left(\frac{101\pi}{4}\right)$ ;      2)  $\frac{\operatorname{tg}\left(-\frac{32\pi}{3}\right)\operatorname{tg}\left(\frac{47\pi}{4}\right)}{1 - \operatorname{ctg}\left(\frac{17\pi}{6}\right)\operatorname{ctg}\left(\frac{21\pi}{4}\right)}$ .

**1.89.** Ayniyatlarni isbot qiling:

1)  $\frac{2\sin\left(\frac{5\pi}{2} + \alpha\right)\cos(16\pi + \beta)}{\cos(\alpha - \beta) + 2\cos\left(\frac{5\pi}{2} + \alpha\right)\cos\left(\frac{7\pi}{2} + \beta\right)} = \sqrt{\frac{1 + \operatorname{tg}^2(\pi + \alpha + \beta)}{1 - \operatorname{tg}^2(\pi - \alpha + \beta)}}$ ;

2)  $\frac{\sin\left(\frac{9\pi}{2} + \alpha\right) + \cos\left(\frac{11\pi}{2} + \alpha\right)}{2(\cos(4\pi + \alpha) + \sin \alpha)} \cdot (\sin(5\pi + \alpha) + \cos(9\pi - \alpha)) = -\frac{1}{2}$ ;

3)  $\frac{\sin(11\pi - x)\cos\left(\frac{7\pi}{2} + x\right)\operatorname{tg}\left(x - \frac{19\pi}{2}\right)}{\cos\left(\frac{19\pi}{2} - x\right)\cos\left(\frac{15\pi}{2} - x\right)\operatorname{tg}(x - 11\pi)} = -\operatorname{ctg}^2 x$ .

**4. Ikkilangan va uchlangan argumentning trigonometrik funksiyalari.** Agar  $\alpha + \beta$  burchak trigonometrik funksiyalari formulalarida  $\alpha = \beta$  deyilsa,  $2\alpha$  burchak trigonometrik funksiyalari formulalari hosil qilinadi. Ular  $2\alpha$  argument funksiyasini  $\alpha$  argument funksiyasi orqali ifodalashga imkon beradi:

$$\sin 2\alpha = 2\sin\alpha\cos\alpha; \quad (1) \quad \cos 2\alpha = \cos^2\alpha - \sin^2\alpha; \quad (2)$$

$$\operatorname{tg} 2\alpha = \frac{2\operatorname{tg}\alpha}{1 - \operatorname{tg}^2\alpha}; \quad (3) \quad \operatorname{ctg} 2\alpha = \frac{\operatorname{ctg}^2\alpha - 1}{2\operatorname{ctg}\alpha}. \quad (4)$$

Aksincha,  $\alpha$  argument funksiyasini  $2\alpha$  funksiyasi orqali ham berish mumkin. Chunonchi,  $1 = \sin^2\alpha + \cos^2\alpha$  ayniyat va (2) formula bo'yicha  $1 + \cos 2\alpha = 2\cos^2\alpha$  va  $1 - \cos 2\alpha = 2\sin^2\alpha$  yoki



$$\cos 2\alpha = 2\cos^2\alpha - 1 \quad (5)$$

va

$$\cos 2\alpha = 1 - 2\sin^2\alpha \quad (6)$$

hosil qilinadi. (5) va (6) formulalarni quyidagi ko'rinishda ham yozish mumkin:

$$\cos^2\alpha = \frac{1 + \cos 2\alpha}{2}; \quad (7)$$

$$\sin^2\alpha = \frac{1 - \cos 2\alpha}{2}. \quad (8)$$

Agar  $\cos\alpha \neq 0$  bo'lsa, (1) tenglikning o'ng qismini  $\sin^2\alpha + \cos^2\alpha$  ga, ya'ni 1 ga, so'ng surat va maxrajni  $\cos^2\alpha$  ga bo'lsak, quyidagini hosil qilamiz:

$$\sin 2\alpha = \frac{2\sin\alpha\cos\alpha}{\sin^2\alpha + \cos^2\alpha} = \frac{2\sin\alpha\cos\alpha}{\frac{\cos^2\alpha}{\sin^2\alpha + \cos^2\alpha} \cdot \cos^2\alpha},$$

bundan:

$$\sin 2\alpha = \frac{2\operatorname{tg}\alpha}{1 + \operatorname{tg}^2\alpha}. \quad (9)$$

Shu kabi:

$$\cos\alpha \neq 0 \text{ da } \cos 2\alpha = \frac{1 - \operatorname{tg}^2\alpha}{1 + \operatorname{tg}^2\alpha}. \quad (10)$$

Shuningdek,  $\operatorname{ctg} 2\alpha = \frac{1}{\operatorname{tg} 2\alpha}$  va (3) formula bo'yicha:

$$\operatorname{ctg} 2\alpha = \frac{1 - \operatorname{tg}^2\alpha}{2\operatorname{tg}\alpha}, \quad a \neq \frac{\pi k}{2}, \quad k \in Z. \quad (11)$$

Uchlangan argument  $3\alpha$  ning trigonometrik funksiyalarini yuqorida topilgan formulalardan foydalanib topish mumkin. Masalan,

$$\begin{aligned} \sin 3\alpha &= \sin(2\alpha + \alpha) = \sin 2\alpha \cos\alpha + \cos 2\alpha \sin\alpha = \\ &= 2\sin\alpha \cos^2\alpha + (1 - 2\sin^2\alpha)\sin\alpha = \sin\alpha(2(\cos^2\alpha - \sin^2\alpha) + 1) = \\ &= \sin\alpha(2(1 - 2\sin^2\alpha) + 1) = \sin\alpha(3 - 4\sin^2\alpha), \\ \sin 3\alpha &= \sin\alpha(3 - 4\sin^2\alpha). \end{aligned} \quad (12)$$

Shu kabi:  $\cos 3\alpha = \cos\alpha(4\cos^2\alpha - 3)$ .



## Mashqlar

**1.90.**  $\sin \alpha = -0,83$ ,  $\pi < \alpha < \frac{3\pi}{2}$  bo'yicha  $\sin 2\alpha$ ,  $\cos 2\alpha$ ,  $\operatorname{tg} 2\alpha$  ni

toping.

**1.91.**  $\cos \alpha = -0,4$ ,  $\sin \alpha < 0$  bo'yicha  $\sin 2\alpha$ ,  $\cos 2\alpha$ ,  $\operatorname{tg} 2\alpha$  ni

toping.

**1.92.**  $\operatorname{tg} \alpha = -3$  bo'yicha  $\operatorname{ctg} 2\alpha$  ni toping.

**1.93.** Agar  $0 < \alpha < \frac{\pi}{2}$  bo'lsa,  $\sin 2\alpha < 2\sin \alpha$  bo'lishini isbot qiling.

**1.94.**  $\operatorname{ctg} \alpha = -1,2$ ,  $\frac{\pi}{2} < \alpha < \pi$  bo'yicha  $\sin 3\alpha$ ,  $\cos 3\alpha$ ,  $\cos 4\alpha$ ,  $\operatorname{tg} 4\alpha$

ni toping.

**1.95.** Agar  $\operatorname{tg} \alpha = 0,3$ ,  $\operatorname{tg} \beta = 0,4$  bo'lsa,  $\operatorname{tg}(2\alpha - \beta)$  ni toping.

**1.96.** Ayniyatlarni isbot qiling:

$$1) \frac{\cos 2t + 1 - \cos^2 t}{\cos\left(\frac{5\pi}{2} + 2t\right)} = -\frac{1}{2} \operatorname{ctg} t; \quad 2) \frac{2 \sin 2t - \sin 4t}{\sin 4t + 2 \sin 2t} = \operatorname{tg}^2 t;$$

$$3) \frac{\sin 2t + \operatorname{tg} 2t}{\operatorname{tg} 2t} = 2 \cos^2 t; \quad 4) \frac{1 - 2 \cos^2 2t}{\frac{1}{2} \sin 4t} = \operatorname{tg} 2t - \operatorname{ctg} t;$$

$$5) \frac{\cos t + \operatorname{ctg} t}{\operatorname{ctg} t} = 1 + \sin 2t; \quad 6) \frac{2 \cos^2 t - 1}{2 \operatorname{ctg}\left(\frac{\pi}{4} - t\right) \sin^2\left(\frac{\pi}{4} - t\right)} = 1;$$

$$7) 1 + \cos t = \frac{\sin t + \operatorname{tg} t}{\operatorname{tg} t}; \quad 8) \frac{2 \sin 4t(1 - \operatorname{tg}^2 2t)}{1 + \operatorname{ctg}^2\left(\frac{\pi}{2} + 2t\right)} = \sin 8t;$$

$$9) \frac{\cos 2t + 5 \cos 3t + \cos 4t}{\sin 2t + 5 \sin 3t + \sin 4t} = \operatorname{ctg} 3t; \quad 10) \operatorname{tg} 55^\circ \operatorname{tg} 65^\circ \operatorname{tg} 75^\circ = \operatorname{tg} 85^\circ.$$

**1.97.** Ifodalarni soddalashtiring:

$$1) \cos \frac{\pi}{15} \cos \frac{2\pi}{15} \cos \frac{3\pi}{15} \cos \frac{4\pi}{15} \cos \frac{5\pi}{15} \cos \frac{6\pi}{15} \cos \frac{7\pi}{15};$$

$$2) \sin\left(\alpha - \frac{5\pi}{2}\right) \cos \alpha - \sin^2(5\pi - \alpha) \sin^2 \alpha - \cos^2(5\pi - \alpha) \cos^2\left(\frac{11\pi}{2} + \alpha\right);$$

$$3) 2 \operatorname{ctg}\left(\frac{13\pi}{2} - 2\alpha\right) + \frac{2 \sin(17\pi - \alpha)}{\sin\left(\frac{15\pi}{2} + \alpha\right) + \operatorname{tg} \alpha \sin(-\alpha)};$$

$$4) \frac{2 \cos \alpha - \sin 2\alpha}{\sin^2 3\alpha - \sin \alpha + \cos^2 3\alpha}; \quad 5) \frac{\sin^4 2t + 2 \cos 2t \sin 2t - \cos^4 2t}{2 \cos^2 2t - 1};$$

$$6) 1 + 2\cos 2\alpha + 2\cos 4\alpha + 2\cos 6\alpha;$$

$$7) \cos\left(\frac{7\pi}{2} - 2\alpha\right) \operatorname{tg}(5\pi - \alpha) + \sin\left(\frac{17\pi}{2} + 2\alpha\right); \quad 8) \frac{(1 + \operatorname{tg} 2\alpha) \cos\left(\frac{\pi}{4} + 2\alpha\right)}{1 - \operatorname{tg} 2\alpha}.$$

**5. Yarim argumentning trigonometrik funksiyalari.** Bu formulalar oldingi badda berilgan (4)–(11) formulalardagi  $\alpha$  o'rniga  $\frac{\alpha}{2}$  ni qo'yish orqali hosil qilinadi. Jumladan, (7), (8) formulalar bo'yicha  $\cos^2 \frac{\alpha}{2} = \frac{1 + \cos \alpha}{2}$ ,  $\sin^2 \frac{\alpha}{2} = \frac{1 - \cos \alpha}{2}$  yoki

$$\left| \cos \frac{\alpha}{2} \right| = \sqrt{\frac{1 + \cos \alpha}{2}}; \quad (1)$$

$$\left| \sin \frac{\alpha}{2} \right| = \sqrt{\frac{1 - \cos \alpha}{2}}. \quad (2)$$

Agar (2) tenglik (1) ga hadma-had bo'linsa:

$$\left| \operatorname{tg} \frac{\alpha}{2} \right| = \sqrt{\frac{1 - \cos \alpha}{1 + \cos \alpha}} \quad (3)$$

tenglik hosil bo'ladi.  $\operatorname{ctg} \alpha = \frac{1}{\operatorname{tg} \alpha}$  bo'lgani uchun

$$\left| \operatorname{ctg} \frac{\alpha}{2} \right| = \sqrt{\frac{1 + \cos \alpha}{1 - \cos \alpha}}. \quad (4)$$

tenglik ham o'rinlidir.

(1)–(4) formulalar trigonometrik funksiyalar qiymatlarining modulini topishga imkon beradi. Ularning ishoralari esa  $\frac{\alpha}{2}$  argumentning qaysi chorakka tegishli ekaniga bog'liq.

Misol.  $\sin \alpha = \frac{\sqrt{5}}{3}$ ,  $\frac{\pi}{2} \leq \alpha \leq \pi$  ekani ma'lum.  $\sin \frac{\alpha}{2}$ ,  $\cos \frac{\alpha}{2}$ ,  $\operatorname{tg} \frac{\alpha}{2}$  ni topamiz.

Yechish. Shartdan foydalanib  $\frac{\pi}{4} \leq \frac{\alpha}{2} \leq \frac{\pi}{2}$  bo'lishini aniqlaymiz. Bu oraliqda barcha trigonometrik funksiyalar musbat. Yuqorida topilgan formulalardan foydalanamiz. Oldin  $\cos \alpha$  ni topaylik:

$$\cos \alpha = \sqrt{1 - \sin^2 \alpha} = -\sqrt{1 - \frac{5}{9}} = -\frac{2}{3}.$$

U holda:

$$\cos \frac{\alpha}{2} = \sqrt{\frac{1 + \left(-\frac{2}{3}\right)}{2}} = \frac{1}{\sqrt{6}}, \quad \sin \frac{\alpha}{2} = \sqrt{\frac{1 - \left(-\frac{2}{3}\right)}{2}} = \sqrt{\frac{5}{6}}, \quad \operatorname{tg} \frac{\alpha}{2} = \sqrt{5}.$$

Yarim argumentning tangensi uchun yana bir formula hosil qilish maqsadida  $\operatorname{tg} \frac{\alpha}{2} = \frac{\sin \frac{\alpha}{2}}{\cos \frac{\alpha}{2}}$  tenglikning o'ng qismidagi kasr surat va maxrajini  $2\sin \frac{\alpha}{2}$  ga ko'paytiramiz:

$$\operatorname{tg} \frac{\alpha}{2} = \frac{2\sin^2 \frac{\alpha}{2}}{2\cos \frac{\alpha}{2} \sin \frac{\alpha}{2}} = \frac{2 \cdot \frac{1-\cos \alpha}{2}}{\sin \left(2 \cdot \frac{\alpha}{2}\right)} = \frac{1-\cos \alpha}{\sin \alpha},$$

$$\operatorname{tg} \frac{\alpha}{2} = \frac{1-\cos \alpha}{\sin \alpha}. \quad (5)$$

Agar surat va maxraj  $2\cos \frac{\alpha}{2}$  ga ko'paytirilsa,

$$\operatorname{tg} \frac{\alpha}{2} = \frac{\sin \alpha}{1+\cos \alpha}. \quad (6)$$

(5) va (6) formulalar bo'yicha:

$$\operatorname{ctg} \frac{\alpha}{2} = \frac{\sin \alpha}{1-\cos \alpha} = \frac{1+\cos \alpha}{\sin \alpha}. \quad (7)$$



## Mashqlar

**1.98.** Berilgan: 1)  $\alpha = \frac{\pi}{6}$ ; 2)  $\alpha = \frac{\pi}{4}$ ; 3)  $\cos \alpha = -0,4$ ,  $\frac{\pi}{2} < \alpha < \pi$ ;

4)  $\operatorname{ctg} \alpha = 4$ ,  $\pi < \alpha < \frac{3}{2}\pi$ ; 5)  $\sin \alpha = 0,8$ ;  $450^\circ < \alpha < 540^\circ$ .

Toping:  $\sin \frac{\alpha}{2}$ ;  $\cos \frac{\alpha}{2}$ ;  $\operatorname{tg} \frac{\alpha}{2}$ .

**1.99.**  $\sin 15^\circ$ ,  $\cos 15^\circ$ ,  $\sin 18^\circ$ ,  $\cos 18^\circ$ ,  $\sin 12^\circ$ ,  $\cos 12^\circ$  lar hisoblansin.

**1.100.** Ifodalarni soddalashtiring:

1)  $\sqrt{\frac{1-\cos 6\alpha}{2}}$ ; 2)  $\sqrt{1+\cos 10x}$ ; 3)  $2\cos^2 \frac{\alpha}{2} - \cos \alpha$ ;

4)  $\frac{1+\cos 4\alpha}{\sin 4\alpha}$ ; 5)  $\sqrt{\frac{\sin\left(\frac{7\pi}{2}-\alpha\right)+1}{\sin\left(\frac{5\pi}{2}+\alpha\right)+1}}$ .

**1.101.** Ayniyatlarni isbot qiling:

1)  $1 - \cos\left(\frac{\pi}{2} + \alpha\right) = 2\cos^2\left(\frac{\pi}{4} - \frac{\alpha}{2}\right)$ ;

$$2) 1 + \cos\left(\frac{5\pi}{2} + \alpha\right) = 2 \sin^2\left(\frac{\pi}{4} - \frac{\alpha}{2}\right); \quad 3) \frac{\operatorname{tg}\left(\pi - \frac{\alpha}{2}\right) - \operatorname{ctg}\frac{\alpha}{2}}{\operatorname{tg}\frac{\alpha}{2} + \operatorname{ctg}\left(\pi - \frac{\alpha}{2}\right)} = -\cos\alpha;$$

$$4) \operatorname{tg}\left(\pi - \frac{\alpha}{2}\right) + \operatorname{ctg}\frac{\alpha}{2} = 2\operatorname{ctg}\alpha; \quad 5) \sin^4\alpha + \cos^4\alpha = \frac{3 + \cos 4\alpha}{4};$$

$$6) \cos^4\alpha - \sin^4\alpha = \cos 2\alpha.$$

**6. Trigonometrik funksiyalarni yarim argument tangensi orqali ifodalash.**  $\sin\alpha$  va  $\cos\alpha$  ni  $\operatorname{tg}\frac{\alpha}{2}$  orqali ifodalashda  $\sin\alpha = 2 \sin\frac{\alpha}{2} \cdot \cos\frac{\alpha}{2}$ ,  $\cos\alpha = \cos^2\frac{\alpha}{2} - \sin^2\frac{\alpha}{2}$  va  $\sin^2\frac{\alpha}{2} + \cos^2\frac{\alpha}{2} = 1$

formulalardan foydalanamiz.  $\sin\alpha = \frac{2 \sin\frac{\alpha}{2} \cdot \cos\frac{\alpha}{2}}{\cos^2\frac{\alpha}{2} + \sin^2\frac{\alpha}{2}}$  tenglikka ega-miz. Bu tenglikdagi kasrning surat va maxrajini  $\cos^2\frac{\alpha}{2} \neq 0$  ga bo'lib,

$$\sin\alpha = \frac{2 \operatorname{tg}\frac{\alpha}{2}}{1 + \operatorname{tg}^2\frac{\alpha}{2}} \quad (1)$$

tenglikni hosil qilamiz. Xuddi shu kabi,  $\cos\alpha = \frac{\cos^2\frac{\alpha}{2} - \sin^2\frac{\alpha}{2}}{\cos^2\frac{\alpha}{2} + \sin^2\frac{\alpha}{2}}$  tenglik yordamida quyidagi tenglik hosil qilinadi:

$$\cos\alpha = \frac{1 - \operatorname{tg}^2\frac{\alpha}{2}}{1 + \operatorname{tg}^2\frac{\alpha}{2}} \quad (2)$$

$\operatorname{tg}\alpha$  va  $\operatorname{ctg}\alpha$  ni  $\operatorname{tg}\frac{\alpha}{2}$  orqali ifodalash uchun (1) ni (2) ga va aksincha, (2) ni (1) ga hadma-had bo'lish yetarli. Natijada quyidagi tengliklarga ega bo'lamiz:

$$\operatorname{tg}\alpha = \frac{2 \operatorname{tg}\frac{\alpha}{2}}{1 - \operatorname{tg}^2\frac{\alpha}{2}}, \quad (3)$$

$$\operatorname{ctg}\alpha = \frac{1 - \operatorname{tg}^2\frac{\alpha}{2}}{2 \operatorname{tg}\frac{\alpha}{2}}. \quad (4)$$

Misol. Agar  $\operatorname{tg}\frac{\alpha}{2} = -\frac{2}{3}$  bo'lsa,  $\frac{2+3\cos\alpha}{4-5\sin\alpha}$  ni hisoblang.

Yechish. (1) va (2) formulalarga ko'ra,

$$\sin \alpha = \frac{2 \cdot \left(-\frac{2}{3}\right)}{1 - \left(-\frac{2}{3}\right)^2} = -\frac{12}{13}, \quad \cos \alpha = \frac{1 - \frac{4}{9}}{1 + \frac{4}{9}} = \frac{5}{13}.$$

Bundan  $\frac{2+3 \cos \alpha}{4-5 \sin \alpha} = \frac{2+\frac{15}{13}}{4+\frac{60}{13}} = \frac{41}{112}.$

## Mashqlar

1.102. Ifodani soddalashtiring:

i)  $\frac{\operatorname{tg} \alpha \cdot \cos 2 \alpha}{1 + \operatorname{tg}^2 \alpha};$       2)  $\frac{\cos 2 \alpha - \cos 2 \alpha \cdot \operatorname{tg}^2 \alpha}{1 + \operatorname{tg}^2 \alpha}.$

1.103.  $\operatorname{tg} \frac{x}{2} = \frac{1}{2}$  bo'lsa,  $\sin x$ ,  $\cos x$ ,  $\operatorname{tg} x$ ,  $\operatorname{ctg} x$  ni toping.

1.104.  $\sin x + \cos x = \frac{1}{5}$  bo'lsa,  $\operatorname{tg} \frac{x}{2}$  ni toping.

1.105. Ayniyatni isbotlang:

1)  $\frac{\cos \alpha}{1 - \sin \alpha} = \frac{1 + \operatorname{tg} \frac{\alpha}{2}}{1 - \operatorname{tg} \frac{\alpha}{2}};$

2)  $\frac{\cos \alpha}{1 + \sin \alpha} = \frac{\operatorname{ctg} \frac{\alpha}{2} - 1}{\operatorname{ctg} \frac{\alpha}{2} + 1};$

3)  $\left( \frac{\operatorname{tg} \frac{\alpha}{2} + 1}{\operatorname{tg} \frac{\alpha}{2} - 1} \right)^2 = \frac{1 + \sin \alpha}{1 - \sin \alpha};$

4)  $\frac{1 + \sin \alpha + \cos \alpha}{1 + \sin \alpha - \cos \alpha} = \operatorname{ctg} \frac{\alpha}{2};$

5)  $\cos^2 \frac{\alpha}{2} \left( 1 + \operatorname{tg} \frac{\alpha}{2} \right)^2 = 1 + \sin \alpha;$       6)  $\sin^2 \frac{\alpha}{2} \left( \operatorname{ctg} \frac{\alpha}{2} - 1 \right)^2 = 1 - \sin \alpha.$

**7. Trigonometrik funksiyalar yig'indisini ko'paytmaga va ko'paytmasini yig'indiga aylantirish.** Ikki burchak yig'indisi va ayirmasi sinusi munosabatlarini hadma-had qo'shaylik:

$$\sin(\alpha + \beta) = \sin \alpha \cos \beta + \cos \alpha \sin \beta$$

$$\sin(\alpha - \beta) = \sin \alpha \cos \beta - \cos \alpha \sin \beta$$

---

$$\sin(\alpha + \beta) + \sin(\alpha - \beta) = 2 \sin \alpha \cos \beta,$$

bundan:

$$\sin \alpha \cos \beta = \frac{1}{2} (\sin(\alpha + \beta) + \sin(\alpha - \beta)). \quad (1)$$

Shu kabi ikki burchak kosinusi yig'indisi va ayirmasi munosabatlarini hadma-had qo'shsak va ayirsak, quyidagi formulalar hosil bo'ladi:

$$\cos \alpha \cos \beta = \frac{1}{2} (\cos(\alpha + \beta) + \cos(\alpha - \beta)), \quad (2)$$

$$\sin \alpha \sin \beta = \frac{1}{2} (\cos(\alpha - \beta) - \cos(\alpha + \beta)). \quad (3)$$

Trigonometrik funksiyalar ko'paytmasini yig'indi yoki ayirma ko'rinishiga keltirish maqsadida  $\alpha + \beta = u$ ,  $\alpha - \beta = v$  deb olamiz.

Bulardan  $\alpha = \frac{u+v}{2}$ ,  $\beta = \frac{u-v}{2}$  larni topib, (1) formulaga qo'ysak, natijada:

$$\sin u + \sin v = 2 \sin \frac{u+v}{2} \cos \frac{u-v}{2}. \quad (4)$$

(4) formulada  $v$  ni  $-v$  ga almashtirsak,

$$\sin u - \sin v = 2 \sin \frac{u-v}{2} \cos \frac{u+v}{2}. \quad (5)$$

(2) va (3) formulalar bo'yicha quyidagi tengliklar hosil bo'ladi:

$$\cos u + \cos v = 2 \cos \frac{u+v}{2} \cos \frac{u-v}{2}, \quad (6)$$

$$\cos u - \cos v = -2 \sin \frac{u+v}{2} \sin \frac{u-v}{2}. \quad (7)$$

l - m i s o l.  $\cos 45^\circ + \cos 15^\circ$  ni hisoblaymiz.

Y e c h i s h. (6) formula bo'yicha:

$$\begin{aligned} \cos 45^\circ + \cos 15^\circ &= 2 \cos \frac{45^\circ + 15^\circ}{2} \cos \frac{45^\circ - 15^\circ}{2} = \\ &= 2 \cos 60^\circ \cos 30^\circ = 2 \cdot \frac{1}{2} \cdot \frac{\sqrt{3}}{2} = \frac{\sqrt{3}}{2}. \end{aligned}$$

Tangens va kotangensga taalluqli formulalarni chiqaraylik:

$$\operatorname{tg} u + \operatorname{tg} v = \frac{\sin u}{\cos u} + \frac{\sin v}{\cos v} = \frac{\sin u \cos v + \cos u \sin v}{\cos u \cos v} = \frac{\sin(u+v)}{\cos u \cos v},$$

bundan

$$\operatorname{tg} u + \operatorname{tg} v = \frac{\sin(u+v)}{\cos u \cos v}, \quad u, v \neq \frac{\pi}{2} + \pi k, \quad k \in Z. \quad (8)$$

Quyidagi formulalar ham shu tartibda keltirib chiqariladi:

$$\operatorname{tg} u - \operatorname{tg} v = \frac{\sin(u-v)}{\cos u \cos v}, \quad u, v \neq \frac{\pi}{2} + \pi k, \quad k \in Z, \quad (9)$$



$$\operatorname{ctgu} + \operatorname{ctgv} = \frac{\sin(u+v)}{\sin u \sin v}, \quad u, v \neq \pi k, \quad k \in Z, \quad (10)$$

$$\operatorname{ctgu} - \operatorname{ctgv} = \frac{\sin(u-v)}{\sin u \sin v}, \quad u, v \neq \pi k, \quad k \in Z. \quad (11)$$

2-misol. Agar  $u + v + w = \pi$  bo'lsa,  $\operatorname{ctgu} + \operatorname{ctgv} - \operatorname{tg}w = -\operatorname{ctgu} \operatorname{ctgv} \operatorname{tg}w$  bo'lishini isbot qilamiz.

Yechish.

$$\begin{aligned} \operatorname{ctgu} + \operatorname{ctgv} - \operatorname{tg}w &= \operatorname{ctgu} + \operatorname{ctgv} - \operatorname{tg}(\pi - (u+v)) = \operatorname{ctgu} + \operatorname{ctgv} + \operatorname{tg}(u+v) = \\ &= \frac{\sin(u+v)}{\sin u \sin v} + \frac{\sin(u+v)}{\cos(u+v)} = \frac{\sin(u+v)(\cos(u+v) + \sin u \sin v)}{\sin u \sin v \cos(u+v)} = \frac{\sin(u+v) \cos u \cos v}{\sin u \sin v \cos(u+v)} = \\ &= \operatorname{ctgu} \operatorname{ctgv} \operatorname{tg}(u+v) = \operatorname{ctgu} \operatorname{ctgv} \operatorname{tg}(\pi - w) = -\operatorname{ctgu} \operatorname{ctgv} \operatorname{tg}w \end{aligned}$$



## Mashqlar

**1.106.** Trigonometrik funksiyalar yig'indisi ko'rinishida yozing:

- 1)  $2\sin 22^\circ \cos 12^\circ$ ;                      2)  $\sin x \sin(x-1)$ ;  
3)  $4\sin 35^\circ \cos 25^\circ \sin 15^\circ$ ;            4)  $8\cos 3^\circ \cos 6^\circ \cos 12^\circ \cos 24^\circ$ .

**1.107.** Hisoblang:

- 1)  $\cos 80^\circ \cos 40^\circ \cos 20^\circ$ ;            2)  $\operatorname{tg} 35^\circ \operatorname{tg} 55^\circ$ .  
3)  $\frac{2\cos 80^\circ - \cos 20^\circ}{\sin 10^\circ}$ ;                      4)  $\cos 20^\circ \cos 40^\circ \cos 80^\circ$ ;  
5)  $\cos 9^\circ \cos 27^\circ \cos 63^\circ \cos 81^\circ$ ;    6)  $\sin 20^\circ \sin 40^\circ \sin 60^\circ \sin 80^\circ$ .

**1.108.** Ko'paytma yoki ko'paytmalar ko'rinishida tasvirlang:

- 1)  $\cos 43^\circ + \cos 37^\circ$ ;                      2)  $\sin 76^\circ - \sin 26^\circ$ ;  
3)  $\sin 57^\circ - \cos 64^\circ$ ;                      4)  $\sin 18^\circ + \cos 15^\circ$ ;  
5)  $\sin \frac{\pi}{5} - \cos \frac{\pi}{7}$ ;                          6)  $\cos 6x + \cos 4x$ ;  
7)  $\cos^2 \alpha - \cos^2 \beta$ ;                      8)  $\cos \alpha - \cos \beta$ ;  
9)  $\operatorname{ctg}^2 \alpha - \operatorname{ctg}^2 \beta$ ;                      10)  $\cos x + \cos 3x + \cos 5x + \cos 7x$ ;  
11)  $\sin x + \sin 2x + \sin 3x + \sin 4x$ ;  
12)  $\sin 20^\circ + \sin 10^\circ + \sin 30^\circ$ ;  
13)  $\cos \alpha + \cos \beta + \sin \frac{\alpha+\beta}{2}$ ;            14)  $\sin 2x - \cos x - \sin 5x$ ;  
15)  $\cos\left(\frac{\pi}{10} + x\right) - \cos\left(\frac{\pi}{10} - x\right) - \sin x$ ;

$$16) \sin(5\alpha + \beta) + \sin(3\alpha + \beta) + \sin 2\alpha;$$

$$17) \sqrt{\operatorname{ctg}\alpha + \cos\alpha} + \sqrt{\operatorname{ctg}\alpha - \cos\alpha}, \quad 0 < \alpha < \frac{\pi}{2};$$

$$18) 1 - \operatorname{ctg}\alpha; \quad 19) 1 + \operatorname{ctg}\alpha;$$

$$20) 1 - \operatorname{tg}\alpha; \quad 21) 1 - \sin(\pi - x) + \cos(\pi - x);$$

$$22) \operatorname{ctg}\alpha + \operatorname{ctg}2\alpha - \operatorname{tg}3\alpha.$$

**1.109.** Ayniyatni isbot qiling:

$$1) \frac{\sin(t+s) - \sin(t-s)}{\sin(t+s) + \sin(t-s)} = \operatorname{ctg}t \operatorname{ctg}s;$$

$$2) 2(1 + \sin t \sin s + \cos t \cos s) = 4 \cos^2 \frac{t-s}{2}.$$

$$3) (\sin 3t + \sin 5t)^2 + (\cos 3t + \cos 5t)^2 = 4 \cos^2 t;$$

$$4) \operatorname{tg}20^\circ + \operatorname{tg}40^\circ + \operatorname{tg}80^\circ - \operatorname{tg}60^\circ = 8 \cos 50^\circ;$$

$$5) \operatorname{ctg}^6 20^\circ - 9 \operatorname{ctg}^4 20^\circ + 11 \operatorname{ctg}^2 20^\circ = \frac{1}{3};$$

$$6) \cos 9^\circ \cos 27^\circ \cos 63^\circ \cos 81^\circ + \cos 12^\circ \cos 24^\circ \cos 48^\circ \cos 96^\circ = 0;$$

$$7) \sin \alpha + \sin 2\alpha + \sin 3\alpha + \dots + \sin n\alpha = \frac{\sin \frac{n\alpha}{2} \sin \frac{(n+1)\alpha}{2}}{\sin \frac{\alpha}{2}};$$

$$8) \cos \alpha + \cos 2\alpha + \cos 3\alpha + \dots + \cos n\alpha = \frac{\sin \frac{n\alpha}{2} \cos \frac{(n+1)\alpha}{2}}{\sin \frac{\alpha}{2}};$$

$$9) \text{ Agar } \sin \alpha + \sin \beta = 2 \sin(\alpha + \beta) \text{ va } \frac{\alpha + \beta}{2} \neq k\pi \text{ bo'lsa,}$$

$$\operatorname{tg} \frac{\alpha}{2} + \operatorname{tg} \frac{\beta}{2} = \frac{1}{3} \text{ bo'ladi;}$$

$$10) \text{ Agar } 0 \leq x \leq \frac{\pi}{2} \text{ bo'lsa, } \sqrt{1 + \sin x} - \sqrt{1 - \sin x} = 2 \sin \frac{x}{2}$$

bo'ladi.

**1.110.** Yig'indini hisoblang:

$$1) \cos \alpha + 2 \cos 2\alpha + 3 \cos 3\alpha + \dots + n \cos n\alpha;$$

$$2) \frac{1}{\cos \alpha \cos 2\alpha} + \frac{1}{\cos 2\alpha \cos 3\alpha} + \dots + \frac{1}{\cos 9\alpha \cos 10\alpha};$$

$$3) \sin \alpha - \sin 2\alpha + \sin 3\alpha - \dots + (-1)^n \sin n\alpha.$$

**8. Garmonik tebranishlarni qo'shish.** 1)  $y = A \sin(\omega t + \alpha)$  garmonik tebranishni ikki garmonik tebranish yig'indisi ko'rinishida yozishda  $\sin(x + z) = \sin x \cos z + \cos x \sin z$  formuladan foydalanamiz:

$$y = A \sin(\omega t + \alpha) = A \cos \alpha \sin \omega t + A \sin \alpha \cos \omega t,$$

bunga  $C_1 = A \cos \alpha$ ,  $C_2 = A \sin \alpha$  belgilash kiritsak:

$$y = A \sin(\omega t + \alpha) = C_1 \sin \omega t + C_2 \cos \omega t, \quad A = \sqrt{C_1^2 + C_2^2}; \quad (1)$$

2) ikkita garmonik tebranishning  $C_1 \sin \omega t + C_2 \cos \omega t$  yig'indisini  $A \left( \frac{C_1}{A} \sin \omega t + \frac{C_2}{A} \cos \omega t \right)$  ko'rinishda yozib olaylik.  $\left( \frac{C_1}{A} \right)^2 + \left( \frac{C_2}{A} \right)^2 = 1$  bo'lgani uchun  $\frac{C_1}{A} = \cos \alpha$ ,  $\frac{C_2}{A} = \sin \alpha$  tengliklar o'rinli bo'ladigan  $\alpha \in [0; 2\pi]$  son mavjuddir.

Bu yerdan ikkita garmonik tebranishning  $C_1 \sin \omega t + C_2 \cos \omega t$  yig'indisini  $C_1 \sin \omega t + C_2 \cos \omega t = A \sin(\omega t + \alpha)$  ko'rinishda yozish mumkinligi va garmonik tebranishlarning yig'indisi ham garmonik tebranish bo'lishini ko'ramiz;

3) bir xil  $\omega$  chastotali ikki  $C_1 \sin \omega t + C_2 \cos \omega t$  va  $a \sin \omega t + b \cos \omega t$  garmonik tebranish yig'indisi  $(C_1 + a) \sin \omega t + (C_2 + b) \cos \omega t$  bo'ladi, bunda  $\omega$  - yig'indining chastotasi,  $A$  - amplitudasi,  $A = \sqrt{(C_1 + a)^2 + (C_2 + b)^2}$ .

Yig'indining amplitudasi va boshlang'ich fazasini qo'shiluvchi tebranishlar amplitudalari va boshlang'ich fazalari orqali ifodalaylik:

$C_1 = A_1 \cos \alpha_1$ ,  $C_2 = A_2 \cos \alpha_2$ ,  $a = A_2 \cos \alpha_2$ ,  $b = A_2 \sin \alpha_2$  bo'lsin. U holda:

$$\begin{aligned} A^2 &= (C_1 + a)^2 + (C_2 + b)^2 = (A_1 \cos \alpha_1 + A_2 \cos \alpha_2)^2 + \\ &+ (A_1 \sin \alpha_1 + A_2 \sin \alpha_2)^2 = A_1^2 \cos^2 \alpha_1 + 2A_1 A_2 \cos \alpha_1 \cos \alpha_2 + \\ &+ A_2^2 \cos^2 \alpha_2 + A_1^2 \sin^2 \alpha_1 + 2A_1 A_2 \sin \alpha_1 \sin \alpha_2 + A_2^2 \sin^2 \alpha_2 = \\ &= A_1^2 + 2A_1 A_2 \cos(\alpha_1 - \alpha_2) + A_2^2 \end{aligned} \quad (2)$$

Yig'indi tebranishning  $\alpha$  boshlang'ich fazasi quyidagi tengliklardan biri bo'yicha topiladi:

$$\cos \alpha = \frac{C_1 + a}{A} = \frac{1}{A} (A_1 \cos \alpha_1 + A_2 \cos \alpha_2), \quad (3)$$

$$\sin \alpha = \frac{C_2 + b}{A} = \frac{1}{A} (A_1 \sin \alpha_1 + A_2 \sin \alpha_2), \quad (4)$$

$$\operatorname{tg} \alpha = \frac{A_1 \sin \alpha_1 + A_2 \sin \alpha_2}{A_1 \cos \alpha_1 + A_2 \cos \alpha_2}. \quad (5)$$

Har xil chastotali garmonik tebranishlarni qo'shish masalalari oliy matematika kurslarida qaraladi.

**Misol.**  $y = 5 \sin 9x + \sqrt{75} \cos 9x$  funksiyaning eng katta va eng kichik qiymatlarini toping.

**Yechish.** Funksiyani  $y = A \sin(\omega t + \alpha)$  ko'rinishda tasvirlaymiz:

$$\begin{aligned} y &= \sqrt{5^2 + (\sqrt{75})^2} \cdot \left( \frac{5}{\sqrt{5^2 + (\sqrt{75})^2}} \sin 9x + \frac{\sqrt{75}}{\sqrt{5^2 + (\sqrt{75})^2}} \cos 9x \right) = \\ &= 10 \cdot \left( \frac{1}{2} \sin 9x + \frac{\sqrt{3}}{2} \cos 9x \right) = 10 \sin \left( 9x + \frac{\pi}{3} \right). \end{aligned}$$

Bu yerdan,  $-10 \leq 10 \sin \left( 9x + \frac{\pi}{3} \right) \leq 10$  tengsizlikka ega bo'lamiz.

$y \left( \frac{7\pi}{27} \right) = -10$ ,  $y \left( \frac{\pi}{54} \right) = 10$  tengliklar o'rinli va barcha  $x \in R$  larda  $-10 \leq y(x) \leq 10$  bo'lgani uchun  $y(x)$  funksiyaning eng kichik qiymati  $-10$  ga, eng katta qiymati esa  $10$  ga teng bo'ladi.



## Mashqlar

**1.111.** Ifodalarni  $A \sin(\omega t + \alpha)$  ko'rinishga keltiring:

1)  $3 \sin 5t + 4 \cos 5t$ ;                      2)  $11 \sin \left( 3t - \frac{\pi}{6} \right) + \sqrt{23} \cos \left( 3t - \frac{\pi}{6} \right)$ ;

3)  $12 \sin \left( 2t + \frac{\pi}{3} \right) + 5 \cos \left( 2t + \frac{\pi}{3} \right)$ .

**1.112.** Quyida berilgan funksiyalarning eng katta va eng kichik qiymatlarini toping:

1)  $60 \sin 3x - 11 \cos 3x$ ;                      2)  $-12 \sin 4x + 5 \cos 4x$ ;

3)  $2 \sin x + \sqrt{5} \cos x$ ;                      4)  $4 \sin \left( 3x - \frac{\pi}{4} \right) - 3 \cos \left( 3x - \frac{\pi}{4} \right)$ .

**1.113.** Garmonik tebranishlar yig'indisini toping:

1)  $y = 4 \sin 3t$  va  $y = 5 \sin \left( 3t - \frac{\pi}{3} \right)$ ;

2)  $y = 6 \sin \left( 2t + \frac{\pi}{4} \right)$  va  $y = \sin \left( 2t - \frac{\pi}{4} \right)$ ;

$$3) y = 2 \sin\left(5t - \frac{\pi}{3}\right) \quad \text{va}$$

$$y = 5 \sin\left(5t + \frac{\pi}{3}\right);$$

$$4) y = 3 \sin 6t \quad \text{va} \quad y = 2 \sin\left(6t - \frac{\pi}{6}\right).$$

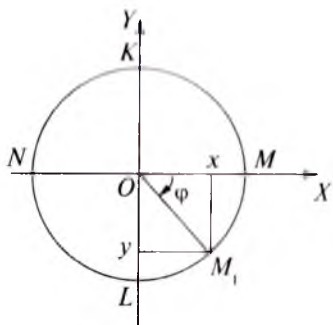

I.38-rasm.

**1.114.** O'zgaruvchan tok tarmo-g'ida  $I$  tok kuchi va  $t$  vaqt orasidagi bog'lanish  $I = I_m \sin(\omega t + \varphi)$  orqali beriladi, bunda  $I_m$  – tok kuchining amplitudaviy qiymati,  $\omega$  – tebranishning doimiy chastotasi,  $\varphi$  –

tok kuchi bilan kuchlanishning fazaviy farqi. Agar  $I_m = 3$ ,  $\omega = 600$ ,  $\varphi = 1,2$  bo'lsa, boshlang'ich fazadagi tok kuchining maksimal qiymatini va sekundiga davrlar sonini toping.

**1.115.** Boshlang'ich  $t_0$  vaqt momentida  $R = |OM|$  radiusli aylanadagi  $M$  nuqta o'zi turgan qism aylana bo'ylab  $\omega$  burchak tezlik bilan harakat qilmoqda (I.38-rasm). U  $t$  vaqtda  $\varphi = \angle MOM_1$  burchakka burilgan,  $\varphi = \omega t$  va  $M_1(x; y)$  nuqtaga yetgan. Harakat davomida  $OX$  o'qidagi  $x$  nuqta  $MN$  diametr bo'yicha,  $OY$  o'qidagi  $y$  nuqta  $KL$  diametr bo'yicha borib-qaytadi va bu harakat garmonik tebranish qonuniyati bo'yicha o'tadi.

1) Koordinatalari shakli o'zgaruvchan to'g'ri burchakli uch-burchak  $OxM_1$  ning katetlari ekanidan foydalanib,  $x$  va  $y$  nuqtalarning garmonik tebranishlari tenglamalarini tuzing;

2) bunday tenglamalarni  $\varphi_0 \neq 0$  va burilish burchagi  $\varphi + \varphi_0$  ga teng bo'lgan hol uchun ham tuzing;

3)  $R = 10$  sm,  $\varphi_0 = 0$ ,  $\varphi = 30^\circ$ ;  $60^\circ$ ;  $90^\circ$ ;  $180^\circ$ ;  $270^\circ$ ;  $450^\circ$  da jism qanchaga siljiydi?

4)  $\omega = 2\pi/T$  va  $t = 10$  s bo'lsa, bir to'liq tebranish uchun ketadigan  $T$  vaqtni hisoblang,  $\varphi$  ning qiymatlarini 3- savoldan oling.

## 4- §. Trigonometrik tenglamalar

### va tengsizliklar

Noma'lum son faqat trigonometrik funksiyalarning argumenti sifatida qatnashgan tenglama (tengsizlik) *trigonometrik tenglama* (*trigonometrik tengsizlik*) deyiladi.

$\sin \alpha = m$ ,  $\cos \alpha = m$ ,  $\operatorname{tg} \alpha = m$ ,  $\operatorname{ctg} \alpha = m$  ko'rinishdagi tenglamalar *eng sodda trigonometrik tenglamalardir*. Bu tenglamalarda tenglik belgisi tengsizlik belgisi bilan almashtirilsa, *eng sodda trigonometrik tengsizliklar* hosil bo'ladi.

Odatda trigonometrik tenglamalarni (tengsizliklarni) yechish bitta yoki bir nechta eng sodda trigonometrik tenglamalarni (tengsizliklarni) yechishga keltiriladi.

**1.  $\sin \alpha = m$  ko'rinishdagi eng sodda tenglama. Arksinus.**  $\sin \alpha = m$  tenglamani yechish birlik aylanadagi shunday  $B(\alpha)$  nuqtani topishdan iboratki, uning  $y = \sin \alpha$  ordinatasi  $m$  ga teng bo'lishi kerak. Buning uchun gorizontal diametrga parallel bo'lgan  $y = m$  to'g'ri chiziq bilan birlik aylananing kesishish nuqtalarini topish kerak. Uch hol bo'lishi mumkin:

a) agar  $|m| > 1$  bo'lsa,  $y = m$  to'g'ri chiziq aylanani kesmay, undan yuqori yoki quyidan o'tadi (I.39-a rasm). Demak, bu holda tenglama yechimga ega emas;

b) agar  $|m| = 1$  bo'lsa, to'g'ri chiziq aylanaga yo yuqoridagi  $B_1\left(\frac{\pi}{2}\right)$  nuqtada yoki quyidagi  $B_2\left(-\frac{\pi}{2}\right)$  nuqtada urinib o'tadi (I.39-b rasm). Bu holda tenglama yagona ildizga ega:  $\alpha = \frac{\pi}{2}$  yoki  $\alpha = -\frac{\pi}{2}$ . Agar funksiyaning  $T = 2\pi$  asosiy davri ham e'tiborga olinsa, yechimni  $\alpha = \frac{\pi}{2} + 2\pi k$ ,  $k \in Z$  ( $\alpha = -\frac{\pi}{2} + 2\pi k$ ,  $k \in Z$ ) ko'rinishda yozish mumkin;

d)  $|m| < 1$  bo'lsa,  $y = m$  to'g'ri chiziq aylanani  $B_1(\alpha_0)$  va  $B_2(\pi - \alpha_0)$  nuqtalarda kesadi (I.39-d rasm). Demak, tenglamaning yechimi shu nuqtalarning koordinatalari bo'lgan barcha sonlar to'plamlarining birlashmasi bo'ladi:

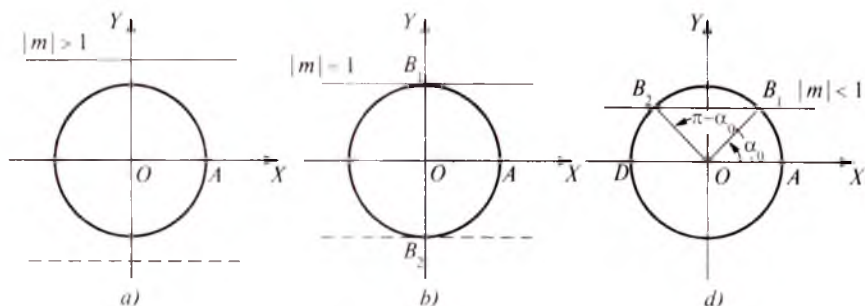

I.39-rasm.

$$\{\alpha_0 + 2k\pi, k \in \mathbb{Z}\} \cup \{\pi - \alpha_0 + 2k\pi, k \in \mathbb{Z}\}.$$

Yechimni  $x = \alpha_0 + 2k\pi, k \in \mathbb{Z}; x = \pi - \alpha_0 + 2k\pi, k \in \mathbb{Z}$  ko'rinishda ham yozish mumkin.

Yechimning geometrik tahlilida  $y = m$  to'g'ri chiziq bilan sinusoidaning kesishish nuqtasi haqida ham gapirilishi mumkin.

1 - misol.  $\sin \alpha = \frac{\sqrt{3}}{2}$  tenglamani yechamiz.

Yechish.  $y = \frac{\sqrt{3}}{2}$  ( $y < 1$ ) to'g'ri chiziq koordinatali aylanani  $B_1\left(\frac{\pi}{3}\right)$  va  $B_2\left(\frac{2\pi}{3}\right)$  nuqtalarda kesadi (I.39-d rasm).  $B_1$  nuqta barcha  $\frac{\pi}{3} + 2k\pi, k \in \mathbb{Z}$  sonlar to'plamiga,  $B_2$  nuqta esa barcha  $\frac{2\pi}{3} + 2k\pi, k \in \mathbb{Z}$  ko'rinishdagi sonlar to'plamiga mos. Barcha yechimlar to'plamini  $\alpha = \frac{\pi}{3} + 2k\pi, k \in \mathbb{Z}; \alpha = \frac{2\pi}{3} + 2k\pi, k \in \mathbb{Z}$  yoki  $\left\{\frac{\pi}{3} + 2k\pi, k \in \mathbb{Z}\right\} \cup \left\{\frac{2\pi}{3} + 2k\pi, k \in \mathbb{Z}\right\}$  ko'rinishda yozish mumkin.

2 - misol. a)  $\sin \alpha = 1$ ; b)  $\sin \alpha = -1$ ; d)  $\sin \alpha = 0$  tenglamalarni yechamiz.

Yechish. a) Koordinatali aylanada faqat bitta  $B_1\left(\frac{\pi}{2}\right)$  nuqtaning ordinatasi 1 ga teng (I.39-b rasm). Yechim:  $\alpha = \frac{\pi}{2} + 2\pi k, k \in \mathbb{Z};$

b)  $B_2\left(-\frac{\pi}{2}\right) = B_2(0; -1)$  nuqta bo'yicha  $\alpha = -\frac{\pi}{2} + 2\pi k, k \in \mathbb{Z};$

d) ordinatasi 0 bo'lgan nuqta ikkita:  $A(0)$  va  $D(\pi)$  (I.39-d rasm).  $A$  nuqtaga  $2k\pi, k \in \mathbb{Z}$ ,  $D$  nuqtaga esa  $\pi + 2k\pi, k \in \mathbb{Z}$  sonlar mos keladi.

Javob:  $\alpha = 2k\pi, k \in \mathbb{Z}; \alpha = \pi + 2k\pi, k \in \mathbb{Z}.$

$|m| \leq 1$  da  $y = m$  to'g'ri chiziq va o'ng yarim birlik aylana yagona umumiy nuqtaga ega bo'ladi. Shu sababli  $\sin \alpha = m$  ( $|m| \leq 1$ ) tenglama  $\left[-\frac{\pi}{2}; \frac{\pi}{2}\right]$  oraliqqa tegishli bo'lgan yagona  $x_0$  yechimga ega.  $\sin \alpha = m$  tenglamani qanoatlantiruvchi  $\alpha_0 \in \left[-\frac{\pi}{2}; \frac{\pi}{2}\right]$  soni  $m$  sonning *arksinusi* deyiladi va *arcsin m* orqali belgilanadi. Ta'rifga ko'ra



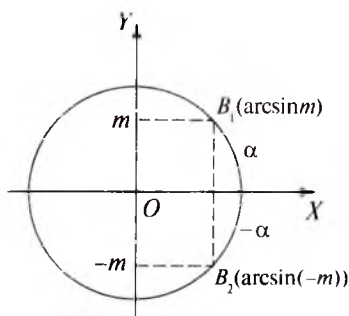

I.40-rasm.

$$\sin(\arcsin m) = m \quad (1)$$

va

$$-\frac{\pi}{2} \leq \arcsin m \leq \frac{\pi}{2} \quad (2)$$

bo'ldi. Aksincha,  $\sin \alpha = m$  va  $-\frac{\pi}{2} \leq \alpha \leq \frac{\pi}{2}$  bo'lsa,  $\alpha = \arcsin m$  bo'ldi.

3-misol. a)  $\arcsin \frac{\sqrt{3}}{2}$ ; b)  $\arcsin(-\frac{1}{2})$ ;  
d)  $\arcsin(-\frac{\sqrt{3}}{2})$  ifodalarni hisoblaymiz.

**Yechish.** a)  $\sin x = \frac{\sqrt{3}}{2}$  bo'yicha  $x_1 = \frac{\pi}{3}$ ,  $x_2 = \frac{2\pi}{3}$ . Arksinusning ta'rifi bo'yicha  $-\frac{\pi}{2} \leq x \leq \frac{\pi}{2}$  bo'lishi kerak. Bu shartga  $x_1 = \frac{\pi}{3}$  to'g'ri keladi. Demak,  $\arcsin \frac{\sqrt{3}}{2} = \frac{\pi}{3}$ .

b)  $\sin(-\frac{\pi}{6}) = -\frac{1}{2}$ ,  $-\frac{\pi}{2} \leq -\frac{\pi}{6} \leq \frac{\pi}{2}$  bo'lgani uchun  $\arcsin(-\frac{1}{2}) = -\frac{\pi}{6}$  bo'ldi.

d)  $\sin(-\frac{\pi}{3}) = -\frac{\sqrt{3}}{2}$ ,  $-\frac{\pi}{2} \leq -\frac{\pi}{3} \leq \frac{\pi}{2}$ . Demak,  $\arcsin(-\frac{\sqrt{3}}{2}) = -\frac{\pi}{3}$ .

I.40-rasmdan  $y = m$  va  $\alpha = \arcsin m$  sonlari orasidagi bog'lanish ayon bo'ldi. Chizmada  $\alpha = \arcsin m$  va  $-\alpha = \arcsin(-m)$ . Demak,

$$\arcsin(-m) = -\arcsin m. \quad (3)$$

Shunday qilib,  $|m| \leq 1$  bo'lgan holda  $\sin \alpha = m$  tenglamaning  $\alpha$  yechimi  $\{\arcsin m + 2k\pi, k \in \mathbb{Z}\} \cup \{\pi - \arcsin m + 2k\pi, k \in \mathbb{Z}\}$  to'plamlar birlashmasi ko'rinishida yoki  $\alpha = \arcsin m + 2k\pi, k \in \mathbb{Z}$ ,  $\alpha = \pi - \arcsin m + 2k\pi, k \in \mathbb{Z}$  ko'rinishda yoki bu keyingi ikki formulani birlashtirib,

$$\alpha = (-1)^k \arcsin m + k\pi, k \in \mathbb{Z} \quad (4)$$

ko'rinishda yozish mumkin.

4-misol. a)  $\sin \alpha = \frac{1}{7}$ ; b)  $\sin \alpha = -\frac{1}{9}$  tenglamalarni yechamiz.

**Yechish.** a)  $\sin \alpha = \frac{1}{7}$  tenglama yechimini (4) formula bo'yicha  $\alpha = (-1)^k \arcsin \frac{1}{7} + k\pi, k \in \mathbb{Z}$  ko'rinishda yozamiz;

b) (3) munosabatga ko'ra  $\arcsin\left(-\frac{1}{9}\right) = \arcsin\frac{1}{9}$ .

Yechim:  $\left\{-\arcsin\frac{1}{9} + 2k\pi, k \in \mathbb{Z}\right\} \cup \left\{\pi + \arcsin\frac{1}{9} + 2k\pi, k \in \mathbb{Z}\right\}$

yoki  $\alpha = (-1)^{k+1} \arcsin\frac{1}{9} + k\pi, k \in \mathbb{Z}$  ekanligi kelib chiqadi.



### Mashqlar

**1.116.** Tenglamalarni yeching va grafik yordamida tushuntiring:

- 1)  $\sin x = -0,5$ ; 2)  $\sin x = -0,75$ ; 3)  $\sin x = 0,2$ ; 4)  $\sin x = \frac{7}{8}$ ;  
 5)  $\sin x = \frac{\sqrt{2}}{2}$ ; 6)  $\sqrt{3} \sin x + \frac{3}{2} = 0$ ; 7)  $5 \sin x - 7 = 0$ ; 8)  $6 \sin x - 2 = 0$ .

**1.117.** Tenglamalarni yeching:

- 1)  $4 \sin^2 x - 1 = 0$ ; 2)  $-2 \sin^2 x + \sin x + 1 = 0$ ;  
 3)  $3 \sin^2 x - 4 \sin x - 0,75 = 0$ ; 4)  $\sqrt{3} \sin x - 2 \sin^2 x = 0$ .

**1.118.** Qiymatini toping:

- 1)  $\arcsin\left(-\frac{\sqrt{2}}{2}\right)$ ; 2)  $\arcsin\left(\frac{\sqrt{2}}{2}\right)$ ; 3)  $\arcsin 0,5$ .

**1.119.** Hisoblang:

- 1)  $\arcsin(\sin 30^\circ)$ ; 2)  $\arcsin\left(\sin \frac{\pi}{12}\right)$ ;  
 3)  $\arcsin(\sin 2)$ ; 4)  $\arcsin(\sin 10)$ .

**1.120.**  $\arcsin \alpha$  quyidagi qiymatlarni qabul qila oladimi?

- 1)  $\frac{\pi}{3}$ ; 2)  $-3\pi$ ; 3)  $-\frac{\pi}{6}$ ; 4)  $\frac{\pi}{4}$ ; 5)  $-\frac{\pi}{4}$ ; 6)  $\sqrt{3}$ ; 7)  $-\pi$ ;  
 8)  $4\sqrt{5}$ .

**2.  $\cos \alpha = m$  ko'rinishdagi eng sodda tenglama. Arkkosinus.**

Koordinatali aylana olingan har qaysi  $B(\alpha)$  nuqtaning

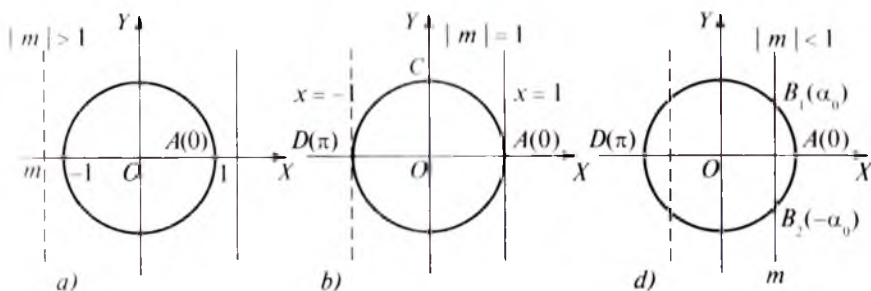

1.41-rasm.

abssissasi  $x = \cos \alpha$  ga teng. Shunga ko'ra berilgan  $m$  bo'yicha  $\cos \alpha = m$  tenglamani yechish nuqtaning  $x = m$  abssissasi bo'yicha unga mos  $\alpha = \alpha_0$  yoy kattaligini topishdan iborat. Uch holni qaraymiz:

1 - hol.  $|m| > 1$  da  $x = m$  vertikal to'g'ri chiziq aylanani kesmaydi (I.41-a rasm). Bu holda tenglama yechimga ega emas. Masalan,  $\cos \alpha = 2,8$  tenglama yechimga ega emas, chunki  $m = 2,8 > 1$ .

2 - hol. Agar  $|m| = 1$  bo'lsa, to'g'ri chiziq aylanani faqat bir nuqtada, ya'ni yo  $A(1; 0)$  nuqtada, yoki  $D(-1; 0)$  nuqtada kesadi (I.41-b rasm).  $A$  nuqtaning aylana bo'yicha koordinatasi  $\alpha = 2\pi k$ ,  $k \in \mathbb{Z}$ . Shunga ko'ra  $\cos \alpha = 1$  ning yechimi  $\alpha = 2\pi k$ ,  $k \in \mathbb{Z}$  sonlar to'plami bo'ladi.  $D(-1; 0) = D(\pi + 2\pi k)$  ekani e'tiborga olinsa,  $\cos \alpha = -1$  ning yechimi  $\alpha = \pi + 2\pi k$  sonlar to'plami bo'ladi.

3 - hol.  $|m| < 1$  bo'lsa,  $x = m$  to'g'ri chiziq aylanani ikki nuqtada kesadi (I.41-d rasm). Ulardan biri  $B_1(\alpha_0)$  nuqta  $0 \leq \alpha_0 \leq \pi$  yuqori yarim aylanada joylashadi.  $\alpha_0$  son  $m$  sonning *arkkosinusi* deyiladi va  $\alpha_0 = \arccos m$  orqali belgilanadi. Ta'rifga ko'ra  $\cos \alpha = \cos(\arccos m) = m$  va  $0 \leq \arccos m \leq \pi$  bo'ladi.

Shu kabi  $B_2(-\alpha_0)$  nuqta uchun:  $\cos(-\alpha_0) = \cos \alpha_0 = m$ . Bundan  $-\alpha_0 = \arccos m$  yoki  $\alpha_0 = -\arccos m$ . Demak,  $|m| < 1$ ,  $k \in \mathbb{Z}$  da  $\cos \alpha = m$  tenglamaning yechimi  $\{\arccos m + 2\pi k, k \in \mathbb{Z}\} \cup \{-\arccos m + 2\pi k, k \in \mathbb{Z}\}$  sonlar to'plamlari birlashmasi bo'ladi. Uni

$$\{\pm \arccos m + 2\pi k, k \in \mathbb{Z}\} \quad (1)$$

yoki

$$\pm \arccos m + 2\pi k, k \in \mathbb{Z} \quad (2)$$

ko'rinishda ham yozish mumkin. I.42-rasmdan,  $OY$  o'qiga nisbatan simmetrik joylashgan  $B_1(\arccos m) = B_1(\alpha)$  va  $B_2(\arccos(-m)) = B_2(\pi - \alpha)$  nuqtalar bo'yicha  $\alpha = \arccos m$  va  $\pi - \alpha = \arccos(-m)$  bo'lishini aniqlaymiz. Undan:

$$\arccos(-m) = \pi - \arccos m \quad (3)$$

hosil qilinadi, bunda  $0 \leq \alpha \leq \pi$ .

1 - misol.  $\cos \alpha = \frac{\sqrt{3}}{2}$  tenglamani yechamiz.

**Yechish.**  $\cos \frac{\pi}{6} = \cos\left(-\frac{\pi}{6}\right) = \frac{\sqrt{3}}{2}$  bo'ladi. Demak,  $x = \frac{\sqrt{3}}{2}$  to'g'ri chiziq koordinatali aylanani  $B_1\left(\arccos \frac{\sqrt{3}}{2}\right) = B_1\left(\frac{\pi}{6}\right)$  nuqtada va abssissalar o'qiga nisbatan  $B_1$  ga simmetrik joylashgan

$B_2\left(-\arccos\frac{\sqrt{3}}{2}\right) = B_2\left(-\frac{\pi}{6}\right)$  nuqtada ke-sadi. Yechim  $B_1$  nuqta bo'yicha  $\frac{\pi}{6} + 2\pi k, k \in Z$  sonlar to'plami va  $B_2$  nuqta bo'yicha  $-\frac{\pi}{6} + 2\pi k, k \in Z$  sonlar to'plami birlashmasi bo'ladi:

$$\cos \alpha = \frac{\sqrt{3}}{2}; \left\{ \frac{\pi}{6} + 2k\pi, k \in Z \right\} \cup$$

$$\cup \left\{ -\frac{\pi}{6} + 2k\pi, k \in Z \right\} \text{ yoki}$$

$$\alpha = \pm \frac{\pi}{6} + 2k\pi, k \in Z.$$

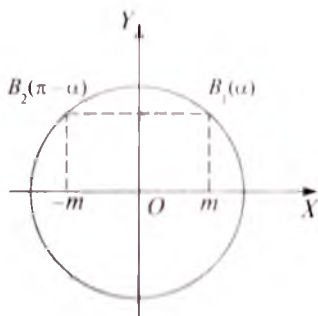

1.42-rasm.

2-misol.  $\arccos\left(-\frac{1}{2}\right)$  ni hisoblang.

Yechish. (3) formulaga ko'ra, quyidagini topamiz:

$$\arccos\left(-\frac{1}{2}\right) = \pi - \arccos\frac{1}{2} = \pi - \frac{\pi}{3} = \frac{2\pi}{3}.$$

3-misol.  $\cos x = -\frac{3}{7}$  tenglamani yeching.

Yechish.  $x = \pm \arccos\left(-\frac{3}{7}\right) + 2\pi k, k \in Z$  ga egamiz. (3) ga ko'ra  $x = \pm\left(\pi - \arccos\frac{3}{7}\right) + 2\pi k, k \in Z$  bo'ladi.

4-misol.  $\cos x = \frac{1}{3}$  tenglamani  $y = \cos x$  funksiya grafigi yordamida yeching.

Yechish. Ayni bir XOY koordinatalar sistemasida  $y = \cos x$  va  $y = \frac{1}{3}$  funksiyalar grafiklarini yasaymiz (1.43-rasm).

Bu grafiklar cheksiz ko'p nuqtalarda kesishadi.  $y = \cos x$  funksiya davri  $2\pi$  bo'lgan davriy funksiya bo'lgani uchun berilgan

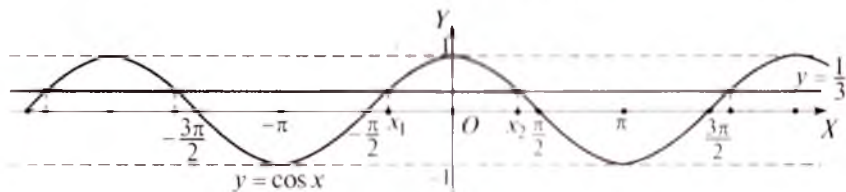

1.43-rasm.

tenglamaning  $[-\pi; \pi]$  kesmadagi barcha yechimlarini topish va qolgan yechimlarni shu yechimlar orqali aniqlash mumkin.

$[-\pi; \pi]$  oraliqda  $y = \cos x$  funksiya grafigi  $y = \frac{1}{3}$  funksiya grafigi bilan ikkita kesishish nuqtasiga ega. Kesishish nuqtalarining  $x_1 = -\arccos \frac{1}{3}$ ,  $x_2 = \arccos \frac{1}{3}$  absissalari berilgan tenglamaning  $[-\pi; \pi]$  dagi barcha yechimlaridir. Shu sababli barcha yechimlar quyidagicha aniqlanadi:  $x = \pm \arccos \frac{1}{3} + 2\pi k$ ,  $k \in Z$ .

5-misol.  $\arccos(\cos 53^\circ)$  ni toping.

Yechish.  $\arccos(\cos m) = m$ , ( $0 \leq m \leq \pi$ ) ayniyatdan foydalanamiz.  $53^\circ = \frac{53\pi}{180}$  va  $0 < \frac{53\pi}{180} < \pi$  bo'lgani uchun bu ayniyatga ko'ra

$$\arccos(\cos 53^\circ) = \arccos\left(\cos \frac{53\pi}{180}\right) = \frac{53\pi}{180}.$$



## Mashqlar

**1.121.** Tenglamani  $y = \cos x$  funksiya grafigi yordamida yeching:

- 1)  $\cos x = 0$ ;                      2)  $\cos x = 0,5$ ;                      3)  $\cos x = -\frac{2}{9}$ ;  
 4)  $\cos x = -\frac{\sqrt{2}}{2}$ ;                      5)  $\cos x = 2,4$ ;                      6)  $2 \cos x + \sqrt{3} = 0$ .

**1.122.** Ifodaning qiymatini toping:

- 1)  $\arccos\left(-\frac{\sqrt{2}}{2}\right)$ ; 2)  $\arccos(-0,5)$ ; 3)  $\arccos(\cos 30^\circ)$ ;  
 4)  $\arccos(\cos(-30^\circ))$ ; 5)  $\arccos(\sin 30^\circ)$ ; 6)  $\arccos(\cos 2)$ ;  
 7)  $\arccos(\cos(-2))$ ; 8)  $\arccos(\sin 2)$ ; 9)  $\arccos(\sin(-2))$ ;  
 10)  $\arccos(\cos 88)$ ; 11)  $\arccos(\sin 86)$ .

**1.123.** Tengliklarning to'g'riligini tekshiring:

- 1)  $\arccos x = -\arcsin x$ ;                      2)  $-\arccos x = \pi + \arccos x$ .

**1.124.** Ifodaning qiymatini toping:

- 1)  $\cos\left(\arccos \frac{\sqrt{3}}{2} - \arcsin \frac{\sqrt{3}}{2}\right)$ ; 2)  $\sin\left(\arccos \frac{1}{2} + \arcsin \frac{\sqrt{3}}{2}\right)$ .

**1.125.** Tenglamani yeching:

- 1)  $\cos^2 x - 3 = 0$ ;                      2)  $\cos 2x = \left(-\frac{\sqrt{2}}{2}\right)$ ;                      3)  $6\cos^2 x + 3 = 0$ ;  
 4)  $3\cos^2 x - 5 = 0$ ;                      5)  $2\cos^2 x - 1 = 0$ ;                      6)  $4\cos^2 x - 1 = 0$ .

1.126. Tenglamani yeching:

1)  $\cos^2 x - 2\cos x = 0$ ;

2)  $2\cos^2 x - \cos x = 0$ ;

3)  $2\cos^2 x - \cos x - 1 = 0$ ;

4)  $2\cos^2 x - 3\cos x + 1 = 0$ .

3.  $\operatorname{tg}\alpha = m$  va  $\operatorname{ctg}\alpha = m$  ko'rinishdagi eng sodda tenglamalar.

**Arktangens va arkkotangens.** Koordinatali aylananing har bir  $B(\alpha)$  nuqtasi Dekart koordinatalar sistemasidagi biror  $B(x, y)$  nuqta bilan ustma-ust tushishini va  $x = \cos\alpha$ ,  $y = \sin\alpha$  ekanini bilamiz. Shunga ko'ra, noma'lum  $\alpha$  qatnashayotgan  $\operatorname{tg}\alpha = m$  yoki  $\frac{\sin\alpha}{\cos\alpha} = m$  tenglamaning barcha yechimlarini koordinatali aylana

bilan  $\frac{y}{x} = m$ , ya'ni  $y = mx$  to'g'ri chiziqning kesishish nuqtalari yordamida aniqlash mumkin.  $m$  ning har qanday qiymatida  $y = mx$  to'g'ri chiziq aylananing  $O(0; 0)$  nuqtasiga nisbatan simmetrik bo'lgan  $B_1$  va  $B_2$  nuqtalarda kesadi (I.44-rasm). Ulardan

biri  $-\frac{\pi}{2} < \alpha < \frac{\pi}{2}$  o'ng yarim aylana yotadi. Bu nuqta  $B_1(\alpha_0)$

bo'lsin. Ikkinchi nuqta  $B_2(\alpha_0 + \pi)$  bo'ladi. Demak,  $\operatorname{tg}\alpha = m$  tenglamaning barcha yechimlari to'plami  $\alpha = \alpha_0 + 2k\pi$ ,  $k \in \mathbb{Z}$  va  $\alpha = -(\alpha_0 + \pi) + 2k\pi$ ,  $k \in \mathbb{Z}$  sonlar to'plamlari birlashmasidan iborat. Barcha yechimlar

$$\alpha = \alpha_0 + k\pi, k \in \mathbb{Z} \quad (1)$$

formula bilan aniqlanadi.

$m$  sonning *arktangensi* deb  $(-\frac{\pi}{2}; \frac{\pi}{2})$  oraliqda yotadigan shunday  $\alpha$  songa aytiladiki, uning uchun  $\operatorname{tg}\alpha = m$  bo'ladi.  $m$  sonning arktangensi  $\alpha = \operatorname{arctg}m$  orqali belgilanadi. Ta'rifga asosan, har qanday  $m$  son uchun quyidagi munosabatlar o'rinli bo'ladi:

$$\operatorname{tg}(\operatorname{arctg}m) = m, \quad -\frac{\pi}{2} < \operatorname{arctg}m < \frac{\pi}{2}. \quad (2)$$

Aksincha,  $\operatorname{tg}\alpha = m$ ,  $-\frac{\pi}{2} < \alpha < \frac{\pi}{2}$  bo'lsa,  $\alpha = \operatorname{arctg}m$  bo'ladi.

Yuqoridagi shartlardan va tangens toq funksiyaligidan  $\operatorname{tg}(-\alpha) = -\operatorname{tg}\alpha = -m$  bo'lgani uchun quyidagi tenglik o'rinli bo'ladi:

$$\operatorname{arctg}(-m) = -\operatorname{arctg}m \quad (3)$$

Arkkotangens tushunchasi ham shu kabi kiritiladi.

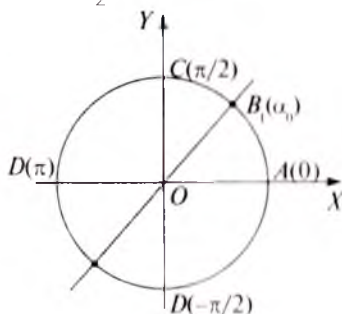

I.44-rasm.

$m$  sonning arkkotangensi deb  $(0; \pi)$  oraliqda yotadigan shunday  $\alpha$  songa aytiladiki, uning uchun  $\text{ctg}\alpha = m$  bo'ladi.  $m$  sonning arkkotangensi  $\alpha = \text{arctg}m$  orqali belgilanadi. Uning uchun quyidagi tenglik o'rinni:

$$\text{arctg}(-m) = \pi - \text{arctg}m. \quad (4)$$

1 - misol. a)  $\text{tg}x = -\sqrt{3}$ ; b)  $\text{ctg}x = -\sqrt{3}$  tenglamalarni yechamiz.

Yechish. a)  $\text{tg}\left(-\frac{\pi}{3}\right) = -\sqrt{3}$ , demak,  $x = -\frac{\pi}{3} + \pi k, k \in Z$ .

b)  $\text{ctg}\frac{5\pi}{6} = -\sqrt{3}$ , demak,  $x = \frac{5\pi}{6} + \pi k, k \in Z$ .

2 - misol. a)  $\text{arctg}(-\sqrt{3})$ ; b)  $\text{arctg}(-\sqrt{3})$  sonlarni topamiz.

Yechish. a) (3) formula bo'yicha  $\text{arctg}(-\sqrt{3}) = -\text{arctg}\sqrt{3} = -\frac{\pi}{3}$ ;

b) (4) formula bo'yicha  $\text{arctg}(-\sqrt{3}) = \pi - \frac{\pi}{6} = \frac{5\pi}{6}$ .



## Mashqlar

**1.127.** Tenglamani yeching (grafikdan ham foydalaning):

1)  $\text{tg}x = -\frac{\sqrt{3}}{2}$ ;      2)  $\text{ctg}x = -\sqrt{3}$ ;      3)  $\text{ctg}x = 0,2$ .

**1.128.** Ifodaning qiymatini toping:

1)  $\text{arctg}\left(-\frac{\sqrt{3}}{2}\right)$ ;    2)  $\text{arctg}1$ ;    3)  $\text{arctg}(-1)$ ;    4)  $\text{arctg}0$ ;  
5)  $\text{arctg}0$ .

**1.129.** Hisoblang:

1)  $\text{tg}\left(\arcsin\frac{\sqrt{3}}{2}\right)$ ;      2)  $\text{ctg}(\arcsin 0,5)$ ;  
3)  $\text{tg}(\arccos 0,5)$ ;      4)  $\text{ctg}(\text{arctg}(-1))$ ;  
5)  $\text{tg}\left(\text{arctg}\left(-\frac{2}{3}\right)\right)$ ;      6)  $\sin\left(\text{arctg}(\sqrt{3})\right)$ ;  
7)  $\cos\left(\text{arctg}\left(-\frac{\sqrt{3}}{3}\right)\right)$ ;      8)  $\cos(\text{arctg}(-0,8))$ .

**1.130.**  $\text{arctg}x = \frac{\pi}{2} - \text{arctg}x$  tenglikning to'g'riligini tekshiring.

1.131. Hisoblang:

$$1) \sin\left(\operatorname{arctg} \frac{\sqrt{3}}{2} - \operatorname{arctg} \frac{\sqrt{3}}{2}\right); \quad 2) \operatorname{tg}\left(\arcsin \frac{\sqrt{2}}{2} - \operatorname{arctg} \sqrt{3}\right).$$

1.132.  $\operatorname{arctg} x$  quyidagi qiymatlarni qabul qila oladimi?  $\operatorname{arctg} x$ -chi:

$$1) 0; \quad 2) -0,01; \quad 3) -\pi; \quad 4) \pi/2;$$

$$5) 3\pi/2; \quad 6) \sqrt{2}; \quad 7) -1; \quad 8) \pi?$$

**4. Tenglamalarni yechishning asosiy usullari.** Trigonometrik tenglama noma'lum argumentning trigonometrik funksiyalariga nisbatan

$$R(z) = a_0 z^n + a_1 z^{n-1} + \dots + a_{n-1} z + a_n = 0 \quad (1)$$

ko'rinishdagi algebraik tenglamaga keltirilishi mumkin, bunda  $z$  orqali  $\sin \lambda x$ ,  $\cos \lambda x$ ,  $\operatorname{tg} \lambda x$ ,  $\operatorname{ctg} \lambda x$  funksiyalardan biri ifodalangan. Algebraik tenglama kabi (1) trigonometrik tenglamalarni yechishda yangi noma'lum kiritish, ko'paytuvchilarga ajratish va hokazo usullar qo'llaniladi. Jarayon eng sodda trigonometrik tenglamalardan birini yechishgacha boradi. Trigonometrik tenglamalarni yechishda asosan quyidagi hollar uchraydi:

1)  $R(f(x)) = 0$  tenglamada  $R$  trigonometrik funksiya belgisi ostida  $x$  ga bog'liq bo'lgan  $f(x)$  ifoda turibdi.  $f(x) = z$  almashtirish orqali tenglama eng sodda  $R(z) = 0$  trigonometrik tenglamalardan biriga keltirilishi mumkin. Uning  $z = z_i$  ildizlari birma-bir  $f(x) = z$  ga qo'yiladi va  $x$  ning qiymatlari topiladi.

1 - misol.  $\sin\left(10x + \frac{\pi}{8}\right) = \frac{\sqrt{3}}{2}$  tenglamani yechamiz.

**Yechish.** Misolimizda  $f(x) = 10x + \frac{\pi}{8}$ . Tenglamaga

$10x + \frac{\pi}{8} = z$  almashtirish kiritib,  $\sin z = \frac{\sqrt{3}}{2}$  tenglama hosil

bo'ladi. Uning yechimi:  $z = (-1)^k \frac{\pi}{3} + k\pi$ ,  $k \in \mathbb{Z}$ . Bu  $10x + \frac{\pi}{8} = z$  ga qo'yiladi va javob topiladi:

$$x = \frac{1}{10} \left( -\frac{\pi}{8} + (-1)^k \frac{\pi}{3} + k\pi \right), \quad k \in \mathbb{Z}.$$

2 - misol.  $\operatorname{tg}\left(x^2 + 6x + \frac{\pi}{6}\right) = \frac{\sqrt{3}}{3}$  tenglamani yechamiz.

**Yechish.**  $z = x^2 + 6x + \frac{\pi}{6}$  almashtirish kiritamiz. Tenglama

$\operatorname{tg} z = \frac{\sqrt{3}}{3}$  ko'rinishga keladi. Undan  $z = \frac{\pi}{6} + k\pi$ ,  $k \in \mathbb{Z}$  ni topamiz.



U holda  $x^2 + 6x + \frac{\pi}{6} = \frac{\pi}{6} + k\pi$ ,  $k \in Z$  yoki  $x^2 + 6x - k\pi = 0$ ,  $k \in Z$ .

Kvadrat tenglamaning ildizlari  $x = -3 \pm \sqrt{9 + k\pi}$ ,  $k \in Z$ , bunda

$9 + k\pi \geq 0$  yoki  $k \geq -\frac{9}{\pi} = -2,86\dots$ , ya'ni  $k = -2; -1; 0; 1; \dots$ .

Javob:  $x = -3 \pm \sqrt{9 + k\pi}$ ,  $k \in Z$ ,  $k \geq -2$ .

2)  $\sin x = \sin \alpha$ ,  $\cos x = \cos \alpha$  va  $\operatorname{tg} x = \operatorname{tg} \alpha$  tenglamalar. Bu tenglamalar mos ravishda  $x = (-1)^k \alpha + k\pi$ ,  $k \in Z$ ,  $x = \pm \alpha + 2n\pi$ ,  $n \in Z$ ,  $x = \alpha + m\pi$ ,  $m \in Z$  formulalar yordamida yechilishi mumkin.

3 - misol.  $\cos(5x - 45^\circ) = \cos(2x + 60^\circ)$  tenglamani yeching.

Yechish.  $5x - 45^\circ = \pm(2x + 60^\circ) + 360^\circ k$ ,  $k \in Z$  tenglamalarni yechamiz.  $5x - 45^\circ = +(2x + 60^\circ) + 360^\circ k$ ,  $k \in Z$  tenglikdan  $x = 35^\circ + 120^\circ k$ ,  $k \in Z$  yechimlar guruhini,  $5x - 45^\circ = -(2x + 60^\circ) + 360^\circ k$ ,  $k \in Z$  tenglikdan esa  $x = \frac{1}{7}(-15^\circ + 360^\circ k)$ ,  $k \in Z$  yechimlar guruhini topamiz.

Shunday qilib,  $x = 35^\circ + 120^\circ k$ ,  $k \in Z$ ;  $x = \frac{1}{7}(-15^\circ + 360^\circ k)$ ,  $k \in Z$ .

4 - misol.  $\sin x^2 = \sin(6x - 5)$  tenglamani yechamiz.

Yechish.  $x^2 = (-1)^k(6x - 5) + k\pi$ ,  $k \in Z$  tenglama hosil bo'ladi.

Agar  $k$  juft bo'lsa, ya'ni  $k = 2n$ ,  $n \in Z$  da  $x^2 = 6x - 5 + 2n\pi$ ,  $n \in Z$  kvadrat tenglama kelib chiqadi. Uning yechimi

$$x_{1,2} = 3 \pm \sqrt{9 - (5 - 2n\pi)}, \quad n \in Z, \quad n \geq \left[-\frac{2}{\pi}\right].$$

Agar  $k$  toq bo'lsa, ya'ni  $k = 2m + 1$ ,  $m \in Z$  da  $x^2 = -6x + 5 + (2m + 1)\pi$ ,  $m \in Z$  ko'rinishda bo'ladi va bundan

$$x_{1,2} = -3 \pm \sqrt{9 + (5 + 2(m + 1)\pi)}, \quad m \in Z, \quad m \geq \left[-\frac{14 + \pi}{2\pi}\right].$$

3)  $f(R(x)) = 0$  tenglamada  $R$  trigonometrik funksiya boshqa  $f$  funksiya belgisi ostida turadi.  $R(x) = z$  almashtirish masalani  $f(z) = 0$  tenglamani yechishga keltiradi. Bu tenglamaning  $z_1, z_2, \dots$  ildizlari bo'yicha  $R(x) = z_1$ ,  $R(x) = z_2, \dots$  tenglamalar majmuasini hosil qilamiz. Uni yechish bilan masala hal qilinadi.

5 - misol.  $\sin^2 x + 3\sin x + 1,25 = 0$  tenglamani yechamiz.

**Yechish.**  $\sin x = z$  almashtirish natijasida  $z^2 + 3z + 1,25 = 0$  kvadrat tenglama hosil bo'ladi. Uning ildizlari  $z_1 = -5$ ,  $z_2 = -1$ .  $\sin x = -5$  tenglama yechimga ega emas.  $\sin x = -1$  tenglama  $x = -90^\circ + 360^\circ k$ ,  $k \in \mathbb{Z}$  yechimlarga ega.

4) Ba'zan berilgan tenglamani *ko'paytuvchilarga ajratish* usulidan trigonometrik funksiyalar yig'indisini ko'paytma ko'rinishiga keltirishda foydalaniladi.

6 - misol.  $2 \cos x - 2 \sin 2x - 2\sqrt{2} \sin x + \sqrt{2} = 0$  tenglamani yechamiz.

**Yechish.**  $\sin 2x = 2 \sin x \cos x$  almashtirish tenglamani  $2 \cos x - 4 \sin x \cos x - 2\sqrt{2} \sin x + \sqrt{2} = 0$  ko'rinishga keltiradi. Uning chap qismini ko'paytuvchilarga ajratamiz:

$$2 \cos x (1 - 2 \sin x) + \sqrt{2} (1 - 2 \sin x) = 0,$$

$$(1 - 2 \sin x)(2 \cos x + \sqrt{2}) = 0,$$

bundan:

$$\begin{cases} 1 - 2 \sin x = 0, \\ 2 \cos x + \sqrt{2} = 0, \end{cases} \Rightarrow \begin{cases} \sin x = 0,5, \\ \cos x = -\frac{\sqrt{2}}{2}. \end{cases}$$

$$\text{Javob: } \{(-1)^k 30^\circ + 180^\circ k, k \in \mathbb{Z}\} \cup \{\pm 135^\circ + 360^\circ k, k \in \mathbb{Z}\}.$$

7 - misol.  $\sqrt{1 + \frac{1}{2} \sin x} = \cos x$  tenglamani yeching.

**Yechish.** Bu tenglama  $\begin{cases} \cos x \geq 0, \\ 1 + \frac{1}{2} \sin x = \cos^2 x \end{cases}$  yoki

$\begin{cases} \cos x \geq 0, \\ \sin x \left( \sin x + \frac{1}{2} \right) = 0 \end{cases}$  tenglamalar sistemasiga teng kuchlidir (VI

bob, 7-§; 1-band).  $\begin{cases} \cos x \geq 0, \\ \sin x \left( \sin x + \frac{1}{2} \right) = 0, \end{cases} \Rightarrow \begin{cases} \cos x \geq 0, \\ \sin x = 0; \\ \cos x \geq 0, \\ \sin x = -\frac{1}{2} \end{cases}$  bo'lgani

uchun berilgan tenglamaning barcha yechimlari  $x = 2k\pi$ ,  $k \in \mathbb{Z}$  va  $x = -\frac{\pi}{6} + 2k\pi$ ,  $k \in \mathbb{Z}$  formulalar bilan aniqlanadi.

J a v o b:  $\{2k\pi, k \in \mathbb{Z}\} \cup \{-\frac{\pi}{6} + 2k\pi, k \in \mathbb{Z}\}$ .



## M a s h q l a r

**1.133.** Tenglamani yeching:

1)  $\sin 10x = -\frac{\sqrt{3}}{2}$ ;

2)  $\cos 10x = \frac{\sqrt{3}}{2}$ ;

3)  $\operatorname{tg} 10x = \sqrt{3}$ ;

4)  $\operatorname{ctg} 10x = \frac{\sqrt{3}}{3}$ ;

5)  $\sin(6x - 60^\circ) = -1$ ;

6)  $\cos(4x + 30^\circ) = 0$ ;

7)  $\operatorname{tg}(5x - 45^\circ) = 0$ ;

8)  $\sin^2 \frac{3}{x} = \frac{3}{4}$ ;

9)  $\cos^2(2x - 45^\circ) = \frac{1}{4}$ ;

10)  $\operatorname{tg}^2\left(6x - \frac{\pi}{4}\right) = 3$ ;

11)  $\sin^2\left(7x - \frac{\pi}{6}\right) = 3$ ;

12)  $\cos^2\left(4x + \frac{\pi}{3}\right) = -\frac{1}{4}$ ;

13)  $\operatorname{tg}^2\left(5x - \frac{\pi}{3}\right) = -1$ ;

14)  $\sin(4x^2) = 0,5$ ;

15)  $\cos^2 6x^2 = 0,25$ ;

16)  $\operatorname{tg} \frac{5}{x} = -1$ .

**1.134.** Tenglamani yeching:

1)  $\sin 4x \cos 3x \operatorname{tg} 8x = 0$ ;

2)  $\cos 4x = -\cos 5x$ ;

3)  $\operatorname{tg} 5x = -\operatorname{tg} \frac{x}{3}$ ;

4)  $\sin 11x = -\sin 15x$ ;

5)  $\cos 4x = \cos x$ ;

6)  $\operatorname{tg} 3x = -\operatorname{ctg} 5x$ ;

7)  $\sin \frac{x}{3} = \cos \frac{x}{4}$ ;

8)  $\operatorname{tg}(5\pi - x) = -\operatorname{ctg}\left(2x + \frac{\pi}{6}\right)$ ;

9)  $\sin \frac{x}{6} = \sin \frac{4}{x}$ ;

10)  $\sin\left(x^2 - \frac{\pi}{4}\right) = -\cos x^3$ ;

11)  $\operatorname{ctg} 7 = -\operatorname{ctg} \frac{3}{x}$ ;

12)  $\operatorname{ctg} \sqrt{x} = \operatorname{tg} 2x$ ;

13)  $\cos^2 2x + 3\cos 2x + 2 = 0$ ;

14)  $\operatorname{tg}^2 5x - 3\operatorname{tg} 5x - 4 = 0$ ;

15)  $\sin x^2 = -\sin 3x^2$ ;

16)  $\sin^2 x + \sin^2 2x + 2 = 0$ ;

17)  $\sqrt{2}(\cos^3 x + \sin^3 x) = \sin 2x$ .

**5. Xususiy usullar.** 1) Agar tenglama tarkibida har xil trigonometrik funksiyalar qatnashsa, ularni bir ismli funksiyaga keltirish, so'ngra almashtirishlarni bajarish kerak.

1 - m i s o l .  $3\sin^2x + 4\sin x + 2\cos^2x - 7 = 0$  tenglamani yechamiz.

Y e c h i s h .  $\cos^2x = 1 - \sin^2x$  almashtirish berilgan tenglamani  $3\sin^2x + 4\sin x + 2 - 2\sin^2x - 7 = 0$  yoki  $\sin^2x + 4\sin x - 5 = 0$  ko'rinishga keltiradi. Oxirgi tenglamadan  $\sin x = z$  almashtirish bajarsak,  $z^2 + 4z - 5 = 0$  kvadrat tenglama hosil bo'ladi. Bu kvadrat tenglama  $z_1 = -5$ ,  $z_2 = 1$  ildizlarga ega.  $z = \sin x$  ekanligini e'tiborga olsak,  $\sin x = -5$  va  $\sin x = 1$  tenglamalar hosil bo'ladi. Ularning birinchisi yechimga ega emas, ikkinchisi esa  $x = \frac{\pi}{2} + 2k\pi$ ,  $k \in \mathbb{Z}$  yechimlarga ega.

2) Chap qismi  $\sin x$  va  $\cos x$  ga nisbatan ratsional funksiya bo'lgan  $R(\sin x, \cos x) = 0$  tenglama. Oldingi bandlarda ko'rsatib o'tilganidek,  $u$  va  $v$  ga nisbatan *ratsional funksiya* deb, qiymatlari  $u$  va  $v$  larni qo'shish, ko'paytirish va bo'lish orqali hosil bo'ladigan funksiyaga aytiladi.  $R(\sin x, \cos x) = 0$  tenglamada:

a) agar  $\sin x$  (yoki  $\cos x$ ) faqat juft daraja bilan qatnashayotgan bo'lsa,  $\cos x = u$  (mos ravishda  $\sin x = u$ ) almashtirish bajariladi;

b) agar bir vaqtda  $\sin x$  ifoda  $-\sin x$  ga,  $\cos x$  esa  $-\cos x$  ga almashtirilganda  $R(\sin x; \cos x)$  funksiya o'zgarmasa, ya'ni  $R(\sin x; \cos x) = R(-\sin x; -\cos x)$  bo'lsa,  $\operatorname{tg} u = z$  almashtirish bajariladi.

2 - m i s o l .  $\cos^4x + 3\sin x - \sin^4x - 2 = 0$  tenglamani yechamiz.

Y e c h i s h .  $\cos x$  funksiya faqat juft daraja bilan qatnashmoqda.  $\cos^4x = (1 - \sin^2x)^2 = 1 - 2\sin^2x + \sin^4x$  bo'lganidan tenglama faqat sinusga bog'liq:  $2\sin^2x - 3\sin x + 1 = 0$ ; endi bu tenglama  $\sin x = u$  almashtirish bilan  $2u^2 - 3u + 1 = 0$  ko'rinishga keladi. Buning ildizlari:  $u_1 = \frac{1}{2}$ ,  $u_2 = 1$ . Shu tariqa masala  $\sin x = \frac{1}{2}$  va  $\sin x = 1$  eng sodda trigonometrik tenglamalarni yechishga keladi. Bu tenglamalar berilgan tenglamaning barcha yechimlarini beradi:

$$x = (-1)^k \frac{\pi}{6} + \pi k, k \in \mathbb{Z}; x = \frac{\pi}{2} + 2\pi k, k \in \mathbb{Z}.$$

3 - m i s o l .  $\sin^2x + 2\sin 2x + 5\cos^2x - 4 = 0$  tenglamani yechamiz.

Y e c h i s h . Tenglamani  $\sin^2x + 4\sin x \cos x + 5\cos^2x - 4 = 0$  ko'rinishda yozib olaylik. Bu tenglamani  $x$  ning  $\cos x$  ni nolga aylantiradigan hech qanday qiymati qanoatlantirmaydi, chunki  $\cos x = 0$  bo'lganda  $\sin^2x = 1$  bo'lib, tenglamadan  $-3 = 0$  noto'g'ri tenglik hosil bo'ladi. Bundan tashqari,  $\sin x$  va  $\cos x$  oldidagi ishoralar bir vaqtda o'zgartirilganda, tenglikning chap qismi o'zgarmaydi. Demak,  $\operatorname{tg} x = u$  almashtirishni bajarish mumkin.

Tenglamaning ikkala qismini  $\cos^2 x$  ga bo'lamiz:

$$\operatorname{tg}^2 x + 4 \operatorname{tg} x + 5 - \frac{4}{\cos^2 x} = 0.$$

$$\frac{1}{\cos^2 x} = 1 + \operatorname{tg}^2 x \text{ bo'lgani uchun}$$

$$3 \operatorname{tg}^2 x - 4 \operatorname{tg} x - 1 = 0$$

tenglama hosil bo'ladi. Bu tenglamada  $\operatorname{tg} x = t$  almashtirish bajarsak,  $3t^2 - 4t - 1 = 0$  tenglamaga ega bo'lamiz. Bu kvadrat tenglama  $\frac{2 \pm \sqrt{7}}{3}$  ildizlarga ega. Topilgan ildizlar yordamida berilgan tenglamaning barcha ildizlarini aniqlaymiz:

$$x = \operatorname{arctg} \frac{2 - \sqrt{7}}{3} + \pi k, \quad k \in \mathbb{Z}; \quad x = \operatorname{arctg} \frac{2 + \sqrt{7}}{3} + \pi k, \quad k \in \mathbb{Z}.$$

3)  $R(\sin x; \cos x) = 0$  tenglamaning chap qismi sinus va kosinusga nisbatan bir jinsli funksiya, ya'ni, agar  $\sin x$  va  $\cos x$  bir vaqtda biror  $\lambda$  ga ko'paytirilsa, tenglamaning chap qismi  $\lambda^n$  ga ko'paytirilgan bo'ladi:  $R(\lambda \sin x; \lambda \cos x) = \lambda^n R(\sin x; \cos x)$ , bunda  $n$  - funksiyaning bir jinslilik darajasi, o'zgarmas miqdor. Bu holda tenglikning ikkala qismi  $\cos^n x$  ga bo'linadi va  $\operatorname{tg} x = u$  almashtirish bajariladi. Agar tenglikning barcha hadlari  $\cos^m x$  ga bo'linadigan bo'lsa,  $u$  holda  $\cos^m x$  qavsdan tashqari chiqarilsa, berilgan tenglama ikki tenglamaga ajraladi.

4 - misol.  $9 \cos^6 x - 4 \sin^3 x \cos^3 x = 0$  tenglamani yechamiz.

Yechish. Tenglamaning barcha hadlari  $\cos^3 x$  ga bo'linadi.  $\cos^3 x$  ni qavsdan tashqariga chiqaramiz:

$$\cos^3 x (9 \cos^3 x - 4 \sin^3 x) = 0 \Rightarrow \begin{cases} \cos^3 x = 0, \\ 9 \cos^3 x - 4 \sin^3 x = 0. \end{cases}$$

$\cos x = 0$  tenglama izlanayotgan yechimning bir turkumini beradi:  $x = \frac{\pi}{2} + \pi k, \quad k \in \mathbb{Z}$ . Ikkinchi tenglama  $\cos x$  va  $\sin x$  ga nisbatan bir jinsli. Uning ikkala qismini  $\cos^3 x$  ga bo'lamiz ( $\cos x \neq 0$ , ya'ni  $x \neq \pm \frac{\pi}{2} + \pi k, \quad k \in \mathbb{Z}$  hol qaralyapti). Natijada:  $9 - 4 \operatorname{tg}^3 x = 0$  tenglamaga ega bo'lamiz. Bu tenglama yechimning yana bir turkumini beradi:  $x = \operatorname{arctg} \sqrt[3]{\frac{9}{4}} + \pi k, \quad k \in \mathbb{Z}$ .

Ba'zan oddiy almashtirishlar tenglamani unga teng kuchli bir jinsli tenglamaga keltirishi mumkin. Masalan,  $\cos^2 x - 6 \sin x \cos x = 4$  ning o'ng qismini  $\sin^2 x + \cos^2 x$  ga (ya'ni 1 ga) ko'paytirish

tenglamani  $\cos^2 x - 6\sin x \cos x = 4(\cos^2 x + \sin^2 x)$  yoki  $3\cos^2 x + 6\sin x \cos x + 4\sin^2 x = 0$  bir jinsli tenglamaga aylantiradi. 3- misolda ham shunday yo'l tutish mumkin edi.

4) Agar trigonometrik tenglamada  $x$  dan boshqa yana  $2x$ ,  $3x$  va hokazo argumentning ko'p karrali trigonometrik funksiyalari ham qatnashayotgan bo'lsa, ular ikkilangan, uchlangan argument trigonometrik funksiyalari yordamida faqat bir argumentga bog'liq trigonometrik funksiya orqali ifodalanishi mumkin.

5 - misol.  $\sin 3x \sin x - \sin^2 2x + \sin x - 0,25 = 0$  tenglamani yechamiz.

**Yechish.**  $\sin 2\varphi = 2\sin\varphi \cos\varphi$ ,  $\sin 3\varphi = 3\sin\varphi - 4\sin^3\varphi$ ,  $\cos^2\varphi = 1 - \sin^2\varphi$  formulalardan foydalanib, tenglamani ushbu ko'rinishga keltiramiz:

$$3\sin^2 x - 4\sin^4 x - 4\sin^2 x \cdot (1 - \sin^2 x) + \sin x - 0,25 = 0$$

yoki ixchamlashtirishlardan so'ng:  $\sin^2 x - \sin x + 0,25 = 0$ .

**Yechimi:**  $x = (-1)^k \cdot 30^\circ + 180^\circ k$ ,  $k \in \mathbb{Z}$ .

6 - misol.  $\cos 3t \sin 6t - \cos 4t \sin 5t = 0$  tenglamani yechamiz.

**Yechish.** Karrali argument trigonometrik funksiyalari formulalaridan foydalansak, ifoda ancha murakkab ko'rinishga keladi. Bu o'rinda ko'paytmani yig'indiga aylantirish formulalaridan kelib chiqadigan quyidagi tengliklardan foydalanish qulay:

$$\cos 3t \sin 6t = \frac{1}{2} \sin 9t + \frac{1}{2} \sin 3t,$$

$$\cos 4t \sin 5t = \frac{1}{2} \sin 9t + \frac{1}{2} \sin t.$$

Bu ifodalar berilgan tenglamaga tatbiq etilsa va shakl almash-tirishlar bajarilsa,  $\sin 3t - \sin t = 0$  yoki  $2\sin t \cos 2t = 0$  tenglama hosil bo'ladi. Uning yechimlari  $t = \pi k$ ;  $t = \frac{\pi}{4} + \frac{\pi k}{2}$ ,  $k \in \mathbb{Z}$  son-lardan iborat. Bu sonlar berilgan tenglamaning barcha yechim-laridir.

5)  $a \sin x + b \cos x = c$  ko'rinishdagi tenglamalarni yechishning eng qulay usuli yordamchi burchak kiritish usulidir.

Agar  $c = 0$  bo'lsa, yechish usuli bizga tanish bo'lgan bir jinsli tenglama hosil bo'ladi.

$c \neq 0$ ,  $a^2 + b^2 \neq 0$  bo'lsin. Tenglamaning ikkala tomonini ham  $\sqrt{a^2 + b^2}$  ga bo'lamiz:

$$\frac{a}{\sqrt{a^2 + b^2}} \cos x + \frac{b}{\sqrt{a^2 + b^2}} \sin x = \frac{c}{\sqrt{a^2 + b^2}}.$$

$$\left(\frac{a}{\sqrt{a^2+b^2}}\right)^2 + \left(\frac{b}{\sqrt{a^2+b^2}}\right)^2 = 1 \text{ bo'lgani uchun } \frac{a}{\sqrt{a^2+b^2}} = \sin \varphi$$

va  $\frac{b}{\sqrt{a^2+b^2}} = \cos \varphi$  tengliklar o'rinli bo'ladigan  $\varphi$  son mavjuddir.

Bu yerda,

$$\cos x \sin \varphi + \sin x \cos \varphi = \frac{c}{\sqrt{a^2+b^2}} \text{ yoki } \sin(x + \varphi) = \frac{c}{\sqrt{a^2+b^2}}$$

tenglama hosil bo'ladi. Hosil bo'lgan bu tenglama  $\frac{c}{\sqrt{a^2+b^2}} \leq 1$  bo'lgandagina yechimga ega:  $x = -\varphi + (-1)^n \arcsin \frac{c}{\sqrt{a^2+b^2}} + n\pi, n \in \mathbb{Z}$ .

7 - misol.  $\sqrt{3} \cos x + \sin x = 2$  tenglamani yechamiz.

Yechish. Tenglamani ikkala tomonini  $\sqrt{(\sqrt{3})^2 + 1^2} = 2$  ga bo'lsak,  $\frac{\sqrt{3}}{2} \cos x + \frac{1}{2} \sin x = 1$  hosil bo'ladi.  $\frac{\sqrt{3}}{2} = \sin \frac{\pi}{3}$ ,  $\frac{1}{2} = \cos \frac{\pi}{3}$  bo'lganligi uchun

$$\sin \frac{\pi}{3} \cos x + \cos \frac{\pi}{3} \sin x = 1 \Rightarrow \sin \left(x + \frac{\pi}{3}\right) = 1 \Rightarrow$$

$$\Rightarrow x + \frac{\pi}{3} = \frac{\pi}{2} + 2k\pi \Rightarrow x = \frac{\pi}{6} + 2k\pi, k \in \mathbb{Z}.$$

8 - misol.  $2\sin x + 3\cos x = 4$  tenglamani yechamiz.

Yechish.  $\frac{4}{\sqrt{2^2+3^2}} > 1$  bo'lgani uchun tenglama yechimga ega emas.

6) Ba'zi trigonometrik tenglamalar chap yoki o'ng tomonini baholash yo'li bilan oson yechiladi.

9 - misol.  $\cos 2x + \cos 3x + \cos 4x = 3$  tenglamani yechamiz.

Yechish. Tenglamani chap tomonidagi yig'indi  $\cos 2x = 1$ ,  $\cos 3x = 1$ ,  $\cos 4x = 1$  tengliklar bir vaqtda bajarilgandagina 3 ga teng bo'ladi. Bu tengliklar bir vaqtda bajarila olmaydi. Demak, tenglama yechimga ega emas.

10 - misol.  $1 - \cos^2 3x + \sin^2 2x = 0$  tenglamani yechamiz.

Yechish. Tenglamani quyidagicha yozib olamiz:  $\sin^2 2x + \sin^2 3x = 0$ . Bundan,  $\sin^2 2x = \sin^2 3x = 0$  sistema hosil bo'ladi.

$\sin 2x = 0$  tenglama  $x = \pi k$ ,  $x = \frac{\pi}{2} + \pi n$  ildizlarga ega.  $x = \frac{\pi}{2} + \pi n$ ,  $n \in Z$  sonlari  $\sin^2 3x = 0$  tenglamani qanoatlantirmaydi.  $x = \pi k$  ildiz esa  $\sin^2 3x = 0$  tenglamani qanoatlantiradi. Demak, berilgan tenglama  $x = \pi k$ ,  $k \in Z$  ildizlarga ega.

7)  $P(\sin x \pm \cos x, \sin x \cos x) = 0$  ko'rinisdagi tenglamalar (bu yerda  $P$  bilan  $\sin x \pm \cos x$  ga nisbatan ratsional funksiya belgilangan). Bu kabi tenglamalar  $\sin x \pm \cos x = t$  almashtirish yo'li bilan yechiladi.

**11 - misol.**  $\sin x + \cos x = 1 - 2\sin x \cos x$  tenglamani yechamiz.

**Yechish.**  $\sin x + \cos x = t$  almashtirish kiritsak,  $\sin^2 x + 2\sin x \cos x + \cos^2 x = t^2$  yoki  $2\sin x \cos x = t^2 - 1$  bo'ladi va tenglama  $t = 1 - (t^2 - 1)$  ko'inishga keladi. Bu tenglamaning  $t_1 = 1$ ;  $t_2 = -2$  ildizlari yordamida  $\sin x + \cos x = 1$ ;  $\cos x + \sin x = -2$  tenglamalarni hosil qilamiz.

$\sin x + \cos x = 1$  tenglama  $x = (-1)^k \frac{\pi}{4} - \frac{\pi}{4} + k\pi$ ,  $k \in Z$  ildizlarga ega.

$\cos x + \sin x = -2$  tenglama esa yechimga ega emas. Demak, berilgan tenglama  $x = (-1)^k \frac{\pi}{4} - \frac{\pi}{4} + k\pi$ ,  $k \in Z$  ildizlarga ega.



## Mashqlar

**1.135.** Tenglamani yeching:

- |   |   |
|---|---|
| 1) $2\sin^2 x + \cos^2 x - 2 = 0$ ;       | 2) $2\sin^2 x + \cos x = 0$ ;               |
| 3) $\sin x \cos x = 0$ ;                  | 4) $\sin^2 x + \sin x - \cos^2 x + 1 = 0$ ; |
| 5) $\sin x \cos x = \frac{\sqrt{3}}{4}$ ; | 6) $\cos^2 2x + \sin 2x = 2$ .              |

**1.136.** Bir jinsli va unga keltiriladigan tenglamani yeching:

- $\sin^2 x - 2\sin x \cos x + \cos^2 x = 0$ ;
- $7\cos^2 x - 3\sin^2 x = 0$ ;
- $\cos^2 2x - 10\sin 2x \cos 2x + 21\sin^2 2x = 0$ ;
- $8\sin^2 x - \cos^2 x = 0$ ;
- $\cos^2 x - 2\cos 2x - 4\sin^2 x = 0$ ;
- $\sin^2 3x + 7\cos^2 3x = 6\sin 3x \cos 3x$ ;
- $\cos^6 x + \cos^4 x \sin^2 x = \cos^3 x \sin^3 x + \cos^2 x \sin^4 x$ ;
- $2\sin^4 x - 6\sin^3 x \cos x - 23\cos^2 x \sin^2 x = 0$ ;



9)  $10 \cos^2 \frac{x}{2} - 3 \sin x - 5 = 0;$

11)  $\sin^6 x + \cos^6 x = \frac{1}{4};$

10)  $\cos^4 x - \sin^4 x = 2 \sin^2 x;$

12)  $\sin^8 x + \cos^8 x = \cos^2 2x.$

**1.137.** O'rniga qo'yish usulidan foydalanib yeching:

1)  $\cos^2 x + 1 = 2 \cos x;$

2)  $3 \cos^2 x \sin x + 1 = 3 \cos^2 x + \sin x;$

3)  $6 \cos^3 x + 6 \sin^2 x - 3 \cos x - 3 = 0;$

4)  $5 \sin^2 x \cos x + 6 \cos^2 x - 10 \cos x + 6 = 0;$

5)  $1 + \sin^2 2x = (1 - \cos^2 x)^2.$

**1.138.** Tenglamalarni yeching:

1)  $\cos 2x + \cos x = 0;$

2)  $\cos 3x = 2 \cos 2x - 1;$

3)  $2 \cos^2 x = 4 \sin x \cos x - 1;$

4)  $\cos^2 x - 3 \sin x \cos x = -1;$

5)  $\left(\sin x - \frac{1}{\sin x}\right)^2 + \left(\cos x - \frac{1}{\cos x}\right)^2 = 1;$

6)  $2 \cos\left(\frac{\pi}{2} + \sqrt{x}\right) + 1 = 0;$

7)  $(\cos 5x + \cos 7x)^2 = (\sin 5x + \sin 7x)^2;$

8)  $\sin^2 4x - \cos^2 x = 2 \sin 4x \cos^4 x;$

9)  $\sin^3 2x - 5 \sin^2 2x + 4 = 0.$

**1.139.** Tenglamani  $\sin x + \cos x = t$  almashtirish yordamida yeching:

1)  $2(\sin x + \cos x) + \sin 2x + 1 = 0;$

2)  $\sin x + \cos x = 1 + \frac{\sin 2x}{2};$

3)  $\sin^4 2x + \cos^4 2x = \sin 2x \cos 2x.$

**1.140.** Tenglamani baholash usuli bilan yeching:

1)  $2 \sin^8 x + 3 \cos^8 x = 5;$

2)  $(\cos 2x - \cos 4x)^2 = 4 + \cos^2 3x;$

3)  $\sin 3x + \cos 2x + 2 = 0.$

**1.141.** Tenglamani yordamchi burchak kiritish usuli bilan yeching:

1)  $12 \cos x - 5 \sin x = -13;$

2)  $\sin x + \cos x = \sqrt{2};$

3)  $\sqrt{3} \sin x - \cos x = 1.$

**6. Universal almashtirish.** 3-§ ning 4-bandidagi (9) va (10) formulalardan foydalanib,  $x \neq (2k + 1)\pi$ ,  $k \in \mathbb{Z}$  qiymatlar uchun quyidagi munosabatlarni hosil qilamiz:

$$\sin x = \frac{2 \operatorname{tg} \frac{x}{2}}{1 + \operatorname{tg}^2 \frac{x}{2}}; \quad (1)$$

$$\cos x = \frac{1 - \operatorname{tg}^2 \frac{x}{2}}{1 + \operatorname{tg}^2 \frac{x}{2}}. \quad (2)$$

Agar  $R(\sin x; \cos x) = 0$  tenglamada (1) va (2) almashtirishlar bajarilib,  $\operatorname{tg} \frac{x}{2} = z$  o'rniga qo'yish tabiiq etilsa, chap tomoni  $z$  ga nisbatan ratsional funksiya bo'lgan tenglama hosil bo'ladi:

$$R\left(\frac{2z}{1+z^2}; \frac{1-z^2}{1+z^2}\right) = 0. \quad (3)$$

(3) tenglama ildizlarini (agar bu ildizlar mavjud bo'lsa) birma-bir  $\operatorname{tg} \frac{x}{2} = z$  ga qo'yib,  $x$  ning izlanayotgan qiymatlari topiladi.  $\operatorname{tg} \alpha$  ifoda  $\alpha = \frac{\pi}{2} + k\pi$ ,  $k \in Z$  qiymatlarda aniqlanmaganligi sababli  $x$  ning  $x = (2k + 1)\pi$ ,  $k \in Z$  qiymatlari alohida tekshiriladi.

**Misol.**  $3 \sin t - \cos t = 3$  tenglamani yechamiz.

**Yechish.** (1) va (2) formulalardan foydalanib,  $\sin t$  va  $\cos t$  ni  $\operatorname{tg} \frac{t}{2}$  orqali ifodalaymiz, so'ng  $\operatorname{tg} \frac{t}{2} = z$  almashtirishni kiritamiz.

Natijada,  $\frac{6z}{1+z^2} = \frac{2z^2+4}{1+z^2}$  ratsional tenglama hosil bo'ladi. Uning

ildizlari  $z_1 = 1$ ,  $z_2 = 2$ . Ularni ketma-ket  $\operatorname{tg} \frac{t}{2} = z$  ga qo'yamiz.

$\operatorname{tg} \frac{t}{2} = 1$  tenglamadan  $t = \frac{\pi}{2} + 2\pi k$ ,  $k \in Z$  ni,  $\operatorname{tg} \frac{t}{2} = 2$  tenglamadan esa  $t = 2 \operatorname{arctg} 2 + 2\pi k$ ,  $k \in Z$  ni hosil qilamiz.



## Mashqlar

**1.142.**  $a \sin x + b \cos x = c$  tenglamani yeching. Tenglama  $a$ ,  $b$ ,  $c$  larga nisbatan qanday shartlarda yechimga ega bo'ladi?

**1.143.** Tenglamalarni yeching:

1)  $4 \sin x - 7 \cos x = 7$ ;

2)  $\frac{1 - \cos x}{1 + \sin x} = \frac{1}{2}$ ;

$$3) \sqrt{3} \cos x - \sin x = 1; \quad 4) 2 \sin\left(x + \frac{\pi}{3}\right) - \sin\left(x - \frac{\pi}{3}\right) = \sqrt{2};$$

$$5) \cos x - \cos(\pi - 2x) - 2 = 0; \quad 6) 2 \sin 6x = \sqrt{2(1 - \cos 4x)};$$

$$7) \operatorname{ctg}\left(2x + \frac{\pi}{4}\right) - \operatorname{ctg}\left(2x - \frac{\pi}{4}\right) = 0; \quad 8) \sin x \cos x \sin 2x = \frac{1}{8};$$

$$9) \sin(x + 20^\circ) + \sin(2x + 40^\circ) + \sin(3x + 60^\circ) = 0;$$

$$10) \sqrt{3} \cos^2 x + (\sqrt{3} - 1) \sin x \cos x - \sin^2 x = 0;$$

$$11) \sqrt{3} \cos x + \sin x = 0;$$

$$12) \sqrt{3 + 2(2 \sin x - \cos 2x)} + \sqrt{3 - 2(2 \sin x + \cos 2x)} = 2;$$

**1.144.** Grafik yordamida taqribiy yeching:

$$1) \sin x = x - 0,5; \quad 2) \sin x = x + 1; \quad 3) x = 1 + 0,5 \sin x.$$

**7. Trigonometrik tenglamalar sistemasi.** Trigonometrik tenglamalar sistemasini yechishda yuqorida ko'rilgan tenglamalarni yechish usullaridan va trigonometrik formulalardan foydalaniladi.

Quyida tenglamalar sistemasini yechishning o'ziga xos xususiyatlari bilan tanishamiz.

1 - misol. 
$$\begin{cases} 5 \sin x = \sin y, \\ 3 \cos x = 2 - \cos y \end{cases}$$
 tenglamalar sistemasini yechamiz.

Yechish. Berilgan sistemani 
$$\begin{cases} 5 \sin x = \sin y, \\ 2 - 3 \cos x = \cos y \end{cases}$$
 ko'rinishda yozib olamiz. Bu sistemaning kvadratga ko'tarilgan tenglamalarini hadma-had qo'shsak,

$$25 \sin^2 x + 4 - 12 \cos x + 9 \cos^2 x = 1$$

yoki

$$16 \cos^2 x + 12 \cos x - 28 = 0$$

tenglama hosil bo'ladi. Hosil bo'lgan bu tenglamani  $\cos x$  ga nisbatan yechib,  $\cos x = 1$ ,  $\cos x = -\frac{7}{4}$  tenglamalarga ega bo'lamiz.

$\cos x = -\frac{7}{4}$  tenglama yechimga ega emas. Demak,  $\cos x = 1$  bo'lishi zarur.  $\cos x = 1$ , ya'ni  $x = 2\pi n$ ,  $n \in \mathbb{Z}$  da  $\sin x = 0$  bo'lgani uchun

$\begin{cases} 5 \cdot 0 = \sin y, \\ 2 - 3 \cdot 1 = \cos y \end{cases}$  sistemaga ega bo'lamiz. Bu sistemadan,  $y = (2k + 1)\pi$ ,  $k \in \mathbb{Z}$  ekanligi topiladi.

Javob:  $x = 2\pi n$ ,  $n \in \mathbb{Z}$ ,  $y = (2k + 1)\pi$ ,  $k \in \mathbb{Z}$ .

2-misol.  $\begin{cases} \sin x + \sin y = \frac{4}{3}, \\ x + y = \frac{\pi}{3} \end{cases}$  tenglamalar sistemasini yechamiz.

Yechish:

$$\begin{cases} \sin x + \sin y = \frac{4}{3}, \\ x + y = \frac{\pi}{3} \end{cases} \Rightarrow \begin{cases} 2 \sin \frac{x+y}{2} \cos \frac{x-y}{2} = \frac{4}{3}, \\ x + y = \frac{\pi}{3} \end{cases} \Rightarrow$$

$$\Rightarrow \begin{cases} 2 \sin \frac{\pi}{6} \cos \frac{x-y}{2} = \frac{4}{3}, \\ x + y = \frac{\pi}{3} \end{cases} \Rightarrow \begin{cases} \cos \frac{x-y}{2} = \frac{4}{3}, \\ x + y = \frac{\pi}{3}. \end{cases}$$

$\left| \cos \frac{x-y}{2} \right| \leq 1$  shart bajarilmaganligi uchun sistema yechimga ega emas.



## Mashqlar

**1.145.** Trigonometrik tenglamalar sistemasini yeching:

1)  $\begin{cases} \sin x + \sin y = 1, \\ x + y = \frac{\pi}{3}; \end{cases}$

2)  $\begin{cases} 4 \sin x \cos y = 1, \\ 3 \operatorname{tg} x - \operatorname{tgy} = 0; \end{cases}$

3)  $\begin{cases} 4 \cos x \cos y = 3, \\ 4 \sin x \sin y = -1; \end{cases}$

4)  $\begin{cases} \cos x + \cos y = -1,6, \\ x + y = \frac{2\pi}{3}. \end{cases}$

**8. Trigonometrik tengsizliklarni isbotlash.** Trigonometrik tengsizliklarni isbotlash masalasi ba'zan algebraik tengsizliklarni isbotlash masalasiga keltiriladi.

1-misol.  $4 \cos x - 3 \sin x \leq 5$  tengsizlikni isbot qilamiz.

Yechish.  $\operatorname{tg} \frac{x}{2} = z$ ,  $x \neq \pi + 2\pi k$ ,  $k \in \mathbb{Z}$  universal o'rniga qo'yish tengsizlikni quyidagi ko'rinishga keltiradi:

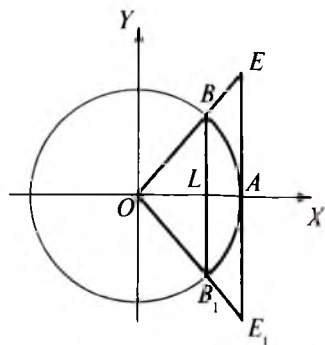

I.45-rasm.

$$\frac{4(1-z^2)}{1+z^2} - \frac{6z}{1+z^2} \leq 5 \Rightarrow 9z^2 +$$

$$+6z+1 \geq 0 \Rightarrow (3z+1)^2 \geq 0 \quad (1)$$

(1) tengsizlik  $z$  ning har qanday qiymatida o'rinli. Demak, berilgan tengsizlik barcha  $x \neq \pi + 2\pi k$ ,  $k \in \mathbb{Z}$  larda bajariladi. Tekshirish tengsizlikning  $x = \pi + 2\pi k$ ,  $k \in \mathbb{Z}$  uchun ham o'rinli ekanini ko'rsatadi.

2 - misol.  $ABC$  uchburchakda

$\operatorname{tg}^2 \frac{A}{2} + \operatorname{tg}^2 \frac{B}{2} + \operatorname{tg}^2 \frac{C}{2} \geq 1$  tengsizlikning bajarilishini isbot qilamiz.

Isbot.  $ABC$  uchburchakning  $A$ ,  $B$  va  $C$  burchaklari uchun

$$\left(\operatorname{tg} \frac{A}{2} - \operatorname{tg} \frac{B}{2}\right)^2 + \left(\operatorname{tg} \frac{A}{2} - \operatorname{tg} \frac{C}{2}\right)^2 + \left(\operatorname{tg} \frac{B}{2} - \operatorname{tg} \frac{C}{2}\right)^2 \geq 0$$

yoki

$$\operatorname{tg}^2 \frac{A}{2} + \operatorname{tg}^2 \frac{B}{2} + \operatorname{tg}^2 \frac{C}{2} \geq \operatorname{tg} \frac{A}{2} \operatorname{tg} \frac{B}{2} + \operatorname{tg} \frac{A}{2} \operatorname{tg} \frac{C}{2} + \operatorname{tg} \frac{B}{2} \operatorname{tg} \frac{C}{2}$$

munosabat o'rinli ekanligi ravshan. Bu yerda geometriya kursida ma'lum bo'lgan

$$\operatorname{tg} \frac{A}{2} \operatorname{tg} \frac{B}{2} = \frac{p-c}{p}, \quad \operatorname{tg} \frac{A}{2} \operatorname{tg} \frac{C}{2} = \frac{p-b}{p} \quad \text{va} \quad \operatorname{tg} \frac{B}{2} \operatorname{tg} \frac{C}{2} = \frac{p-a}{p}$$

tengliklardan foydalansak (bu yerda  $a$ ,  $b$ ,  $c$  — uchburchakning mos ravishda  $A$ ,  $B$ ,  $C$  burchaklari qarshisidagi tomonlar,  $p = \frac{a+b+c}{2}$ ), isbotlanishi kerak bo'lgan tengsizlikni hosil qilamiz.

3 - misol.  $0 < \alpha < \pi$  bo'lsin. U holda  $\sin \alpha < \alpha < \operatorname{tg} \alpha$  bo'lishini isbot qilamiz.

Isbot. Birlik aylanada (I.45-rasm)  $B_1OB$  va  $OEE_1$  uchburchaklarni yasaymiz,  $\cup B_1AB = 2\alpha$ ,  $\cup AB = \alpha$  bo'lsin. 1-§ ning 1-bandida keltirilgan mulohazalarga ko'ra  $BL < \cup AB < AE$  bo'ladi. Bundan

$$\sin \alpha < \alpha < \operatorname{tg} \alpha \quad (1)$$

bo'ladi.



## Mashqlar

**1.146.** Tengsizlikni isbotlang:

1)  $\operatorname{ctg} 2\alpha < 0,5 \operatorname{ctg} \alpha$ ,  $0 < \alpha < \pi$ ;

2)  $\sin^3 \alpha - \sin^6 \alpha \leq 0,25$ ;

3)  $-\sqrt{3} \leq \frac{3 \sin \alpha}{2 + \cos \alpha} \leq \sqrt{3}$ ;

4)  $\cos A \cos B \cos C \leq \frac{1}{8}$ ,  $A + B + C = 180^\circ$ ;

5)  $\cos(\cos x) > 0$ , bunda  $x \in R$ ;

6)  $\cos x - \sin x - \cos 2x > 0$ ;

7)  $\sqrt{5 - 2 \sin x} \geq 6 \sin x - 1$ ;

8) aniqlanish sohasidan olingan ixtiyoriy  $x$  da  $|\operatorname{tg} x + \operatorname{ctg} x| \geq 2$ ;

9)  $|3 \sin x - 4 \cos x| \leq 5$ ;

10)  $\alpha$  va  $\beta$  o'tkir burchaklar uchun  $\sin(\alpha + \beta) < 2 \sin \alpha + \sin \beta$ ;

11) agar  $\alpha$  va  $\beta$  o'tkir burchaklar uchun  $\sin(\alpha + \beta) = 2 \sin \alpha$  o'rinli bo'lsa, u holda  $\alpha < \beta$ ;

12)  $\alpha$  ning barcha qiymatlarida  $\sin \alpha \cos \alpha \leq 0,5$  bo'ladi;

13)  $\frac{1}{\sin^2 \alpha} + \frac{1}{\cos^2 \alpha} \geq 4$ ;

14)  $\frac{1}{\sin^4 \alpha} + \frac{1}{\cos^4 \alpha} \geq 8$ .

**9. Eng sodda trigonometrik tengsizliklarni yechish.**  $\sin x > m$ ,  $\cos x > m$ ,  $\operatorname{tg} x > m$ ,  $\operatorname{ctg} x > m$  kabi ko'rinishdagi tengsizliklarni yechishda koordinatali aylanadan yoki trigonometrik funksiyalarning grafiklaridan foydalanamiz.

1 - misol. a)  $\sin \alpha > 0$ ; b)  $\sin \alpha > m$ ,  $1 \leq m < 1$ ; v)  $\sin \alpha < m$  tengsizliklarni yechamiz.

**Yechish.** a)  $\sin \alpha > 0$  ning yechimlar to'plami sinusoidaning absissalar o'qidan yuqorida joylashgan bo'laklari bilan aniqlanadi (I.46-a rasm). Bu bo'laklardan biri absissalar o'qining  $(0; \pi)$  oralig'iga, qolganlari undan  $2\pi k$ ,  $k \in Z$  uzoqliklarda joylashgan oraliqlarga mos keladi. Demak,  $2\pi k < \alpha < (2k + 1)\pi$ ,  $k \in Z$  ko'rinishdagi oraliqlarda yotuvchi  $\alpha$  sonlargina yechim bo'ladi.

b)  $\sin \alpha > m$  tengsizlikni yechamiz, bunda  $-1 \leq m < 1$ . Birlik aylananing ordinatalari  $m$  dan katta bo'lgan nuqtalari  $y = m$  to'g'ri chiziqdan yuqorida joylashadi. Ular  $MBN$  yoyni hosil qiladi

(I.46-b rasm). Bu yoyga  $M(\alpha_0)$  va  $N(\pi - \alpha_0)$  nuqtalar kirmaydi. Shunday qilib,  $\sin \alpha > m$  tengsizlikning yechimi  $(\alpha_0; \pi - \alpha_0)$  interval yordamida aniqlanadi.  $\alpha_0 = \arcsin m$  va  $y = \sin x$  funksiya davriy funksiya bo'lgani uchun berilgan tengsizlikning barcha yechimlar to'plamini

$$\bigcup_{k \in \mathbb{Z}} (\arcsin m + 2k\pi; \pi - \arcsin m + 2k\pi)$$

yoki

$$\arcsin m + 2k\pi < \alpha < \pi - \arcsin m + 2k\pi, k \in \mathbb{Z}$$

ko'rinishda yozamiz.

$\sin \alpha > m$  tengsizlik  $m \geq 1$  da bajarilmaydi,  $m < -1$  da esa barcha  $\alpha$  larda bajariladi.

d)  $\sin \alpha < m$  tengsizlikni yechish  $\alpha = -z$  o'rniga qo'yish orqali yuqorida qaralgan holga keladi:  $\sin z > -m$ . Uning barcha yechimlarini yozamiz:

$$\arcsin(-m) + 2\pi k < z < \pi - \arcsin(-m) + 2\pi k, k \in \mathbb{Z}.$$

$\arcsin(-m) = -\arcsin m$  va  $z = -\alpha$  bo'lgani uchun berilgan tengsizlikning barcha yechimlari quyidagicha bo'ladi:

$$-\pi - \arcsin m + 2\pi k < \alpha < \arcsin m + 2\pi k, k \in \mathbb{Z}.$$

2-misol. a)  $\cos \alpha > m$ ; b)  $\cos \alpha < m$  tengsizliklarni yechamiz.

Yechish. a)  $m \geq 1$  da tengsizlik yechimga ega emas,  $m < -1$  da esa  $\alpha$  ning barcha qiymatlari tengsizlikni qanoatlantiradi. Biz  $-1 \leq m < 1$  bo'lgan holni qaraymiz. I.41-d rasmga qaralganda  $m < \cos \alpha \leq 1$  ga  $B_2AB_1$  yoy mos keladi, bunda  $B_1(\alpha_0)$  va  $B_2(-\alpha_0)$  lar  $x = m$  to'g'ri chiziq bilan koordinatali aylananing kesishish nuqtalari,  $A(0)$  - hisob boshi nuqtasi. Demak,  $\cos \alpha > m$  tengsizlikning yechimi  $-\alpha_0 < \alpha < \alpha_0$  yoki  $-\arccos m < \alpha < \arccos m$ , yoki funksiya davri e'tiborga olinsa,  $-\arccos m + 2\pi k < \alpha < \arccos m + 2\pi k, k \in \mathbb{Z}$  bo'ladi.

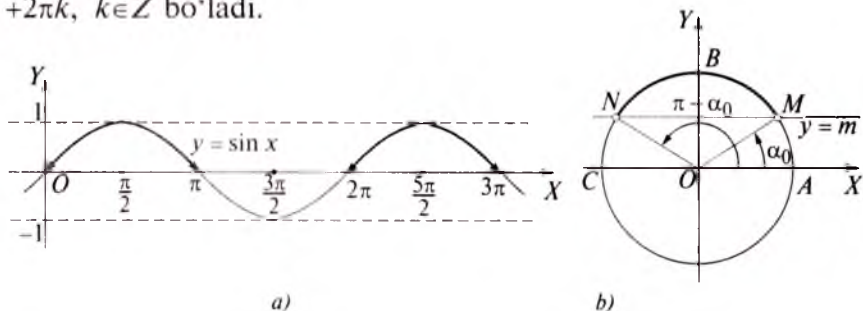

I.46-rasm.

b)  $\cos \alpha < m$  tengsizligini yechish  $\alpha = \pi - z$  almashtirish orqali yuqorida qaralgan tengsizlikka keltiriladi:  $\cos z > -m$ . Bundan  $-\arccos(-m) + 2k\pi < z < \arccos(-m) + 2k\pi, k \in \mathbb{Z}$  ni topamiz.  $z = \pi - \alpha$  va  $\arccos(-m) = \pi - \arccos m$  bo'lgani uchun

$$\arccos m + 2k\pi < \alpha < 2(k+1)\pi - \arccos m, k \in \mathbb{Z}$$

bo'ladi.

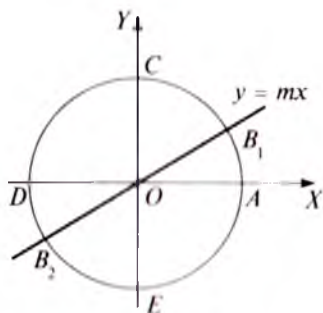

1.47-rasm.

3 - misol.  $\operatorname{tg} \alpha < m$  va  $\operatorname{tg} \alpha > m$  tengsizliklar yechimini topamiz.

**Yechish.**  $\arctg m$  ta'rifidan foydalanamiz (1.47-rasm).  $B_1(\alpha_0)$  nuqta  $EAC$  yarim aylananani  $EAB_1$  va  $B_1C$  yoylarga ajratadi, bunda  $E(-\frac{\pi}{2})$  va  $C(\frac{\pi}{2})$ . Undan  $E, B_1, C$  nuqtalar chiqariladi.  $EAB_1$  yoyda  $\operatorname{tg} \alpha < m$ ,  $B_1C$  yoyda esa  $\operatorname{tg} \alpha > m$  tengsizlik bajariladi. Demak,  $\operatorname{tg} \alpha < m$  tengsizlikning yechimi

$$-\frac{\pi}{2} + k\pi < \alpha < \arctg m + k\pi, k \in \mathbb{Z},$$

$\operatorname{tg} \alpha > m$  tengsizlik yechimi esa

$$\arctg m + k\pi < \alpha < \frac{\pi}{2} + k\pi, k \in \mathbb{Z}$$

bo'ladi.

Shu kabi  $\operatorname{ctg} \alpha < m$ ,  $\operatorname{ctg} \alpha > m$  tengsizliklar yechimi mos ravishda  $\operatorname{arctg} m + k\pi < \alpha < \pi + k\pi, k \in \mathbb{Z}$  va  $k\pi < \alpha < \operatorname{arctg} m + k\pi, k \in \mathbb{Z}$  bo'ladi.

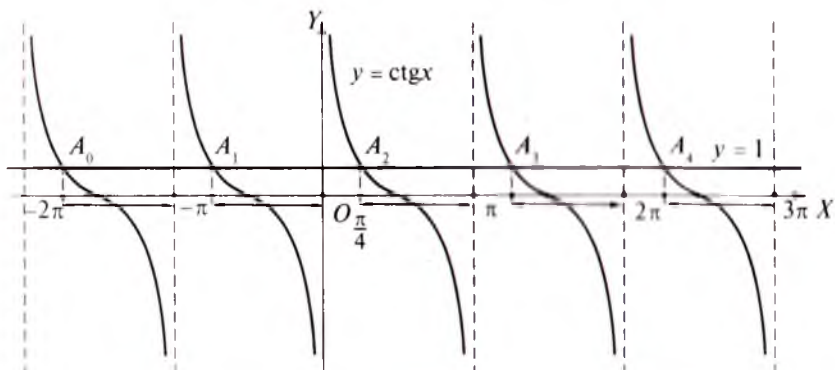

1.48-rasm.



4 - misol.  $\operatorname{ctg}x \leq 1$  tengsizlikni yechamiz.

Yechish.  $y = 1$  to'g'ri chiziq  $y = \operatorname{ctg}x$  kotangensoidani cheksi ko'p  $A_0, A_1, A_2, \dots$  nuqtalarda kesadi (I.48-rasm). Hosil bo'ladigan oraliqlardan biri  $\left[\frac{\pi}{4}; \pi\right]$ . Kotangensning davrini ham e'tiborg olib, yechimni  $\frac{\pi}{4} + \pi k < x < \pi + \pi k, k \in Z$  ko'rinishda yozamiz.



## Mashqlar

**1.147.** Tengsizlikni yeching:

- 1)  $\sin x < 0,5$ , bunda  $x \in \left[-\frac{\pi}{2}; \frac{\pi}{2}\right]$ ;
- 2)  $\sin x \leq 1$ ;
- 3)  $\sin x < \frac{\sqrt{3}}{2}, x \in [-\pi; \pi]$ ;
- 4)  $\sin x \geq -\frac{\sqrt{3}}{2}, x \in [0; 2\pi]$ ;
- 5)  $\sin x > \frac{\sqrt{2}}{2}, x \in [-\pi; \pi]$ ;
- 6)  $\sin x \leq -\frac{\sqrt{2}}{2}, x \in [0; 2\pi]$ ;
- 7)  $\sin x > -\frac{\sqrt{2}}{2}, x \in [0; 2\pi]$ .

**1.148.** Tengsizlikni yeching:

- 1)  $\cos x \leq \frac{1}{2}, x \in [0; 2\pi]$ ;
- 2)  $\cos x > \frac{1}{2}, x \in [0; 2\pi]$ ;
- 3)  $\cos x \geq \frac{\sqrt{3}}{2}, x \in [-\pi; \pi]$ ;
- 4)  $\cos x < \frac{\sqrt{3}}{2}, x \in [-\pi; \pi]$ ;
- 5)  $\cos x \geq \frac{\sqrt{3}}{2}, x \in \left[-\frac{\pi}{2}; \frac{\pi}{2}\right]$ ;
- 6)  $\cos x < \frac{\sqrt{2}}{2}, x \in [0; \pi]$ ;
- 7)  $\cos x \leq -\frac{\sqrt{2}}{2}, x \in [0; 2\pi]$ ;
- 8)  $\cos x \leq -\frac{\sqrt{3}}{2}, x \in [-\pi; \pi]$

**1.149.** Tengsizlikni yeching:

- 1)  $\operatorname{tg}x < \sqrt{3}, x \in \left(-\frac{\pi}{2}; \frac{\pi}{2}\right)$ ;
- 2)  $\operatorname{tg}x \geq \sqrt{3}, x \in \left(-\frac{\pi}{2}; \frac{\pi}{2}\right)$ ;
- 3)  $\operatorname{tg}x < 1, x \in [0; \pi]$ ;
- 4)  $\operatorname{tg}x \geq \frac{\sqrt{3}}{3}, x \in \left(-\frac{\pi}{2}; \frac{\pi}{2}\right)$ ;
- 5)  $\operatorname{ctg}x < 1, x \in \left(-\frac{\pi}{2}; \frac{\pi}{2}\right)$ ;
- 6)  $\operatorname{ctg}x \geq -1, x \in [0; \pi]$ ;
- 7)  $\operatorname{tg}x < 2$ ;
- 8)  $\operatorname{tg}2x > 2$ ;
- 9)  $\operatorname{ctg}x < -1$ .

**1.150.** Tengsizlikni yeching:

- 1)  $\sqrt{3} \cos 2x + 1 > 0, x \in [0; \pi]$ ;
- 2)  $\sqrt{3} \sin 2x + 1 \geq 0, x \in \left[-\frac{\pi}{2}; \frac{\pi}{2}\right]$ ;

$$3) -\frac{\sqrt{2}}{2} < \cos x < \frac{\sqrt{2}}{2}, x \in [0; 2\pi];$$

$$4) 0 < \sin x < \frac{\sqrt{2}}{2}, x \in [-\pi; \pi];$$

$$5) \sin^2 x > \frac{1}{4}, x \in \left[-\frac{\pi}{2}; \frac{\pi}{2}\right];$$

$$6) 4 \sin^2 x - 1 \leq 0, x \in [0; 2\pi].$$

**1.151.** Tengsizlikni yeching:

$$1) \sin x > -0,80, x \in \left[\frac{\pi}{2}; \frac{3\pi}{2}\right];$$

$$2) \sin x \leq -0,80, x \in \left[-\frac{\pi}{2}; \frac{\pi}{2}\right];$$

$$3) \cos x \geq 0,6, x \in [0; \pi];$$

$$4) \cos x < 0,7, x \in [\pi; 2\pi].$$

### 10. Trigonometrik tengsizliklarni intervallar usuli bilan yechish.

$f(t) > 0$  yoki  $f(t) < 0$  trigonometrik tengsizliklarni yechishda intervallar usulidan foydalanamiz. Shu maqsadda oldin  $f(t)$  funksiyaning  $T_0$  asosiy davri,  $f(t) = 0$  tenglamaning  $[0; T_0)$  oraliqda yotgan ildizlari va uzilish nuqtalari topiladi. Ular  $[0; T_0)$  oraliqni bir necha intervalga ajratadi. Sinash nuqtalari usuli qo'llanilib, funksiyaning intervallardagi ishoralari aniqlanadi. Funksiyaning xossalaridan, jumladan, juft-toqligidan foydalanish ishni osonlashtiradi.

1 - m i s o l.  $f(\alpha) = \cos 2\alpha - \cos 3\alpha < 0$  tengsizlikni yechamiz.

Y e c h i s h. 1)  $\cos 2\alpha$  ning davri:  $\cos(2\alpha + 2\pi) = \cos 2(\alpha + T_1)$ , bundan  $2\alpha + 2\pi = 2(\alpha + T_1)$ ,  $T_1 = \pi$ ; shu kabi  $\cos 3\alpha$  ning davri  $T_2 = \frac{2\pi}{3}$ . Bu sonlarning eng kichik umumiy bo'linuvchisi, ya'ni  $T_0 = 2\pi$  soni  $f(x)$  funksiyaning asosiy davri bo'ladi.

2)  $f(\alpha) = 0$  tenglama ildizlari  $2\alpha = \pm 3\alpha + 2\pi k$ ,  $k \in \mathbb{Z}$  munosabat bo'yicha aniqlanadi. Bizga ular ichidan  $(0; T_0)$  oraliqda yotganlarini aniqlash yetarli, qolganlari  $T_0$  davr bilan takrorlanadi. Oraliqning  $\alpha = 0$  chap uchida  $f(0) = 0$ , ya'ni  $f(x) < 0$  tengsizlik bajarilmaydi. Demak, oraliqning chap uchi ochiq qoladi. Oraliqning ichida yotgan ildizlarni topamiz. Shu maqsadda munosabatdagi  $k$  ga ketma-ket 0, 1, 2, ... qiymatlar berish va  $\alpha$  ning qiymatlari ichidan  $(0; 2\pi)$  intervalda yotganlarini ajratish kerak. Ular:  $\frac{2\pi}{5}, \frac{4\pi}{5}, \frac{6\pi}{5}, \frac{8\pi}{5}$ .

3)  $f$  funksiya son o'qida uzluksiz;

4)  $(0; 2\pi)$  oraliq  $(0; \frac{2\pi}{5}]$ ,  $[\frac{2\pi}{5}; \frac{4\pi}{5}]$ ,  $[\frac{4\pi}{5}; \frac{6\pi}{5}]$ ,  $[\frac{6\pi}{5}; \frac{8\pi}{5}]$ ,  $[\frac{8\pi}{5}; 2\pi)$  intervallarga ajraladi;

5)  $(0; \frac{2\pi}{5}]$  oraliqdan sinash nuqtasi sifatida  $\frac{\pi}{3}$  ni olaylik. Unda  $f(\frac{\pi}{3}) = \cos \frac{2\pi}{3} - \cos \frac{3\pi}{3} = -\frac{1}{2} + 1 > 0$ . Demak, bu oraliqda berilgan tengsizlik bajarilmaydi. Tekshirish tengsizlik  $[\frac{2\pi}{5}; \frac{4\pi}{5}]$ ,  $[\frac{6\pi}{5}; \frac{8\pi}{5}]$  oraliqlarda bajarilishini ko'rsatadi. Yechim ushbu oraliqlar birlashmasidan iborat:

$$\left(\frac{2\pi}{5} + 2k\pi; \frac{4\pi}{5} + 2k\pi\right) \cup \left(\frac{6\pi}{5} + 2k\pi; \frac{8\pi}{5} + 2k\pi\right), k \in Z.$$

2 - misol.  $f(\alpha) = \operatorname{tg} \alpha - \operatorname{tg} \frac{\alpha}{3} > 0$  tengsizligini yechamiz.

Yechish. 1)  $\operatorname{tg} \alpha$  ning davri  $T_1 = \pi$ ,  $\operatorname{tg} \frac{\alpha}{3}$  ning davri  $T_2 = 3\pi$ .

$T_1$  va  $T_2$  ning eng kichik umumiy bo'linuvchisi, ya'ni  $f$  ning asosiy davri  $T_0 = 3\pi$ . Tengsizlikning  $[0; 3\pi]$  oraliqdagi yechimini topish yetarli. Qolganlari son o'qida  $3\pi$  davr bilan takrorlanadi;

2)  $\operatorname{tg} \alpha - \operatorname{tg} \frac{\alpha}{3} = 0$  tenglamaning ildizlari:  $\alpha = 3\pi k, k \in Z$ . Ulardan  $[0; 3\pi]$  oraliqda yotgani 0 va  $3\pi$ ;

3)  $f$  funksiya  $\cos \alpha = 0$  va  $\cos \frac{\alpha}{3} = 0$  da, ya'ni  $\alpha = \frac{\pi}{2} + \pi k, k \in Z$  nuqtalarda uzilishga ega. Shu jumladan  $\frac{\pi}{2}, \frac{3\pi}{2}, \frac{5\pi}{2}$  nuqtalar qaralayotgan  $[0; 3\pi]$  oraliqda joylashgan;

4) topilgan nuqtalar  $[0; 3\pi]$  oraliqni  $[0; \frac{\pi}{2}]$ ,  $[\frac{\pi}{2}; \frac{3\pi}{2}]$ ,  $[\frac{3\pi}{2}; \frac{5\pi}{2}]$ ,  $[\frac{5\pi}{2}; 3\pi]$  qismlarga ajratadi;

5) sinash nuqtalari yordamida berilgan tengsizlik yechimi ushbu intervallardan tuzilganligini aniqlaymiz:

$$\left(3\pi k; \frac{\pi}{2} + 3\pi k\right), \left(\frac{3\pi}{2} + 3\pi k; \frac{5\pi}{2} + 3\pi k\right), k \in Z.$$

$f$  – toq funksiya. Shunga ko‘ra hisoblashlarni  $[0; 3\pi]$  da emas, balki  $\left[-\frac{3\pi}{2}; \frac{3\pi}{2}\right]$  da bajarish ma’qul. Haqiqatan,  $f'(\alpha) > 0$  tengsizlik  $\left[0; \frac{\pi}{2}\right]$  da bajarilsa,  $\left[-\frac{\pi}{2}; 0\right]$  da  $f(\alpha) < 0$  tengsizlik bajariladi.

Yechish:  $\left(-\frac{3\pi}{2} + 3\pi k; -\frac{\pi}{2} + 3\pi k\right), \left(3\pi k; \frac{\pi}{2} + 3\pi k\right), k \in Z$ .

## Mashqlar

1.152. Tengsizliklarni yeching:

- 1)  $\sin 3x < -\cos 3x$ ;    2)  $\sin 3x < \cos 3x$ ;    3)  $\sin 3x \cos 3x > 0$ ;  
 4)  $\cos 3x \operatorname{tg} 3x > 0$ ;    5)  $\sin 2x + \operatorname{tg} 2x < 0$ ;    6)  $\operatorname{tg} 2x > \sqrt{3}$ ;  
 7)  $\operatorname{ctg} \frac{2\pi x}{3(x-2)} < 1$ ;    8)  $\cos x \cos 3x < \cos 2x \cos 4x$ ;  
 9)  $\sin^4 x - \cos^4 x < \frac{1}{2}$ ;    10)  $(1 - \operatorname{ctg} x) \sin^2 x > 1$ ;  
 11)  $3\sin 2x - 1 > \sin x + \cos x$ .

11. Trigonometrik funksiya qiymatini taqribiy hisoblash.

$0 < x < \frac{\pi}{2}$  da  $\sin x < x < \operatorname{tg} x$  bo‘lishini bilamiz. Ikkinchi tomondan  $\sin \frac{x}{2} = \sqrt{\frac{1 - \cos x}{2}}$  ekanligidan  $\cos x = 1 - 2 \sin^2 \frac{x}{2} > 1 - 2 \cdot \left(\frac{x}{2}\right)^2 = 1 - \frac{x^2}{2}$  ni olamiz. Bu tengsizlik va  $\operatorname{tg} x = \frac{\sin x}{\cos x}$  munosabatdan foydalanib, ixchamlashtirishlardan so‘ng ushbu qo‘sh tengsizlik hosil bo‘ladi:

$$x - \frac{x^3}{2} < \sin x < x < \operatorname{tg} x. \quad (1)$$

1 - misol.  $\sin 0,05$  qiymatini 0,01 gacha aniqlikda topamiz.

Yechish. (1) bo‘yicha:

$$0,05 - \frac{0,000125}{2} < \sin 0,05 < 0,05; \quad 0,0499 < \sin 0,05 < 0,05,$$

bundan  $\sin 0,05 \approx \frac{0,05 + 0,0499}{2} = 0,050$ .

Yuqori aniqlik talab qilingan hollarda ushbu formulalardan foydalanish mumkin (isboti oliy matematika kursida o‘rganiladi):

$$\sin x = x - \frac{x^3}{3!} + \frac{x^5}{5!} - \dots; \quad (2)$$

$$\cos x = 1 - \frac{x^2}{2!} + \frac{x^4}{4!} - \dots \quad (3)$$

2 - misol. a)  $\sin 0,15$ ; b)  $\cos 0,15$  ni  $10^{-4}$  gacha aniqlikda topamiz.

Yechish. Talab etilayotgan aniqlikka erishish uchun (2) va (3) formulalarni qanday darajali hadgacha olishni bilish kerak:

$$\frac{0,15^3}{3!} = 0,00056 > 0,0001, \quad \frac{0,15^4}{4!} = 0,000021 < 0,001.$$

Demak, (2) formula beshinchi darajali hadgacha, (3) formula esa to'rtinchi darajali hadgacha olinishi yetarli. Hisoblashlarga o'tamiz:

$$a) \sin 0,15 \approx 0,15 - \frac{0,15^3}{3!} + \frac{0,15^5}{5!} \approx 0,14948;$$

$$b) \cos 0,15 \approx 1 - \frac{0,15^2}{2!} + \frac{0,15^4}{4!} \approx 0,98876.$$



### Mashqlar

**1.153.** Ifodaning qiymatini 0,0001 gacha aniqlikda toping:

- 1)  $\sin 0,24$ ;                      2)  $\cos 0,18$ ;                      3)  $\operatorname{tg} 0,15$ ;  
4)  $\sin 31^\circ$ ;                      5)  $\cos 23^\circ$ ;                      6)  $\operatorname{tg} 16^\circ$ .

## 5-§. Teskari trigonometrik funksiyalar

**1. Arkfunksiyalar va ularning asosiy xossalari.** Ushbu

$$y = \sin x, \quad -\frac{\pi}{2} \leq x \leq \frac{\pi}{2} \quad (1)$$

funksiyani qaraymiz.

$x$  argumentning qiymatlari  $-\frac{\pi}{2}$  dan  $\frac{\pi}{2}$  gacha o'sib borganda  $y$  ning qiymatlari  $-1$  dan  $1$  gacha o'sib borishi va  $[-1; 1]$  kesmani to'ldirishi bizga ma'lum (I.31-rasm). Bu yerdan,  $y$  ning  $[-1; 1]$  kesmadagi har bir qiymatiga  $\sin x = y$ ,  $-\frac{\pi}{2} \leq x \leq \frac{\pi}{2}$  shartlarni qanoatlantiruvchi birgina  $x$  sonni, ya'ni  $x = \arcsin y$  sonni mos qo'yish mumkinligi kelib chiqadi.

Har bir  $y \in [-1; 1]$  songa uning arksinusini mos qo'yib, quyidagi funksiyaga ega bo'lamiz:

$$x = \arcsin y, \quad -1 \leq y \leq 1. \quad (2)$$

$x$  va  $y$  o'zgaruvchilarning (1) shartni qanoatlantiruvchi har qanday qiymatlari jufti (2) shartni ham qanoatlantiradi va aksincha, shu juftlik uchun (2) shart bajarilsa, u holda  $x$  va  $y$  uchun (1) shart ham bajariladi (isbotlang). Demak, (1) va (2) funksiyalar o'zaro teskari funksiyalardir.

Odatda funksiyaning argumenti  $x$  bilan, funksiyaning o'zi esa  $y$  bilan belgilangani uchun (2) da  $x$  ni  $y$  bilan,  $y$  ni esa  $x$  bilan almashtirib, quyidagi funksiyaga ega bo'lamiz:

$$y = \arcsin x, \quad -1 \leq x \leq 1. \quad (3)$$

$y = \arcsin x$  funksiya  $y = \sin x$ ,  $x \in \left[-\frac{\pi}{2}; \frac{\pi}{2}\right]$  funksiyaga teskari funksiya bo'lgani uchun uning ayrim xossalari  $y = \sin x$ ,  $x \in \left[-\frac{\pi}{2}; \frac{\pi}{2}\right]$  funksiyaning xossalariidan hosil qilish mumkin.

1°.  $y = \arcsin x$  funksiyaning aniqlanish sohasi  $[-1; 1]$  kesmadan iborat, chunki  $y = \sin x$  funksiyaning qiymatlari sohasi  $[-1; 1]$  kesmadan iborat.

2°.  $y = \arcsin x$  funksiyaning qiymatlari sohasi  $\left[-\frac{\pi}{2}; \frac{\pi}{2}\right]$  kesmadan iborat, chunki  $y = \sin x$ ,  $-\frac{\pi}{2} \leq x \leq \frac{\pi}{2}$  funksiyaning aniqlanish sohasi  $\left[-\frac{\pi}{2}; \frac{\pi}{2}\right]$  kesmadan iborat.

Eslatma.  $y = \sin x$  funksiya  $(-\infty; +\infty)$  oraliqda teskarilanuvchi emas, chunki har qanday  $y \in [-1; 1]$  songa  $\sin x = y$  shartni qanoatlantiruvchi cheksiz ko'p  $x \in (-\infty; +\infty)$  sonlar mos keladi.  $y = \sin x$  funksiyaning teskarilanuvchi bo'lishligini ta'minlash uchun uning aniqlanish sohasi sun'iy ravishda toraytiriladi va aniqlanish sohasi sifatida  $\left[-\frac{\pi}{2}; \frac{\pi}{2}\right]$  kesma olinadi.

3°.  $y = \arcsin x$  funksiya  $[-1; 1]$  kesmada o'sadi, chunki  $y = \sin x$  funksiya  $\left[-\frac{\pi}{2}; \frac{\pi}{2}\right]$  kesmada o'suvchi funksiya.

4°.  $y = \arcsin x$  funksiya toq funksiya, ya'ni  $\arcsin(-x) = -\arcsin x$  tenglik barcha  $x \in [-1; 1]$  lar uchun o'rinli (qarang, 4- § ning 1-bandi).

5°.  $y = \arcsin x$  funksiya davriy funksiya emas.

Haqiqatan ham,  $y = \arcsin x$  funksiya davriy funksiya va  $T \neq 0$  son  $y = \arcsin x$  funksiyaning biror davri, ya'ni barcha  $x \in [-1; 1]$

lar uchun  $\arcsin(x + T) = \arcsin x$  tenglik bajariladi deb faraz qilaylik. U holda bu tenglikdan  $x = 0 \in [-1; 1]$  da  $\arcsin T = 0$  ga ega bo'lamiz. Demak,  $T = 0$ . Bu esa  $T \neq 0$  ekanligiga zid. Shunday qilib  $y = \arcsin x$  funktsiya davriy funktsiya emas.

$y = \arcsin x$  funktsiya  $y = \sin x$ ,  $-\frac{\pi}{2} \leq x \leq \frac{\pi}{2}$  funktsiyaga teskari funktsiya bo'lgani uchun, uning grafigini  $y = \sin x$ ,  $-\frac{\pi}{2} \leq x \leq \frac{\pi}{2}$  funktsiya grafigini  $y = x$  to'g'ri chiziqqa nisbatan simmetrik almash-tirish bilan hosil qilish mumkin (1.49-a rasm).

### Tarixiy ma'lumot

Mirzo Ulug'bek o'zining «Zij» asarida sinusni *jayb*,  $1 - \cos x$  r *sahm* ( $x$ ), arksinusni esa *jaybi ma'kus* (teskari sinus) deb atagar. Bu funktsiyalarni doiraviy segmentda tasvirlagan (1.49-b rasm: hozirgi yozuvlar bizniki) va ularning ayrim xossalari foydalangan.

$y = \cos x$ ,  $0 \leq x \leq \pi$  funktsiya teskarilanuvchi va unga teskari funktsiya  $y = \arccos x$ ,  $-1 \leq x \leq 1$  funktsiyadan iborat ekanligi xuddi yuqoridagi kabi mulohazalar yuritib hosil qilinadi.

$y = \arccos x$  funktsiyaning asosiy xossalari keltiramiz:

1°.  $y = \arccos x$  funktsiyaning aniqlanish sohasi  $[-1; 1]$  kesmadan iborat.

2°.  $y = \arccos x$  funktsiyaning qiymatlari sohasi  $[0; \pi]$  kesmadan iborat.

3°.  $y = \arccos x$  funktsiya  $[-1; 1]$  kesmada kamayadi.

4°.  $y = \arccos x$  funktsiya juft funktsiya ham emas, toq funktsiya ham emas (4-§, 2-band.).

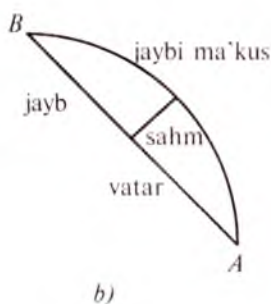
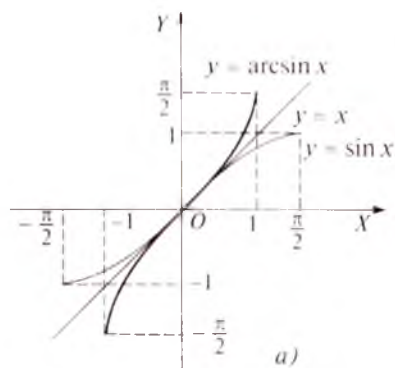

1.49-rasm.

5°.  $y = \arccos x$  funksiya davriy emas.

$y = \arccos x$  funksiyaning grafigi  $y = \cos x$ ,  $0 \leq x \leq \pi$  funksiya grafigini  $y = x$  to'g'ri chiziqqa nisbatan simmetrik almashtirish bilan hosil qilinadi (I.50-rasm).

$y = \arcsin x$  va  $y = \arccos x$  funksiyalarning asosiy xossalarini jadvalda keltiramiz:

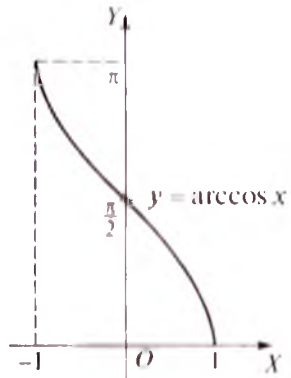

I.50-rasm.

Xossalar	Funksiya	
	$y = \arcsin x$	$y = \arccos x$
Aniqlanish sohasi	$[-1; 1]$	$[-1; 1]$
Qiymatlar sohasi	$[-\frac{\pi}{2}; \frac{\pi}{2}]$	$[0; \pi]$
Monotonligi	$[-1; 1]$ oraliqda o'suvchi	$[-1; 1]$ oraliqda kamayuvchi
Juft-toqligi	toq funksiya	juft emas, toq emas
Davriyligi	davriy emas	davriy emas

$y = \arctg x$ ,  $x \in R$  funksiya  $y = tgx$ ,  $-\frac{\pi}{2} < x < \frac{\pi}{2}$  funksiya,  $y = \arctg x$ ,  $x \in R$  funksiya esa  $y = ctgx$ ,  $0 < x < \pi$  funksiya teskari funksiyadir. Ularning asosiy xossalarini jadval ko'rinishida keltiramiz:

Xossalar	Funksiya	
	$y = \arctg x$	$y = \arctg x$
Aniqlanish sohasi	$(-\infty; +\infty)$	$(-\infty; +\infty)$
Qiymatlar sohasi	$(-\frac{\pi}{2}; \frac{\pi}{2})$	$(0; \pi)$
Monotonligi	$(-\infty; +\infty)$ oraliqda o'suvchi	$(-\infty; +\infty)$ oraliqda kamayuvchi
Juft-toqligi	toq funksiya	juft emas, toq emas
Davriyligi	davriy emas	davriy emas



$y = \text{arctg}x$  va  $y = \text{arcctg}x$  funksiyalarning grafiklari mos ravishda I.51-rasm va I.52-rasmlarda tasvirlangan.

$y = \arcsin x$ ,  $y = \arccos x$ ,  $y = \text{arctg}x$  va  $y = \text{arcctg}x$  funksiyalar *teskari trigonometrik funksiyalar* deb ataladi. Boshqa funksiyalar kabi, bu funksiyalarning ham ba'zi nuqtalardagi aniq qiymatlarini, masalan,  $\arcsin 1 = \frac{\pi}{2}$ ,  $\arccos 1 = 0$ ,  $\text{arctg} \frac{\sqrt{2}}{2} = \frac{\pi}{4}$ ,  $\text{arcctg} \sqrt{3} = \frac{\pi}{6}$  ekanligini ko'rsatish mumkin. Umumiy holda esa turli hisoblash vositalari (grafiklar, jadvallar, kalkulatorlar va h.k.) yordamida bu funksiyalarning taqribiy qiymatlari kerakli aniqlikda hisoblanadi.

1 - misol. Kalkulator yordamida  $\arcsin 0,5773 \approx 0,615$ ,  $\arccos 0,5773 \approx 0,836$  ekanligini topish mumkin.

2 - misol.  $y = \arcsin(x^2 + 1)$  funksiyaning aniqlanish sohasini va qiymatlari sohasini topamiz.

**Yechish.**  $y = \arcsin x$  funksiyaning aniqlanish sohasi  $[-1; 1]$  kesmadan iborat. Shu sababli,  $y = \arcsin(x^2 + 1)$  funksiya  $x$  ning  $-1 \leq x^2 + 1 \leq 1$  shart bajariladigan barcha qiymatlaridagina aniqlangandir.  $-1 \leq x^2 + 1 \leq 1$  tengsizlik  $x = 0$  bo'lganda va faqat shu holda bajariladi.

$x = 0$  bo'lganda,  $y(0) = \arcsin(0^2 + 1) = \arcsin 1 = \frac{\pi}{2}$ . Shunday qilib, berilgan funksiyaning aniqlanish sohasi  $\{0\}$  to'plamdan, qiymatlar sohasi esa  $\{\frac{\pi}{2}\}$  to'plamdan iborat.

3 - misol.  $y = \frac{\arccos(x^2 + 1)}{x}$  funksiyaning aniqlanish sohasi va qiymatlari sohasini topamiz.

**Yechish.** Bu funksiya  $x$  ning  $x \neq 0$  va  $-1 \leq x^2 + 1 \leq 1$  shartlarni qanoatlantiradigan barcha qiymatlaridagina aniqlangan.

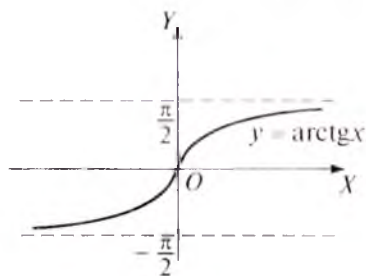

I.51-rasm.

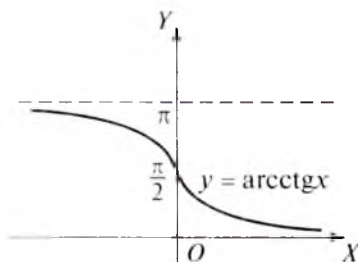

I.52-rasm.

$x$  ning  $x \neq 0$ ,  $-1 \leq x^2 + 1 \leq 1$  shartlar bir vaqtda o'rinli bo'ladigan qiymati mavjud emas. Shunday qilib, berilgan funksiyaning aniqlanish sohasi, shuningdek, qiymatlar sohasi ham bo'sh to'plamdir.

4 - misol.  $y = \arcsin x$ ,  $-\frac{1}{2} \leq x < 0$  funksiyaning aniqlanish sohasini va qiymatlar sohasini topamiz.

Yechish. Funksiyaning berilishidan ko'rinadiki, uning aniqlanish sohasi  $(-\frac{1}{2}; 0]$  oraliqdan, qiymatlar sohasi esa  $y = \arcsin x$  funksiya  $[-1; 1]$  kesmada o'suvchi va  $y(-\frac{1}{2}) = -\frac{\pi}{6}$ ,  $y(0) = 0$  bo'lgani uchun  $[-\frac{\pi}{6}; 0)$  oraliqdan iborat bo'ladi.



## Mashqlar

1.154. a) Quyidagi funksiyaning aniqlanish sohasini toping:

1)  $y = \arcsin(x + 1)$ ;    2)  $y = \arccos \frac{1+4x}{3}$ ;    3)  $y = \arccos \frac{x-5}{7}$ .

b)  $y = \operatorname{arctg}^2 x - 3$  funksiya son o'qi bo'yicha chegaralanganmi?

d)  $y = 1 - \cos x$  (sahm)ga teskari funksiyani ta'riflang, ifodasini yozing, aniqlanish va o'zgarish sohalarini toping, monotonlikka tekshiring, grafisini yasang.

1.155. Jadvaldagi bo'sh kataklarni to'ldiring (hisoblashlarni EHM yoki mikrokalkulordan foydalanib bajaring):

$x$	0,7				
$\arcsin x$		0,85 (rad)			
$\arccos x$			0,9 (rad)		
$\operatorname{arctg} x$				$-\pi/6$ (rad)	
$\operatorname{arctg} x$					0,3

2. Arkfunksiyalar qatnashgan ayrim ayniyatlar. Teskari trigonometrik funksiyalarga berilgan ta'riflarga ko'ra, masalan,  $y = \sin x$ ,  $-\frac{\pi}{2} \leq x \leq \frac{\pi}{2}$  va  $x = \arcsin y$ ,  $-1 \leq y \leq 1$  bir ma'noli munosabatlardir. Agar  $y = \sin x$  tenglikda  $x$  o'rniga  $\arcsin y$  qo'yilsa, ushbu ayniyat hosil bo'ladi:

$$\sin(\arcsin y) = y, \quad -1 \leq y \leq 1. \quad (1)$$

Shu tariqa quyidagi ayniyatlarni ham olish mumkin:

$$\cos(\arccos y) = y, \quad -1 \leq y \leq 1, \quad (2)$$

$$\operatorname{tg}(\operatorname{arctg} y) = y, \quad -\infty < y < +\infty, \quad (3)$$

$$\operatorname{ctg}(\operatorname{arcctg} y) = y, \quad -\infty < y < +\infty. \quad (4)$$

Agar  $x = \arcsin y$  tenglikda  $y$  o'rniga  $\sin x$  qo'yilsa:

$$\arcsin(\sin x) = x, \quad -\frac{\pi}{2} \leq x \leq \frac{\pi}{2}. \quad (5)$$

Shu kabi:

$$\arccos(\cos x) = x, \quad 0 \leq x \leq \pi, \quad (6)$$

$$\operatorname{arctg}(\operatorname{tg} x) = x, \quad -\frac{\pi}{2} < x < \frac{\pi}{2}, \quad (7)$$

$$\operatorname{arcctg}(\operatorname{ctg} x) = x, \quad 0 < x < \pi. \quad (8)$$

1 - m i s o l.  $\arcsin x + \arccos x = \frac{\pi}{2}$  (bu yerda,  $|x| \leq 1$ ) ayniyatni isbot qilamiz.

I s b o t.  $|x| \leq 1$  bo'lsin. U holda  $\arcsin x$  va  $\frac{\pi}{2} - \arccos x$  ifodalar ma'noga ega.  $\arcsin x$ ,  $\frac{\pi}{2} - \arccos x$  sonlarining har biri  $y = \arcsin x$  funksiyaning o'sish oraliqlaridan biriga, xususan,  $\left[-\frac{\pi}{2}; \frac{\pi}{2}\right]$  oraliqqa tegishli va  $\sin(\arcsin x) = x$ ,  $\sin\left(\frac{\pi}{2} - \arccos x\right) = x$  tengliklar o'rinli. Shu sababli  $\arcsin x = \frac{\pi}{2} - \arccos x$ .

2 - m i s o l.  $\arcsin(\sin x)$  ifodani hisoblaymiz.

Y e c h i s h. Har qanday  $x \in \mathbb{R}$  son uchun  $\sin x \in [-1; 1]$  bo'lgani sababli  $\arcsin(\sin x)$  ifoda barcha  $x \in \mathbb{R}$  sonlar uchun ma'noga ega va  $\arcsin a$  ning ta'rifiga ko'ra,  $\arcsin(\sin x) \in \left[-\frac{\pi}{2}; \frac{\pi}{2}\right]$ .

$\arcsin(\sin x) = y$  bo'lsin. U holda  $\sin y = \sin x$ ,  $y \in \left[-\frac{\pi}{2}; \frac{\pi}{2}\right]$  shartlar bajariladi.  $\sin y = \sin x$  bo'lgani uchun,  $x = (-1)^k y + k\pi$  yoki  $y = \frac{x - k\pi}{(-1)^k} = \frac{(-1)(k\pi - x)}{(-1)^k} = (-1)^{1-k} (k\pi - x)$  (bu yerda  $k \in \mathbb{Z}$ )

bo'ladi. Bu yerdan ko'rinadiki,  $|y| \leq \frac{\pi}{2}$  bo'lishi uchun  $|k\pi - x| \leq \frac{\pi}{2}$  bo'lishi yetarlidir.

Shunday qilib,  $\arcsin(\sin x) = (-1)^{1-k}(k - \pi)$ , bu yerda  $k$  son

$|k\pi - x| \leq \frac{\pi}{2}$  tengsizlikni qanoatlantiradigan butun son.



## Mashqlar

**1.156.** Ayniyatni isbotlang:

1)  $\cos(\arcsin x) = \sqrt{1-x^2}$  ;

2)  $\arccos x = \operatorname{arctg} \frac{x}{\sqrt{1-x^2}}$  ,  $-1 < x < 1$  ;

3)  $\operatorname{arctg} x = \arccos \frac{x}{\sqrt{1+x^2}}$  ;

4)  $\operatorname{arctg} x = \arcsin \frac{x}{\sqrt{1+x^2}}$  ,  $-\infty < x < +\infty$  ;

5)  $2 \arcsin x = \arcsin \left( 2x\sqrt{1-x^2} \right)$  ,  $0 \leq x \leq \frac{\pi}{2}$  ;

6)  $\operatorname{arctg}(\operatorname{tg} x) = x - k\pi$  ,  $\pi - \frac{\pi}{2} < x < k\pi + \frac{\pi}{2}$  ;

7)  $\cos(\operatorname{arctg} x) = \frac{1}{\sqrt{1+x^2}}$  ; 8)  $\sin(\operatorname{arctg} x) = \frac{x}{\sqrt{1+x^2}}$  .

**1.157.** Ifodaning qiymatini toping:

1)  $\operatorname{arctg}(\operatorname{tg} 3)$ ;

2)  $\arcsin(\sin 4)$ ;

3)  $\arccos\left(\cos \frac{\pi}{3}\right)$ ;

4)  $\operatorname{arctg}\left(\operatorname{ctg} \frac{\pi}{6}\right)$ ;

5)  $\arccos\left[\sin\left(-\frac{\pi}{8}\right)\right]$ ;

6)  $\arcsin\left(\cos \frac{30}{7}\pi\right)$ ;

7)  $\operatorname{arctg}\left(\operatorname{ctg} \frac{3\pi}{7}\right)$ ;

8)  $2\left[\arcsin\left(-\frac{\sqrt{3}}{2}\right)\right] + 3\arccos\left(-\frac{1}{2}\right) - \operatorname{arctg} 1$  ;

9)  $\cos(2\arccos x)$ ;

10)  $\cos(3\arccos x)$ ;

11)  $\cos\left(\operatorname{arctg}\left(-\frac{5}{24}\right)\right)$ ;

12)  $\arcsin(\sin 100)$ ;

13)  $\sin(3 \arcsin x)$ .

**3. Teskari trigonometrik funksiyalar qatnashgan tenglamalar va tengsizliklar.** Teskari trigonometrik funksiyalar qatnashgan tenglamalarni yechishda teng argumentlarda bir xil ismli trigonometrik funksiyalarning qiymatlari ham teng bo'lishidan, ya'ni

trigonometrik funksiyalarning bir qiymatlilik xossasidan foydalaniladi.

Ko'pchilik hollarda arksinoidal funksiyalar ko'rinishida berilgan teng argumentlarning bir xil ismli trigonometrik funksiyalarini tenglashtirib, berilgan tenglamaga nisbatan soddaroq tenglama (masalan, algebraik tenglama) hosil qilish mumkin bo'ladi. Hosil qilingan tenglama berilgan tenglamaga umuman olganda teng kuchli emas, chunki bir xil ismli trigonometrik funksiya qiymatlarining tengligidan shu funksiya argumentlarining tengligi kelib chiqmaydi.

1 - misol.  $\arcsin \frac{3}{5}x + \arcsin \frac{4}{5}x = \arcsin x$  tenglamani yechamiz.

Yechish. Tenglamaning aniqlanish sohasi  $x$  ning  $|\frac{3}{5}x| \leq 1$ ,  $|\frac{4}{5}x| \leq 1$ ,  $|x| \leq 1$  tengsizliklar bir vaqtda bajariladigan qiymatlari to'plami  $\{x: |x| \leq 1\}$  dan iborat.

Berilgan tenglama chap va o'ng tomonlarining sinuslarini tenglashtiramiz:

$$\sin\left(\arcsin \frac{3}{5}x + \arcsin \frac{4}{5}x\right) = \sin(\arcsin x).$$

Yig'indining sinusi formulasidan va  $\sin(\arcsin \alpha) = \alpha$ ,  $\cos(\arcsin \alpha) = \sqrt{1 - \alpha^2}$  (bu yerda  $|\alpha| \leq 1$ ) ayniyatlardan foydalanib,

$$\frac{3}{5}x \cdot \sqrt{1 - \frac{16}{25}x^2} + \frac{4}{5}x \cdot \sqrt{1 - \frac{9}{25}x^2} = x.$$

tenglamaga ega bo'lamiz. Bu tenglama  $x_1 = 0$ ,  $x_{2,3} = \pm 1$  ildizlarga ega. Ularning har birini tenglamaga bevosita qo'yib ko'rib, bu ildizlar tenglamani qanoatlantirishini ko'ramiz. Masalan,  $x = 1$  uchun

$$\arcsin \frac{3}{5} + \arcsin \frac{4}{5} = \arcsin \frac{3}{5} + \arccos \frac{3}{5} = \frac{\pi}{2}.$$

2 - misol.  $(\arcsin x)^3 + (\arccos x)^3 = \pi^3$  tenglamani yechamiz.

Yechish.  $a^3 + b^3 = (a + b)^3 - 3ab(a + b)$  ayniyatdan foydalanib va  $\arcsin x + \arccos x = \frac{\pi}{2}$  ekanligini nazarda tutib, quyidagi tenglamaga ega bo'lamiz:

$$\left(\frac{\pi}{2}\right)^3 - 3 \cdot \frac{\pi}{2} \cdot \arcsin x \cdot \arccos x = \pi^3$$

yoki

$$\arcsin x \cdot \arccos x = -\frac{7}{12} \pi^2.$$

$y = \arccos x$ , ( $|y| \leq \frac{\pi}{2}$ ) desak,  $y^2 - \frac{\pi}{2}y - \frac{7\pi^2}{12} = 0$  kvadrat tenglama hosil bo'ladi. Bu kvadrat tenglamaning ildizlari absolut qiymati jihatidan  $\frac{\pi}{2}$  dan katta bo'lgani uchun berilgan tenglama yechimga ega emas.

3 - misol.  $2\arcsin^2x - 5\arcsinx + 2 = 0$  tenglamani yechamiz.

Yechish.  $\arcsinx = z$  almashtirish berilgan tenglamani  $2z^2 - 5z + 2 = 0$  kvadrat tenglamaga keltiradi. Uning ildizlari  $z_1 = 0,5$ ,  $z_2 = 2$ . Lekin  $z_2$  ildiz  $-\frac{\pi}{2} \leq \arcsin x \leq \frac{\pi}{2}$  bo'lish shartini qanoatlantirmaydi.  $z_1$  ildiz bo'yicha  $\arcsin x = \frac{1}{2}$  tenglamani tuzamiz. Bu tenglamaning yechimi  $x = \sin 0,5$ .

Endi arkfunksiyalar qatnashgan tengsizliklarga doir misollar qaraymiz.

4 - misol.  $\arctg^2x - 4\arctgx + 3 > 0$  tengsizlikni yechamiz.

Yechish.  $\arctgx = y$  deb olsak, berilgan tengsizlik quyidagi ko'rinishni oladi:

$$y^2 - 4y + 3 > 0.$$

Bu tengsizlik  $y < 1$  yoki  $y > 3$  bo'lganda bajariladi. Eski o'zgaruvchiga qaytib,  $\arctgx < 1$  va  $\arctgx > 3$  tengsizliklarga ega bo'lamiz.  $\arctgx < 1$  tengsizlik  $x \in (-\infty; \operatorname{tg} 1)$  yechimlarga,  $\arctgx > 3$  tengsizlik esa  $x \in (\operatorname{tg} 3; +\infty)$  yechimlarga ega.

Javob:  $(-\infty; \operatorname{tg} 1) \cup (\operatorname{tg} 3; +\infty)$ .

5 - misol.  $\arcsinx > \arccosx$  tengsizlikni yeching.

Yechish. Tengsizlikning aniqlanish sohasi  $[-1; 1]$  kesmadan iborat.

$x < 0$  bo'lganda  $\arcsinx < 0$ ,  $\arccosx > 0$  bo'lgani uchun berilgan tengsizlik manfiy yechimlarga ega emas.  $0 \leq x \leq 1$  bo'lsin.

U holda  $\arcsin x \in \left[0; \frac{\pi}{2}\right]$  va  $\arccos x \in \left[0; \frac{\pi}{2}\right]$  bo'ladi.  $\left[0; \frac{\pi}{2}\right]$  oraliqda  $\sin x$  funksiya o'suvchi bo'lgani uchun,  $x \in [0; 1]$  bo'l-

ganda berilgan tengsizlik  $\sin(\arcsin x) > \sin(\arccos x)$  tengsizlikka teng kuchlidir. Bu yerdan  $x > \sqrt{1-x^2}$  tengsizlikni hosil qilamiz.  $x > \sqrt{1-x^2}$  tengsizlikni  $[0; 1]$  oraliqda yechib,  $x \in \left(\frac{\sqrt{2}}{2}; 1\right]$  mi olamiz.



## Mashqlar

**1.158.** Tenglamani yeching:

1)  $\arcsin^2 x - \frac{3\pi}{2} \arcsin x + \frac{5\pi^2}{4} = 0;$

2)  $\arccos^2 x - \frac{2\pi}{3} \arccos x + \frac{\pi^2}{12} = 0;$

3)  $\operatorname{arctg}^2 x - \frac{7\pi}{12} \operatorname{arctg} x + \frac{\pi^2}{12} = 0;$

4)  $\arcsin\left(x^2 - 5x + \frac{7}{4}\right) = -\frac{\pi}{6};$

5)  $\arcsin\left(x^2 - 3x + \frac{\pi}{4}\right) = \frac{\pi}{2};$

6)  $\arcsin x + \arcsin x\sqrt{3} = \frac{\pi}{2};$

7)  $\sin(2\arcsin x) + \cos(2\arcsin x) = 1;$

8)  $\sin\left(\frac{1}{5} \arccos x\right) = 1.$

**1.159.** Tengsizlikni yeching:

1)  $-\frac{\pi}{4} \leq \arcsin(x^2 - 4) \leq \frac{\pi}{3};$

2)  $\frac{5}{4} \leq \operatorname{arctg}^2 3x - 2\operatorname{arctg} 3x \leq 3;$

3)  $\arccos x < \arcsin x;$

4)  $\operatorname{arctg} x < \operatorname{arccotg} x.$

**1.160.** 1) Agar:

$$\operatorname{tg} \alpha = \frac{5+\sqrt{x}}{2}, \operatorname{tg} \beta = \frac{5-\sqrt{x}}{2}, \alpha + \beta = 45^\circ$$

bo'lsa,  $x$  ni toping;

2)  $ABC$  uchburchakda:

$$\angle A = \alpha, \angle B = \beta, \angle C = \gamma, \alpha : \beta : \gamma = 1 : 2 : 3, BC = 2\sqrt{3}$$

bo'lsa, uning perimetrini toping.

## 1 bob bo'yicha topshiriq

1-6- topshiriqlar hamma uchun, 7-8- topshiriqlar variantlar bo'yicha bajariladi. Hisoblashlarda EHM, mikrokalkulator va jadvaldan foydalanish ma'qul.

Topshiriqning mazmuni. Jism  $O$  nuqtadan (I.53-rasm) gorizontga nisbatan  $\alpha$  burchak ostida  $v_0$  boshlang'ich tezlik bilan otilgan. Tashqi kuchlar ta'sir etmaganda u  $s = v_0 t$  to'g'ri chiziqli tekis harakat qilgan va  $t$  vaqtdan so'ng biror  $B(x, y')$  nuqtaga kelgan bo'lar edi, nuqta koordinatalari  $x = v_0 t \cos \alpha$ ,  $y' = v_0 t \sin \alpha$ . Lekin jism Yerning tortish kuchi ta'siri ostida harakat chizig'idan chetga chiqadi va  $t$  vaqtdan so'ng  $\frac{gt^2}{2}$  qadar quyida joylashgan  $A(x, y)$  nuqtaga keladi (havo qarshiligi hisobga olinmagan holda):

$$x = v_0 t \cos \alpha; \quad (1)$$

$$y = v_0 t \sin \alpha - \frac{gt^2}{2}. \quad (2)$$

Qolgan vaqt momentlarida ham harakat shu tarzda davom etadi.

(2) munosabat bosh had koeffitsiyenti ishorasi manfiy, ozod hadi nolga teng bo'lgan kvadrat uchhad. Demak, jism parabolik trayektoriya bo'yicha harakat qiladi.

Shu kabi,  $v_0$  boshlang'ich tezlikning tashkil etuvchilari  $v_x = v_0 \cos \alpha$ ,  $v_y = v_0 t \sin \alpha$ . Lekin gravitatsiya ta'siri ostida jismning  $t$  vaqt paytidagi  $v$  tezligi

$$v_x = v_0 \cos \alpha, \quad (3)$$

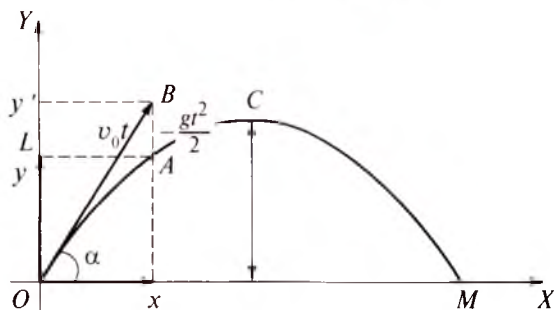

I.53-rasm.



$$v_y = v_0 \sin \alpha - gt \quad (4)$$

tashkil etuvchilarga (koordinata o'qlaridagi proeksiyalarga) ega bo'ladi.

Toping:

- 1) jismning  $t$  vaqt momentidagi  $v$  tezligi;
- 2) jismning  $y = f(x)$  ko'rinishdagi harakat tenglamasi;
- 3) qancha vaqtdan so'ng jismning eng yuqoriga ( $C$  nuqta) ko'tarilishi,  $t = t_C$ ;
- 4) eng yuqori qanday balandlikkacha ko'tarilishi ( $y_C$ );
- 5) jism borib tushadigan masofa ( $x_M$ );
- 6) jism eng uzoqqa borib tushishi uchun u  $O$  nuqtadan gorizontga nisbatan qanday  $\alpha$  burchak ostida otilishi kerakligi;
- 7)  $v_0 = 10$  km/s tezlik va gorizontga nisbatan  $\alpha = 10^\circ + 5^\circ k$ ,  $k = \overline{0; 30}$  burchak ostida otilgan jism qanday balandlikkacha ko'tariladi va qanday masofaga borib tushadi?
- 8) qanday  $\alpha$  burchak ostida otilgan jism  $s = 1 + 0,1k$  (km),  $k = \overline{0; 30}$  uzoqlikka borib tushadi?
- 9) ikkinchi jism  $H = 0,5 + 0,05k$  (km) balandlikdagi  $L$  nuqtadan o'ng tomonga qarab  $y = 1 + 0,05k$  (km/s) tezlik bilan to'g'ri chiziqli tekis harakat qilib bormoqda.  $O$  nuqtadagi birinchi jism gorizontga nisbatan qanday burchak ostida otilsa, u ikkinchi jismga borib tegadi va bu qancha vaqtdan so'ng sodir boladi?  $k = \overline{0; 30}$ .

Ko'rsatma: 1)  $v = \sqrt{v_x^2 + v_y^2}$ . (3) va (4) munosabatlardan

foydalanilsa, natijada  $v = \sqrt{v_0^2 - 2g \cdot \left( v_0 t \sin \alpha - \frac{gt^2}{2} \right)}$ ;

2) (1) munosabat bo'yicha  $t = \frac{x}{v_0 \cos \alpha}$  ni topib, (2) ga qo'ysak:

$$y = x \operatorname{tg} \alpha - \frac{g}{2v_0^2 \cos^2 \alpha} \cdot x^2;$$

3) harakat boshida  $v = v_0$  bo'lgan tezlik harakat davomida kamayib borib,  $C$  nuqtada nolga teng bo'ladi:  $0 = v_0 \sin \alpha - gt$ ,

bundan  $t_C = \frac{v_0 \sin \alpha}{g}$ ;

4) (2) parabola  $C$  uchining ordinatasi ifodasidan foydalanilsa,

$$y_C = -\frac{v_0^2 \sin^2 \alpha}{4 \left( \frac{-g}{2} \right)} = \frac{v_0^2 \sin^2 \alpha}{2g};$$

5) (1) munosabat va  $t_C$  qiymatidan foydalanilsa,

$$s = (OM) = 2x_C = 2v_0 \cdot \frac{v_0 \sin^2 \alpha}{g} \cdot \cos \alpha = \frac{v_0^2 \sin 2\alpha}{g};$$

6) oldingi savol bo'yicha topilgan  $s = \frac{v_0^2 \sin 2\alpha}{g}$  munosabatga qaraganda  $s$  masofa  $\sin 2\alpha = 1$ , ya'ni  $\alpha = 45^\circ$  da eng katta qiymatga erishadi.



## II B O B

### NOSTANDART TENGLAMALAR, TENGSIZLIKLAR VA ULARNING SISTEMALARI

#### 1-§. Nostandart tenglamalar

Tashqi ko'rinishi odatdagi tenglamalardan keskin farq qiladigan tenglamalar (masalan,  $2^{|x|} = \cos x$ ,  $x^2 + 4x\cos(xy) + 4 = 0$ ), shuningdek, tashqi ko'rinishi odatdagi tenglamalarga o'xshaydigan, lekin odatdagi usullar bilan yechish mumkin bo'lmaydigan tenglamalar (masalan,  $\sin 7x + \cos 2x = -2$ ,  $\sin^4 x - \cos^7 x = 1$  va hokazo) ham uchraydi. Bunday tenglamalarni *nostandart tenglamalar* deb ataymiz.

Nostandart tenglamalarni yechishning umumiy usuli mavjud emas. Shu sababli bunday tenglamalarni yechishda funksiyalarning grafiklaridan, turli xossalaridan, tengsizliklardan va hokazolardan foydalanishga to'g'ri keladi. Buni misollarda qarab chiqamiz.

1 - m i s o l.  $2^{|x|} = \cos x$  tenglamani yechamiz.

Y e c h i s h.  $x = 0$  son tenglamani yechimi ekanini ko'ramiz (II.1-rasm).

Barcha  $x \neq 0$  sonlar uchun  $2^{|x|} > 1 \geq \cos x$  bo'lgani uchun berilgan tenglama  $x = 0$  dan boshqa yechimlarga ega emas.

2 - m i s o l.  $\sin x = x^2 + x + 1$  tenglamani yechamiz.

Y e c h i s h. II.2-rasmda  $y = \sin x$  va  $y = x^2 + x + 1$  funksiyalarning grafiklari tasvirlangan.

$x \in [-1; 0]$  bo'lsa,  $\sin x \leq 0$ ,  $x^2 + x + 1 > 0$  bo'lgani uchun tenglamani  $[-1; 0]$  oraliqqa tegishli yechimi mavjud emas.

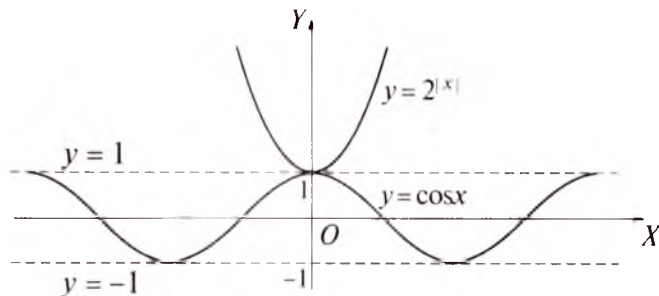

II.1-rasm.

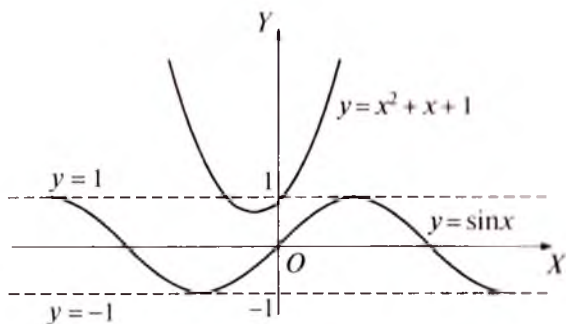

II.2-rasm.

$x \notin [-1; 0]$  lar uchun  $\sin x \leq 1$ ,  $x^2 + x + 1 > 0$  bo'lgani sababli tenglama  $[-1; 0]$  dan tashqarida ham yechimga ega emas. Demak, berilgan tenglama yechimga ega emas.

**Eslatma.** 1-misoldagi tenglamaning (shuningdek, 2-misoldagi tenglamaning ham) yechilishini bayon etishda grafiklarni chizish shart emas edi. Grafiklarni chizish esa tenglamani yechish usulini topish imkonini berdi. Quyida keltiriladigan misollarda u yoki bu funksiyaning grafigini chizish katta qiyinchiliklar tug'diradi. Shu sababli, bu misollarning yechilishini grafik chizish bilan bog'lash maqsadga muvofiq emas.

3 - misol.  $2 \cos \frac{x}{3} = 3^x + 3^{-x}$  tenglamani yechamiz.

**Yechish.** Barcha  $x \in \mathbb{R}$  lar uchun

$$2 \cos \frac{x}{3} \leq 2, \quad 3^x + 3^{-x} \geq 2$$

tengsizliklarga egamiz. Shu sababli, berilgan tenglama  $\begin{cases} 2 \cos \frac{x}{3} = 2, \\ 3^x + 3^{-x} = 2 \end{cases}$

tenglamalar sistemasiga teng kuchlidir. Bu sistemaning ikkinchi tenglamasi  $x = 0$  dan iborat yagona yechimga ega.  $x = 0$  son sistemaning birinchi tenglamasini ham qanoatlantiradi. Shuning uchun,  $x = 0$  sistemaning va berilgan tenglamaning ham yagona yechimi bo'ladi.

4 - misol.  $2\sqrt{2}(\sin x + \cos x) \cos y = 3 + \cos 2y$  tenglamani yechamiz.

Yechish.  $\sin x + \cos x = \sqrt{2} \sin\left(\frac{\pi}{4} + x\right)$  bo'lgani uchun berilgan tenglamani  $2 \sin\left(\frac{\pi}{4} + x\right) \cos y = 1 + \cos^2 y$  ko'rinishda yozib olish mumkin. Oxirgi tenglama  $\left(\cos y - \sin\left(\frac{\pi}{4} + x\right)\right)^2 + \left(1 - \sin^2\left(\frac{\pi}{4} + x\right)\right) = 0$  yoki  $\left(\cos y - \sin\left(\frac{\pi}{4} + x\right)\right)^2 + \cos^2\left(\frac{\pi}{4} + x\right) = 0$  tenglamaga teng kuchlidir. Hosil qilingan tenglama  $\cos y = \sin\left(\frac{\pi}{4} + x\right)$ ,  $\cos\left(\frac{\pi}{4} + x\right) = 0$  tengliklar o'rinli bo'lgandagina to'g'ri tenglikka aylanadi, boshqacha qilib aytganda, u

$$\begin{cases} \cos y = \sin\left(\frac{\pi}{4} + x\right), \\ \cos\left(\frac{\pi}{4} + x\right) = 0 \end{cases}$$

tenglamalar sistemasiga teng kuchlidir.

Sistemaning ikkinchi tenglamasi  $x_1 = \frac{\pi}{4} + 2m\pi$  va  $x_2 = \frac{5\pi}{4} + 2n\pi$  ( $m, n \in \mathbb{Z}$ ) yechimlarga ega. Birinchi tenglamadan  $y_1 = 2k\pi$ ,  $y_2 = (2p+1)\pi$  larni topamiz (bu yerda  $k, p \in \mathbb{Z}$ ).

Shunday qilib, berilgan tenglama  $x_1 = \frac{\pi}{4} + 2m\pi, y_1 = 2k\pi$ , ( $m, k \in \mathbb{Z}$ ) va  $x_2 = \frac{5\pi}{4} + 2n\pi, y_2 = (2p+1)\pi$ , ( $n, p \in \mathbb{Z}$ ) yechimlarga ega.

5 - misol.  $\sin 7x + \cos 2x = -2$  tenglamani yechamiz.

Yechish. Barcha  $x \in \mathbb{R}$  lar uchun  $\sin 7x \geq -1$ ,  $\cos 2x \geq -1$  bo'lgani sababli berilgan tenglama  $\begin{cases} \sin 7x = -1, \\ \cos 2x = -1 \end{cases}$  sistemaga teng

kuchlidir. Birinchi tenglama  $x = -\frac{\pi}{14} + \frac{2\pi k}{7}$ ,  $k \in \mathbb{Z}$  yechimlar guruhiga, ikkinchi tenglama esa  $x = \frac{\pi}{2} + \pi n$ ,  $n \in \mathbb{Z}$  yechimlar guruhiga ega. Har ikki guruhga tegishli  $x$  largina sistemaning yechimi bo'la oladi. Ularni aniqlaymiz:

$$-\frac{\pi}{14} + \frac{2\pi k}{7} = \frac{\pi}{2} + \pi n \quad (k, n \in \mathbb{Z}).$$

Bundan,  $k = 2 + 3,5n$  ekanligini topib,  $k \in \mathbb{Z}$  ekanini e'tiborga olsak,  $n = 2p$  ( $p \in \mathbb{Z}$ ) bo'lishi kelib chiqadi.

Demak,  $x = \frac{\pi}{2} + 2\pi p$  ( $p \in \mathbb{Z}$ ) sonlarga sistemaning, binobarin, berilgan tenglamaning ham yechimlari bo'ladi.

**6 - misol.**  $\log_2^2 x + (x-1)\log_2 x - 6 + 2x = 0$  tenglamani yechamiz.

**Yechish.** Tenglamaning chap tomonini  $t = \log_2 x$  ga nisbatan kvadrat uchhad sifatida qarab, odatdagi standart usulda ko'paytuvchilarga ajratamiz:

$$(\log_2 x + 2)(\log_2 x + x - 3) = 0.$$

Bu tenglama  $\log_2 x = -2$  va  $\log_2 x = 3 - x$  tenglamalarga ajraladi. Ularning birinchisi  $x = \frac{1}{4}$  dan iborat yagona yechimga ega.  $\log_2 x = 3 - x$  tenglama esa  $x = 2$  dan iborat yagona yechimga ega.

Haqiqatan ham,  $x > 2$  bo'lganda  $\log_2 x > \log_2 2 = 1 > 3 - x$  tengsizlikka,  $0 < x < 2$  bo'lganda esa  $\log_2 x < \log_2 2 = 1 < 3 - x$  tengsizlikka egamiz.  $x \leq 0$  da esa tenglama ma'noga ega emas.

Demak, berilgan tenglama  $x = \frac{1}{4}$  va  $x = 2$  yechimlarga ega.



## Mashqlar

Tenglamani yeching.

**2.1.**  $2^{|x|} = \sin x.$

**2.2.**  $2 \cdot 3^{|x|} = 2 \cos \frac{x}{4}.$

**2.3.**  $2 \sin x = 5x^2 + 2x + 3.$

**2.4.**  $4 \cdot 2^{|x|-1} = \sin(\pi\sqrt{x}) + 4.$

**2.5.**  $\cos x + \cos y - \cos(x+y) = 1,5.$

**2.6.**  $\left( \sin^2 x + \frac{1}{\sin^2 x} \right)^2 + \left( \cos^2 x + \frac{1}{\cos^2 x} \right)^2 = 12 + \frac{1}{2} \sin y.$

**2.7.**  $\operatorname{tg}^4 x + \operatorname{tg}^4 y + 2 \operatorname{ctg}^2 x \cdot \operatorname{ctg}^2 y = 3 + \sin^2(x+y).$

**2.8.**  $8 - x \cdot 2^x + 2^{3-x} - x = 0.$

**2.9.**  $x \cdot 2^x = x(3-x) + 2(2^x - 1).$

$$2.10. \log_2 \left( \cos^2 xy + \frac{1}{\cos^2 xy} \right) = \frac{1}{y^2 - 2y + 2}.$$

$$2.11. \sqrt{\frac{x^2 - x - 2}{\sin x}} + \sqrt{\frac{\sin x}{x^2 - x - 2}} = 1,5.$$

$$2.12. \sin^4 x + \cos^{15} x = 1.$$

$$2.13. \sqrt{\sin^3 x} + \sqrt{\cos^3 x} = \sqrt{2}.$$

$$2.14. \sqrt{2 + \cos^2 2x} = \sin 3x - \cos 3x.$$

$$2.15. \sqrt{5 + \sin^2 3x} = \sin x + 2 \cos x.$$

## 2-§. Nostandart tengsizliklar

Oldingi bandda nostandart tenglamalar qaraldi. Nostandart tenglamada tenglik belgisi tengsizlik belgisi bilan almashtirilsa, nostandart tengsizlik deb ataluvchi tengsizlik hosil bo'ladi.

Nostandart tenglamalarni yechishning umumiy usuli mavjud bo'lmagani kabi, nostandart tengsizliklarni yechishning ham umumiy usuli mavjud emas. Shu sababli, nostandart tengsizliklarni yechishda ham shu tengsizlikka xos bo'lgan chuqur mantiqiy fikr yuritishga to'g'ri keladi.

Nostandart tengsizliklarni yechishga doir ayrim misollar bilan tanishaylik.

1 - misol.  $\cos x \geq y^2 + \sqrt{y - x^2} - 1$  tengsizlikni yechamiz.

Yechish.  $x = u$ ,  $y = v$  sonlaridan tuzilgan  $(u; v)$  juftlik berilgan tengsizlikning yechimi bo'lsin. U holda quyidagi to'g'ri sonli tengsizlikka ega bo'lamiz:

$$\cos u \geq v^2 + \sqrt{v - u^2} - 1 \quad (1)$$

(1) tengsizlikda ildiz ostidagi ifoda nomanfiy sondir, ya'ni  $v - u^2 - 1 \geq 0$  dir. Shu sababli,

$$v \geq u^2 + 1, \quad (2)$$

$$v \geq 1, \quad (3)$$

tengsizliklar to'g'ridir.

$\sqrt{v-u^2-1} \geq 0$  ekanligini e'tiborga olib, (1) va (3) tengsizliklardan

$$\cos u \geq v^2 + \sqrt{v-u^2-1} \geq v^2 \geq 1$$

tengsizlikni hosil qilamiz. Biroq  $\cos u \leq 1$ . Shu sababli quyidagi munosabatlar o'rinlidir:

$$1 \geq \cos u \geq v^2 + \sqrt{v-u^2-1} \geq v^2 \geq 1. \quad (4)$$

Bu esa  $1 = \cos u = v^2 + \sqrt{v-u^2-1} = v^2 = 1$  ekanligini ko'rsatadi.

Oxirgi tenglikdan, (3) tengsizlikni e'tiborga olsak,  $v = 1$ ,  $u = 0$  ekanligi kelib chiqadi.

Yuqoridagi mulohazalar, (0; 1) juftlikdan boshqa juftliklar berilgan tengsizlikning yechimi bo'la olmasligini va (0; 1) juftligina berilgan *tengsizlikning yechimi bo'lishi mumkinligini* ko'rsatadi.

(0; 1) juftlik, haqiqatan ham, berilgan tengsizlikning yechimi bo'lishligini ko'rish qiyin emas. Demak, berilgan tengsizlik yagona yechimga ega:  $x = 0$ ,  $y = 1$ .

2 - misol.  $\sin \frac{x}{2\pi} < 2^{|\sin x|}$  tengsizlikni yechamiz.

**Yechish.** Tengsizlikning aniqlanish sohasi  $R$  dan iborat va har qanday  $x \in R$  son uchun quyidagi tengsizliklar o'rinlidir:

$$\sin \frac{x}{2\pi} \leq 1, \quad (5)$$

$$2^{|\sin x|} \geq 1. \quad (6)$$

Bu tengsizliklardan, barcha  $x \in R$  uchun  $\sin \frac{x}{2\pi} \leq 2^{|\sin x|}$  tengsizlik bajarilishi kelib chiqadi. Oxirgi tengsizlikning barcha yechimlari

to'plami  $R$  dan  $\sin \frac{x}{2\pi} = 2^{|\sin x|}$  tenglamaning barcha yechimlari chiqarib tashlansa, berilgan tengsizlikning yechimlari to'plami hosil bo'ladi.

(5) va (6) munosabatlardan ko'rinadiki,  $\sin \frac{x}{2\pi} = 2^{|\sin x|}$  tenglama quyidagi sistemaga teng kuchli:



$$\begin{cases} \sin 2^{\frac{x}{2}} = 1, \\ 2^{|\sin x|} = 1. \end{cases} \quad (7)$$

(7) sistemaning birinchi tenglamasi  $x = \pi \log_2 \left( \frac{\pi}{2} + 2\pi k \right)$ ,  $k = 0, 1, 2, \dots$  yechimlarga, ikkinchi tenglamasi esa  $x = \pi n$ ,  $n = 0, \pm 1, \pm 2, \dots$  yechimlarga ega. (7) sistemaning yechimlarini topish uchun

$$\pi \log_2 \left( \frac{\pi}{2} + 2\pi k \right) = \pi n, \quad (k = 0, 1, 2, \dots; n = 0; \pm 1; \pm 2; \dots)$$

yoki

$$\frac{\pi}{2} + 2\pi k = 2^n, \quad (k = 0, 1, 2, \dots; n = 0; \pm 1; \pm 2; \dots)$$

tenglamani qaraymiz. Oxirgi tenglikning chap tomoni irratsional son, o'ng tomoni esa ratsional son. Shuning uchun bu tenglama va (7) sistema yechimga ega emas. Demak,  $\sin 2^{\frac{x}{2}} = 2^{|\sin x|}$  tenglama yechimga ega emas. Bu yerdan, berilgan tengsizlik barcha  $x \in \mathbb{R}$  sonlarida bajarilishi kelib chiqadi.

3 - misol.  $\arcsin \frac{2}{x} + \sqrt{x-1} > 1$  tengsizlikni yechamiz.

Yechish.  $\begin{cases} \left| \frac{2}{x} \right| \leq 1, \\ x-1 \geq 0 \end{cases}$  sistemani yechib, tengsizlikning aniqlanish sohasi  $[2; +\infty)$  dan iborat ekanligini ko'ramiz.

Barcha  $x \geq 2$  larda  $\sqrt{x-1} \geq 1$  va  $\arcsin \frac{2}{x} > 0$  tengsizliklar to'g'ri bo'lishini ko'rish qiyin emas. Bu tengsizliklardan ko'rinadiki, berilgan tengsizlik o'zining aniqlanish sohasidagi barcha  $x$  lar uchun, ya'ni barcha  $x \in [2; +\infty)$  lar uchun o'rinli bo'ladi.

4 - misol.  $\min\{2x - x^2, x - 1\} > -\frac{1}{2}$  tengsizlikni yechamiz.

Yechish.  $\min\{2x - x^2, x - 1\}$  ni topib olamiz. Buning uchun,  $2x - x^2 \geq x - 1$  tengsizlikning yechimlari to'plami  $\left[ \frac{1-\sqrt{5}}{2}; \frac{1+\sqrt{5}}{2} \right]$  oraliqdan iborat ekanligidan foydalanamiz.

$x \in \left[ \frac{1-\sqrt{5}}{2}; \frac{1+\sqrt{5}}{2} \right]$  larda  $2x - x^2 \geq x - 1$  bo'lgani uchun

$$\min_{x \in \left[ \frac{1-\sqrt{5}}{2}; \frac{1+\sqrt{5}}{2} \right]} \{2x - x^2, x - 1\} = x - 1,$$

$$\min_{x \in \left( -\infty; \frac{1+\sqrt{5}}{2} \right)} \{2x - x^2, x - 1\} = 2x - x^2 \text{ va}$$

$$\min_{x \in \left[ \frac{1+\sqrt{5}}{2}; +\infty \right)} \{2x - x^2, x - 1\} = 2x - x^2$$

munosabatlar o'rinlidir (II. 3-rasmga qarang).

$$\min_{x \in R} \{2x - x^2, x - 1\} = \begin{cases} 2x - x^2, & x \leq \frac{1-\sqrt{5}}{2} \text{ da,} \\ x - 1, & \frac{1-\sqrt{5}}{2} \leq x \leq \frac{1+\sqrt{5}}{2} \text{ da,} \\ 2x - x^2, & x \geq \frac{1+\sqrt{5}}{2} \text{ da} \end{cases}$$

munosabatdan foydalansak, berilgan tengsizlik quyidagi majmua-ga teng kuchli ekanligini ko'ramiz:

$$\begin{cases} 2x - x^2 > -\frac{1}{2}, \\ x \leq \frac{1-\sqrt{5}}{2}; \\ x - 1 > -\frac{1}{2}, \\ \frac{1-\sqrt{5}}{2} \leq x \leq \frac{1+\sqrt{5}}{2}; \\ 2x - x^2 > -\frac{1}{2}, \\ x \geq \frac{1+\sqrt{5}}{2}. \end{cases}$$

Bu majmuani yechib, berilgan tengsizlikning barcha yechimlarini topamiz:

$$\frac{1}{2} < x < 1 + \sqrt{\frac{3}{2}}.$$

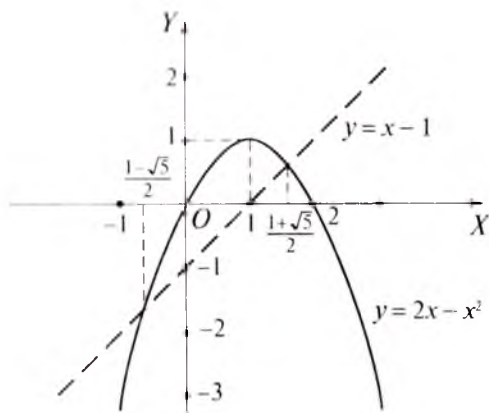

II.3-rasm.



## Mashqlar

Tengsizlikni yeching:

2.16.  $-(y + x \geq \sqrt{x^2 + y^2} - 1 + 1.$

2.17.  $-x - y^2 - \sqrt{x - y^2} - 1 \geq -1.$

2.18.  $\sqrt{\sin x} + \sqrt{\cos x} > 1.$

2.19.  $|x| + \sqrt{x^2 - 1} \geq 1.$

2.20.  $\lg x + \sqrt{x^2 - 1} \geq 0.$

2.21.  $\log_2(x^2 + 3) + \sqrt{x^2 - 1} \geq 2.$

2.22.  $x + 2^x \leq \sqrt{1 - x} + 3.$

2.23.  $x + 2^x + \sqrt{x - 1} \geq 2 + \sqrt{x}.$

2.24.  $2^{\sqrt{1-x}} \geq x.$

2.25.  $2^{\sqrt{1-x}} - x \lg x > 0.$

2.26.  $\sqrt{x-1} + \sqrt{4-x^2} + \operatorname{tg} \frac{\pi x}{4} > 1.$

2.27.  $\sqrt{\lg \sin x} < x - 13\pi.$

2.28.  $\frac{\lg(|x|+1)}{\lg(|x|-1)} + \sqrt{x^2 - 4} > 1.$

2.29.  $\cos^2(x+1) \cdot \lg(9 - 2x - x^2) \geq 1\sqrt{2}.$

2.30.  $(4x - x^2 - 3) \log_2(\cos^2 \pi x + 1) \geq 1.$

2.31.  $\cos(x + 3\operatorname{tg} x) + (\operatorname{tg} x - \operatorname{tg}^2 x)^2 \leq -1.$

2.32.  $\sin(\sin x) \leq \frac{\sqrt{3}}{2}.$

2.33.  $|\sin x + \cos x| \leq 2^{|\cos x|}.$

2.34.  $\frac{4}{3} \sin^2 \{5x\} \leq 2^{1-|\sin x|}.$

2.35.  $\sin\{x\} < \sin(\{x\} + 1).$

2.36.  $\sqrt{x-1} + 2^x + \log_2 x \geq 2.$

2.37.  $\sqrt{x-1} + 2^x + \log_2 x < 6.$

2.38.  $\sqrt{1-x} + 3 \geq x + 2^x.$

2.39.  $\{x\} > \{2x\}.$

2.40.  $\max\left\{x^2 - 2x, \frac{x}{2} - 1\right\} < -\frac{1}{2}.$

### 3-§. Nostandart sistemalar

Nostandart sistema deyilganda qanday sistemalar nazarda tutilishi quyidagi misollardan oydinlashadi.

$$1 - \text{misol. } \begin{cases} 2^{x+1} = 4y^2 + 1, \\ 2^x \leq 2y \end{cases} \text{ sistemani yechamiz.}$$

Yechish. Sistemadagi tenglamadan  $2^x = 2y^2 + \frac{1}{2}$  tenglamani hosil qilib, sistemadagi tengsizlikda  $2^x$  ni  $2y^2 + \frac{1}{2}$  bilan almashtiramiz:

$$\begin{cases} 2^x = 2y^2 + \frac{1}{2}, \\ 2y^2 + \frac{1}{2} \leq 2y. \end{cases}$$

Bu sistemadagi tengsizlik  $(y - \frac{1}{2})^2 \leq 0$  tengsizlikka teng kuchli bo'lgani uchun  $y = \frac{1}{2}$  dan iborat yagona yechimga egadir.  $y = \frac{1}{2}$  qiymatni sistemadagi tenglamaga qo'yib,  $x = 0$  ni topamiz. Demak, berilgan sistema  $(0; \frac{1}{2})$  dan iborat yagona yechimga ega.

$$2 - \text{misol. } \begin{cases} x^2 - 2xy + 12 = 0, \\ x^2 + 4y^2 \leq 60, \\ x \in Z \end{cases} \text{ sistemani yechamiz.}$$

Yechish. Agar  $(x; y)$  juftlik sistemaning yechimi bo'lsa, u holda  $(-x; -y)$  juftlik ham sistemaning yechimi bo'lishligini ko'rish qiyin emas. Shu sababli,  $x \geq 0$  holni qarash yetarli.

Agar  $x = 0$  bo'lsa, sistemadagi tenglama noto'g'ri tenglikka aylanadi. Demak,  $x > 0$  bo'lishi zarur ( $x \geq 0$  bo'lgan hol qaralmoqda!).

Sistemadagi tenglamadan  $y$  ni topaylik:  $y = \frac{x^2+12}{2x} = \frac{x}{2} + \frac{6}{x}$ . O'rta arifmetik va o'rta geometrik miqdorlar orasidagi munosabatni

ifodalovchi  $a + b \geq 2\sqrt{ab}$  ( $a \geq 0$ ,  $b \geq 0$ ) tengsizlikdan foydalanib,  $y \geq 2\sqrt{\frac{x}{2} \cdot \frac{6}{x}} = 2\sqrt{3}$  yoki  $y^2 \geq 12$  ekanligini ko'ramiz. Bunga ko'ra, sistemadagi tengsizlikdan,  $x^2 \leq 60 - 4y^2 \leq 60 - 4 \cdot 12 = 12$  ni, ya'ni  $x^2 \leq 12$  ni olamiz.  $x > 0$ ,  $x \in Z$  ekanligini e'tiborga olsak,  $x = 1$ ,  $x = 2$ ,  $x = 3$  bo'lishi zarurligini ko'ramiz.

$x = 1$  bo'lsin. U holda, tenglamadan  $y = 12$  ekanligini topamiz. Lekin (1; 12) juftlik uchun  $x^2 + 4y^2 \leq 60$  shart bajarilmaydi. Demak,  $x = 1$  soni sistemaning yechimini aniqlamaydi.

$x = 2$  soni sistemaning yechimini aniqlamasligi shunga o'xshash ko'rsatiladi.

$x = 3$  bo'lgan holni qaraymiz. Tenglamadan  $y = 9$  ekanligi topiladi. (3; 9) juftlik sistemadagi qolgan shartlarni ham qanoatlantiradi. Demak, (3; 9) — yechim.

Yuqoridagi eslatilganiga asosan, (-2; -9) juftlik ham sistemaning yechimi bo'ladi.

Shunday qilib, sistema (2; 9) va (-2; -9) dan iborat ikkita yechimga ega.

3 - misol. 
$$\begin{cases} \operatorname{tg}^2 x + \operatorname{ctg}^2 x = 2 \sin^2 y, \\ \sin^2 y + \cos^2 z = 1 \end{cases} \text{ sistemani yechamiz.}$$

Yechish.  $\operatorname{tg}^2 x + \operatorname{ctg}^2 x \geq 2$ ,  $2 \sin^2 y \leq 2$  bo'lgani uchun sistemadagi birinchi tenglama 
$$\begin{cases} \operatorname{tg}^2 x + \operatorname{ctg}^2 x = 2, \\ \sin^2 y = 1 \end{cases} \text{ sistemaga teng}$$

kuchlidir. Shu sababli, berilgan sistema quyidagi sistemaga teng kuchli bo'ladi:

$$\begin{cases} \operatorname{tg}^2 x + \operatorname{ctg}^2 x = 2, \\ \sin^2 y = 1, \\ \sin^2 y + \cos^2 z = 1. \end{cases}$$

Bu sistemani quyidagicha yozib olish mumkin:

$$\begin{cases} \operatorname{tg}^2 x = 1, \\ \sin^2 y = 1, \\ \cos^2 z = 0. \end{cases}$$

Oxirgi sistemadan  $x = \frac{\pi}{4} + \frac{\pi}{2}k$ ,  $y = \frac{\pi}{2} + \pi l$ ,  $z = \frac{\pi}{2} + \pi m$  bo'lishligini topamiz (bu yerda  $k \in \mathbb{Z}$ ,  $l \in \mathbb{Z}$ ,  $m \in \mathbb{Z}$ ).

$$4\text{-misol.} \begin{cases} y^6 + y^3 + 2x^2 = \sqrt{xy - x^2 y^2}, \\ 4xy^3 + y^3 + \frac{1}{2} \geq 2x^2 + \sqrt{1 + (2x - y)^2} \end{cases} \quad (*)$$

sistemani yechamiz.

**Yechish.**  $f(z) = \sqrt{z - z^2}$  funksiyani qaraymiz. Bu funksiya  $\frac{1}{2}$  ga teng eng katta qiymatga ega, ya'ni ixtiyoriy  $z$  haqiqiy son uchun  $f(z) = \sqrt{z - z^2} \leq \frac{1}{2}$  munosabat o'rinalidir.

$(x^*; y^*)$  juftlik berilgan sistemaning yechimi bo'lsin. U holda  $(y^*)^6 + (y^*)^3 + 2(x^*)^2 = \sqrt{x^* y^* - (x^*)^2 (y^*)^2} \leq \frac{1}{2}$  ga ega bo'lamiz.

Demak, berilgan sistemaning har qanday  $(x^*; y^*)$  yechimi quyidagi sistemaning ham yechimi bo'ladi:

$$\begin{cases} (y^*)^6 + (y^*)^3 + 2(x^*)^2 \leq \frac{1}{2}, \\ 4x^* y^* + (y^*)^3 + \frac{1}{2} \geq 2(x^*)^2 + \sqrt{1 + (2x^* - y^*)^2}. \end{cases}$$

Bu sistemaning birinchi tengsizligidan ikkinchi tengsizligini ayirsak,

$(y^*)^6 + 2(x^*)^2 - 4x^* (y^*)^3 - \frac{1}{2} \leq \frac{1}{2} - 2(x^*)^2 - \sqrt{1 + (2x^* - y^*)^2}$  tengsizlik va shakl almashtirishlardan so'ng

$$((y^*)^3 - 2x^*)^2 \leq 1 - \sqrt{1 + (2x^* - y^*)^2}$$

tengsizlikni hosil qilamiz. Bu tengsizlikning chap tomoni  $\geq 0$ , o'ng tomoni esa  $\leq 0$  ekanini ko'rish qiyin emas. Demak, bu tengsizlik

$$\begin{cases} (y^*)^3 - 2x^* = 0, \\ \sqrt{1 + (2x^* - y^*)^2} = 1 \end{cases}$$

sistemaga teng kuchlidir. Oxirgi sistema quyidagi yechimlarga ega:

$$x_1^* = 0, y_1^* = 0; x_2^* = -\frac{1}{2}, y_2^* = -1; x_3^* = \frac{1}{2}, y_3^* = 1.$$

Demak,  $(0; 0)$ ,  $(-\frac{1}{2}; -1)$ ,  $(\frac{1}{2}; 1)$  juftliklarga (\*) sistemaning yechimi bo'lishi mumkin. Bu juftliklarni (\*) sistemaga qo'yib ko'rish bilan,  $(-\frac{1}{2}; -1)$  juftligina (\*) sistemaning yechimi bo'lishiga ishonch hosil qilamiz.



## Mashqlar

Sistemani yeching:

$$2.41. \begin{cases} 3^{x+4} = y^2 + 1, \\ 3^x \leq \frac{2y}{81}. \end{cases}$$

$$2.42. \begin{cases} x + y + z = 2, \\ 2xy - z^2 = 4. \end{cases}$$

$$2.43. \begin{cases} x + y + z = 4, \\ 2xy - z^2 = 16. \end{cases}$$

$$2.44. \begin{cases} y^2 + xy - z^2 = 4, \\ x + 5y = 8. \end{cases}$$

$$2.45. \begin{cases} x^2 - 2yz = -1, \\ y + z - x = 1. \end{cases}$$

$$2.46. \begin{cases} \log_2(u+v) - \log_3(u-v) = 1, \\ u^2 - v^2 = 2. \end{cases}$$

$$2.47. \begin{cases} 3^{\lg x} = 4^{\lg y}, \\ (4x)^{\lg 4} = (3y)^{\lg 3}. \end{cases}$$

$$2.48. \begin{cases} \cos x - \cos y = \sin(x+y), \\ |x| + |y| = \frac{\pi}{4}. \end{cases}$$

$$2.49. \begin{cases} 2x^2 - xy + 10 = 0, \\ x^2 + y^2 \leq 90, \\ x \in Z. \end{cases}$$

$$2.50. \begin{cases} 2x^2 - xy + 9 = 0, \\ 2x^2 + y^2 \leq 81, \\ x \in Z. \end{cases}$$

### III B O B

## SONLI KETMA-KETLIKLAR VA ULARNING LIMITI



### 1-§. Cheksiz sonli ketma-ketliklar

**1. Ketma-ketlik tushunchasi.** Har bir natural son  $n$  ( $n \in N$ ) ga biror qoida bo'yicha  $x_n$  haqiqiy son mos qo'yilgan bo'lsin. U holda

$$x_1; x_2; x_3; \dots; x_n; \dots \quad (1)$$

sonli ketma-ketlik berilgan deyiladi va bu ketma-ketlik  $\{x_n\}$  ko'rinishda belgilanadi.

$x_1, x_2, x_n$  sonlar, mos ravishda, (1) ketma-ketlikning birinchi hadi, ikkinchi hadi va  $n$ - hadi deyiladi.

$x_n$  ketma-ketlikning *umumiy hadi* deb ataladi.

Ketma-ketlikning aniqlanishidan ko'rinadiki, ketma-ketlik natural sonlar to'plamida berilgan  $y=f(n)$  funksiyadir. Shuning uchun ketma-ketlik *natural argumentli funksiya* deb ham yuritiladi.

**1 - m i s o l.** Umumiy hadi  $x_n = \frac{1}{n^2}$  bo'yicha sonli ketma-ketlik tuzish uchun unga tartib bilan  $n = 1; 2; 3; \dots$  qo'yamiz. Natijada quyidagi ketma-ketlik hosil bo'ladi:

$$1; \frac{1}{4}; \frac{1}{9}; \frac{1}{16}; \dots; \frac{1}{n^2}; \frac{1}{(n+1)^2}; \dots$$

**2 - m i s o l.** Har bir toq natural songa 3 ni, har bir juft natural songa esa 5 ni mos keltiramiz:

$n$	1	2	3	4	5	6	7	8	...
$x_n$	3	5	3	5	3	5	3	5	...

Natijada 3; 5; 3; 5; 3; 5; 3; 5; ... cheksiz sonli ketma-ketlikka ega bo'lamiz. Uning umumiy hadini bir necha formula bilan, masalan,  $a_n = 4 + (-1)^n$  yoki  $a_n = 4 + (-1)^n + \sin\pi n$  formula bilan berish mumkin.

Cheksiz sonli ketma-ketliklar turli xil usullarda berilishi mumkin. Shu usullardan ayrimlarini keltiramiz.



1. Ketma-ketlikning *umumiy had formulasi* bilan berilishi. Bu usulda  $n$ -hadning qiymatini shu hadning tartib nomeri bilan bog'lovchi formula beriladi (1-misol). Umumiy had formulas yordamida ketma-ketlikning istalgan hadini topish mumkin, ya'ni bu formula ketma-ketlikni to'la aniqlaydi.

2. Ketma-ketlik *o'z hadining tartib nomeri* bilan shu hadning qiymati orasidagi moslikni so'zlar orqali ifodalash yordamida berilishi mumkin (2-misol).

3. Ketma-ketlikning *rekurrent* usulda berilishi. Agar ketma-ketlikning dastlabki bitta yoki bir nechta hadlari berilgan bo'lib keyingi hadlarni shu berilgan hadlar yordamida topish imkonin beruvchi formula (rekurrent formula) ko'rsatilgan bo'lsa, ketma-ketlik rekurrent usulda berilgan deyiladi. (Rekurrent so'zi lotin tilida qaytish degan ma'noni beradi.)

3 - m i s o l .  $a_1 = 3$ ,  $a_n = 2^n \cdot a_{n-1} - 4$  ( $n \geq 2$ ) bo'lsa,  $\{a_n\}$  ketma-ketlikning  $a_2$ ,  $a_3$ ,  $a_4$  hadlarini topamiz.

Y e c h i s h . Bu yerda  $\{a_n\}$  ketma - ketlik rekurrent usulda berilgan.  $a_1 = 3$  bo'lgani uchun rekurrent formula  $a_n = 2^n \cdot a_{n-1} - 4$  ga asosan

$$a_2 = 2^2 \cdot a_1 - 4 = 4 \cdot 3 - 4 = 8,$$

$$a_3 = 2^3 \cdot a_2 - 4 = 8 \cdot 8 - 4 = 60,$$

$$a_4 = 2^4 \cdot a_3 - 4 = 8 \cdot 60 - 4 = 476$$

ekanligini topamiz.

Ketma-ketlik jadval yoki grafik ko'rinishida berilishi ham mumkin. Ketma-ketlikning grafigi diskret nuqtalar to'planidan iborat bo'ladi (lotincha — *discretus* — uzlukli, alohida qismlardan iborat).

Agar ketma-ketlikning dastlabki bir nechta hadlari berilgan bo'lib, keyingi hadlarni berilgan hadlar orqali ifodalash usul aytilmagan bo'lsa, bu hadlarning berilishi ketma-ketlikning to'liq aniqlanishi uchun yetarli bo'lmaydi. Masalan, 3; 5; 7; . . . ketma-ketlikni 2 dan katta toq sonlar yoki 2 dan katta tub sonlar ketma-ketligi sifatida, shuningdek,  $x_n = 2n + 1 + \sin \pi n$  formula bilan berilgan ketma-ketlik sifatida ham qarash mumkindir.

Dastlabki hadlariga ko'ra ketma-ketlik uchun biror umumiy had tanlash usullaridan birini keltiramiz.

4 - m i s o l . Ushbu jadval bilan berilgan sonli ketma-ketlikning umumiy hadini topamiz:

$n$	2	4	6	8
$a_n$	-6	6	26	54

Jadvalda ketma-ketlikning 2, 4, 6, 8- hadlari berilgan.

**Yechish.** Bu holda jadvalni oddiy kuzatishning o'zi yetarli emas.

Shuning uchun chekli ayirmalar usuli, ya'ni  $\Delta a_n = a_{n+1} - a_n$  dan foydalanamiz:

$n$	2	4	6	8
$a_n$	-6	6	26	54
$\Delta a_n$	12	20	28	
$\Delta^2 a_n$	8	8		

Birinchi  $\Delta a_n$  chekli ayirmalar  $a_n$  ning ketma-ket joylashgan qiymatlari ayirmasidan iborat:  $6 - (-6) = 12$ ,  $26 - 6 = 20$ ,  $54 - 26 = 28$ .

Shu kabi,  $\Delta^2 a_n$  ikkinchi ayirmalar  $\Delta a_n$  ning ketma-ket joylashgan qiymatlaridan iborat:  $20 - 12 = 8$ ,  $28 - 20 = 8$ .

$\Delta^2 a_n$  ayirmalar bir xil. Demak,  $(a_n)$  ketma-ketlik  $y = ax^2 + bx + c$  kvadrat funksiya qiymatlaridan iborat. Formulada  $a$ ,  $b$ ,  $c$  - noma'lum. Ularni topish uchun jadvaldan ixtiyoriy  $(n, a_n)$  juftlik bo'yicha tenglamalar sistemasini tuzamiz. Masalan,  $(2; -6)$ ,  $(4; 6)$ ,  $(6; 26)$  juftliklar bo'yicha:

$$\begin{cases} -6 = a \cdot 2^2 + b \cdot 2 + c, \\ 6 = a \cdot 4^2 + b \cdot 4 + c, \\ 26 = a \cdot 6^2 + b \cdot 6 + c, \end{cases}$$

bundan  $a = 1$ ,  $b = 0$ ,  $c = -10$ .

Demak, izlanayotgan umumiy had formulasi  $a_n = n^2 - 10$  dan iborat bo'ladi.



## Mashqlar

**3.1.** Umumiy hadi formulasi bilan berilgan ketma-ketlikning dastlabki bir nechta hadlarini toping:

1)  $x_n = 2n^3 + 1$ ;

2)  $x_n = 2^n + 3$ ;

- 3)  $x_n = \sqrt{n^2 + 1}$ ;                      4)  $x_n = \sin \frac{\pi n}{2}$ ;  
 5)  $x_n = \ln n + \sin\left(\pi n + \frac{\pi}{2}\right)$ ;                      6)  $x_n = \cos n^2$ ;  
 7)  $x_n = \operatorname{tgn} n + \sin(\pi n)$ ;                      8)  $x_n = 1 - \sin^2 \pi n - \cos^2 \pi n$ .

**3.2.** Rekurrent formula bilan berilgan ketma-ketlikning dastlabki 5 ta hadini toping.

- 1)  $a_1 = 1, a_{m+1} = 3a_m - 1, (m \geq 1)$ ;  
 2)  $a_1 = 2, a_{n+1} = a_n + n, (n \geq 1)$ ;  
 3)  $a_1 = -1, a_n = 3^{a_{n-1}}, (n \geq 2)$ ;  
 4)  $a_1 = 2, a_2 = 3, a_{n+1} = a_n - a_{n-1} + a_n a_{n-1}, (n \geq 2)$ .

**3.3.** Ketma-ketlikning berilgan dastlabki hadlariga ko'ra, uning  $n$ -hadi uchun mumkin bo'lgan biror formula tanlang:

- 1)  $\frac{1}{2}; \frac{2}{2^2}; \frac{3}{2^3}; \frac{4}{2^4}; \dots$ ;                      5)  $\frac{1}{3}; \frac{4}{9}; \frac{9}{27}; \frac{16}{81}; \dots$ ;  
 2)  $\left(\frac{1}{3}\right)^2; \left(\frac{2}{5}\right)^2; \left(\frac{3}{7}\right)^2; \left(\frac{4}{9}\right)^2; \dots$ ;                      6)  $1; \frac{5}{6}; \frac{5}{6}; \frac{17}{20}; \frac{13}{15}; \dots$ ;  
 3)  $1; \frac{2}{101}; \frac{4}{201}; \frac{8}{301}; \dots$ ;                      7)  $\frac{1}{2}; \frac{2}{5}; \frac{3}{10}; \frac{4}{17}; \dots$ ;  
 4)  $1; \frac{1}{2\sqrt{2}}; \frac{1}{3\sqrt{3}}; \frac{1}{4\sqrt{4}}; \dots$ ;                      8)  $0; \frac{1}{2}; \frac{8}{3}; \frac{15}{4}; \frac{24}{5}; \dots$

**3.4.**  $a_n = 3^n + 5 \cdot 2^n$  ketma-ketlik quyidagi rekurrent formula yordamida berilishi mumkinligini isbotlang:

$$a_1 = 13; a_2 = 29; a_{n+2} = 5a_{n+1} - 6a_n \quad (n \geq 1).$$

**3.5.**  $a_1 = 0, a_2 = 1, a_n = a_{n-2} + a_{n-1} (n \geq 3)$  rekurrent formula bilan berilgan ketma-ketlik *Fibonachchi ketma-ketligi*, uning hadlari esa *Fibonachchi sonlari* deyiladi. Fibonachchi ketma-ketligining dastlabki bir nechta hadlarini toping. Fibonachchi ketma-ketligining  $n$ -hadi uchun formula toping.

**2. Chegaralangan ketma-ketliklar.**  $\{x_n\}$  cheksiz ketma-ketlik berilgan bo'lsin.

Agar  $\{x_n\}$  ketma-ketlik uchun shunday bir  $a$  haqiqiy son topilib, barcha  $n$  natural sonlar uchun  $x_n \geq a$ , ( $x_n \leq a$ ) tengsizlik bajarilsa,  $\{x_n\}$  ketma-ketlik *quyidan (yuqoridan) chegaralangan* deyiladi.

Agar  $\{x_n\}$  ketma-ketlik uchun ikkita  $a$  va  $b$  haqiqiy sonlar topilib, barcha  $n$  natural sonlar uchun  $a \leq x_n \leq b$  tengsizlik bajarilsa,  $\{x_n\}$  ketma-ketlik *chegaralangan* ketma-ketlik deyiladi.

Bunda  $a$  son  $\{x_n\}$  ketma-ketlikning *quyi chegarasi*,  $b$  son esa *yuqori chegarasi* deyiladi.

1 - misol.  $x_n = \frac{n-1}{n+1}$  ketma-ketlik chegaralangan ketma-ketlik ekanligini isbot qilamiz.

Isbot. Barcha  $n$  natural sonlar uchun quyidagi tengsizliklar to'g'ridir:

$$x_n = \frac{n-1}{n+1} \geq \frac{n-n}{n+1} = 0;$$

$$x_n = \frac{n-1}{n+1} \leq \frac{n+1}{n+1} = 1.$$

Demak,  $0 \leq x_n \leq 1$  tengsizlik barcha  $n$  natural sonlarda o'rinli. Bu esa  $\{x_n\}$  ketma-ketlikning chegaralanganligini ko'rsatadi.

**Teorema.** Agar  $\{x_n\}$  ketma-ketlik chegaralangan bo'lsa, u holda shunday  $M \geq 0$  son topiladiki, barcha  $n$  natural sonlar uchun  $|x_n| \leq M$  tengsizlik bajariladi va aksincha,  $\{x_n\}$  ketma-ketlik uchun shunday bir  $M \geq 0$  son topilib, barcha  $n$  natural sonlarda  $|x_n| \leq M$  tengsizlik bajarilsa,  $\{x_n\}$  ketma-ketlik chegaralangan bo'ladi.

Isbot.  $\{x_n\}$  ketma-ketlik chegaralangan bo'lsin. U holda shunday  $a$  va  $b$  haqiqiy sonlar topiladiki, barcha  $n$  natural sonlarda  $a \leq x_n \leq b$  tengsizlik bajariladi.  $|a|$  va  $|b|$  sonlarning eng kattasini  $M$  bilan belgilaymiz:  $M = \max(|a|; |b|)$ .

U holda  $a \geq -|a| \geq -M$ ,  $b \leq |b| \leq M$  bo'lgani uchun barcha  $n$  natural sonlarda  $-M \leq x_n \leq M$  yoki  $|x_n| \leq M$  bo'ladi.

Endi  $\{x_n\}$  ketma-ketlik uchun shunday bir  $M \geq 0$  son topilib, barcha  $n$  natural sonlarda  $|x_n| \leq M$  tengsizlik o'rinli bo'lsin. U holda,  $-M \leq x_n \leq M$  tengsizlikka ega bo'lamiz.  $a = -M$ ,  $b = M$  deb olsak,  $\{x_n\}$  ketma-ketlikning chegaralangan bo'lishligini ko'ramiz.

2 - misol.  $x_n = (-1)^n + \frac{n^2}{n^2+1}$  ketma-ketlikning chegaralangan ketma-ketlik ekanligini isbotlang.

Isbot.

$$|x_n| = \left| (-1)^n + \frac{n^2}{n^2+1} \right| \leq \left| (-1)^n \right| + \left| \frac{n^2}{n^2+1} \right| = 1 + \frac{n^2}{n^2+1} \leq 1 + \frac{n^2}{n^2} = 1 + 1 = 2$$

munosabatlardan ko'rinadiki, barcha  $n$  natural sonlarda  $|x_n| \leq 2$  tengsizlik o'rinli. Demak, isbotlangan teorema ko'ra  $\{x_n\}$  chegaralangan ketma-ketlikdir.

Ketma-ketliklar orasida chegaralanganlik sharti bajarilmaydigan ketma-ketliklar ham mavjuddir. Ular *chegaralanmagan* ketma-ketliklar deyiladi. Quyida biz chegaralanmagan ketma-ketlikning qat'iy matematik ta'rifini beramiz.

**Ta'rif.** Agar ixtiyoriy  $M > 0$  son uchun, shunday bir  $N$  natural son topilib,  $|x_n| > M$  tengsizlik bajarilsa,  $\{x_n\}$  ketma-ketlik chegaralanmagan ketma-ketlik deyiladi.

3 - m i s o l.  $x_n = n^2$  ketma-ketlik chegaralanmagan ketma-ketlik ekanligini isbotlaymiz.

**Isbot.**  $M$  ixtiyoriy musbat son bo'lsin.  $|x_n| > M$  tengsizlikni natural son  $n$  ga nisbatan yechamiz:

$$|n^2| > M \Leftrightarrow n^2 > M \Leftrightarrow n > \sqrt{M}, \quad (n - \text{natural son}).$$

Oxirgi tengsizlikdan ko'rinadiki, ta'rifda so'z borgan  $N$  natural son sifatida  $\sqrt{M}$  dan katta bo'lgan har qanday natural sonni olish mumkin. Biz  $N = [\sqrt{M}] + 1$  natural sonni olamiz. Bu son

uchun  $|x_N| = N^2 = ([\sqrt{M}] + 1)^2 > ([\sqrt{M}] + \{\sqrt{M}\})^2 = (\sqrt{M})^2 = M$ , ya'ni  $|x_N| > M$  bo'ladi.

Demak,  $\{x_n\}$  ketma-ketlik chegaralanmagan ketma-ketlikdir.

Agar ketma-ketlikning hadlarini to'g'ri chiziqdagi nuqtalar bilan tasvirlasak, chegaralangan ketma-ketlikning hamma hadlari biror oraliqda yotishini ko'ramiz. Masalan,  $x_n = \frac{1}{n}$  ketma-ketlik chegaralangan va uning hamma hadlari  $[0; 1]$  oraliqda yotadi.

Chegaralanmagan ketma-ketliklar uchun esa buning aksidir ya'ni, har qanday oraliqni olmaylik, chegaralanmagan ketma-ketlikning bu oraliqda yotmaydigan hadlari albatta mavjud bo'ladi.



## Mashqlar

**3.6.** Ketma-ketlikning chegaralanganligini isbotlang:

$$1) x_n = \frac{2n^2 - 1}{2 + n^2}; \quad 3) x_n = \frac{1 - n}{\sqrt{n^2 + 1}};$$

$$2) x_n = \frac{n + (-1)^n}{3n - 1}; \quad 4) x_n = \frac{(-1)^n}{n^2 + 1}.$$

**3.7.** Ketma-ketlikning chegaralanmaganligini isbotlang.

$$1) a_n = (-1)^n \cdot n; \quad 2) a_n = n^2 - n; \quad 3) a_n = \frac{1 - n}{\sqrt{n}};$$

$$4) a_n = n + (-1)^n \cdot n; \quad 5) a_n = n \cdot \sin \frac{\pi n}{2}; \quad 6) a_n = n^2 \cos \frac{\pi n}{2}.$$

**3.8.**  $\{x_n\}$  va  $\{y_n\}$  ketma-ketliklar chegaralangan ketma-ketliklar bo'lsa, quyidagi ketma-ketlikni chegaralangan yoki chegaralanmaganligi haqida nima deyish mumkin:

$$1) x_n y_n; \quad 2) \frac{x_n}{y_n}; \quad 3) x_n + y_n; \quad 4) x_n - y_n?$$

**3.9.** 1) Agar  $x_n \leq y_n$  ( $n = 1, 2, 3, \dots$ ) bo'lib,  $\{y_n\}$  chegaralangan ketma-ketlik bo'lsa,  $\{x_n\}$  ketma-ketlik chegaralangan bo'lishi shartmi?

$$2) |x_n| \leq |y_n| \text{ bo'lsa-chi?}$$

**3.10.** 1)  $a_1 = 1$ ,  $a_2 = 2$ ,  $a_{n+2} = \frac{a_{n+1}}{a_n}$ , ( $n \geq 1$ ) rekurrent formulalar bilan berilgan ketma-ketliklarning chegaralanganligini isbotlang;

2) a) yuqoridan chegaralangan, lekin quyidan chegaralanmagan;

b) quyidan chegaralangan, lekin yuqoridan chegaralanmagan;

d) quyidan ham, yuqoridan ham chegaralanmagan ketma-ketlik tuzing.

3)  $a_n = 1 + \frac{1}{2} + \frac{1}{3} + \dots + \frac{1}{n}$  ketma-ketlikning chegaralanmaganligini isbotlang.

**3. Monoton ketma-ketliklar.**  $\{x_n\}$  ketma-ketlik berilgan bo'lsin. Agar ketma-ketlikning ikkinchi hadidan boshlab, har bir hadi o'zidan oldingi haddan katta (kichik) bo'lsa, ya'ni  $x_{n+1} > x_n$

$(x_{n+1} < x_n)$  shart barcha natural  $n$  sonlar uchun bajarilsa,  $\{x_n\}$  ketma-ketlik o'suvchi (kamayuvchi) ketma-ketlik deyiladi.

1 - misol.  $x_n = 3n^3$  ketma-ketlik o'suvchi ekanini isbotlang.

Isbot.  $x_{n+1} - x_n$  ayirmani qaraymiz:

$$x_{n+1} - x_n = 3(n+1)^3 - 3n^3 = 3(n^3 + 3n^2 + 3n + 1) - 3n^3 = 3(3n^2 + 3n + 1).$$

Bu ayirma  $n$  ning istalgan natural qiymatida musbatdir. Shu sababli, barcha  $n$  natural sonlarda  $x_{n+1} > x_n$ , ya'ni  $\{x_n\}$  ketma-ketlik o'suvchidir.

2 - misol.  $x_n = \frac{1}{n^2}$  ketma-ketlikning kamayuvchi ekanligini isbotlang.

Isbot. Bu ketma-ketlikning hamma hadlari bir xil ishorali bo'lgani uchun  $\frac{x_{n+1}}{x_n}$  nisbatni baholaymiz:

$$\frac{x_{n+1}}{x_n} = \frac{\frac{1}{(n+1)^2}}{\frac{1}{n^2}} = \frac{n^2}{(n+1)^2} < 1,$$

$x_n > 0$  bo'lgani uchun, barcha natural  $n$  larda  $x_{n+1} < x_n$  tengsizlikka egamiz. Demak,  $\{x_n\}$  kamayuvchi ketma-ketlikdir.

Agar  $\{x_n\}$  ketma-ketlikning ikkinchi hadidan boshlab, har bir hadi o'zidan oldingi haddan kichik (katta) bo'lmasa, ya'ni  $x_{n+1} \geq x_n$  ( $x_{n+1} \leq x_n$ ) tengsizlik barcha  $n$  natural sonlarda bajarilsa,  $\{x_n\}$  ketma-ketlik kamaymaydigan (o'smaydigan) ketma-ketlik deyiladi.

Masalan, 1; 2; 2; 2; 3; 3; 3; 3; 4; 4; 4; ... ketma-ketlik kamaymaydigan, 1;  $\frac{1}{2}$ ;  $\frac{1}{2}$ ;  $\frac{1}{2}$ ;  $\frac{1}{3}$ ;  $\frac{1}{3}$ ;  $\frac{1}{3}$ ;  $\frac{1}{4}$ ;  $\frac{1}{4}$ ;  $\frac{1}{4}$ ; ... ketma-ketlik esa o'smaydigan ketma-ketlikdir.

Har qanday o'suvchi ketma-ketlik kamaymaydigan ketma-ketlik bo'lishini, har qanday kamayuvchi ketma-ketlik esa o'smaydigan ketma-ketlik bo'lishini eslatib o'tamiz.

O'smaydigan ketma-ketliklar va kamaymaydigan ketma-ketliklar (umumiy nom bilan) *monoton* ketma-ketliklar deb ataladi.

3 - misol.  $x_n = \frac{n+1}{2n-1}$  ketma-ketlikni monotonlikka tekshiramiz.

Yechish.  $x_{n+1} - x_n = \frac{n+2}{2n+1} - \frac{n+1}{2n-1} = -\frac{3}{4n^2-1} < 0$  tengsizlik  $n$  ning barcha natural qiymatlarida o'rinli. Demak, ixtiyoriy  $n$  natural son uchun  $x_{n+1} < x_n$  tengsizlik to'g'ridir. Bu yerdan,  $\{x_n\}$  ketma-ketlikning monotonligi kelib chiqadi.

4 - misol.  $n \geq 2$  bo'lsa,  $x_n = \left(1 + \frac{1}{n}\right)^{n+1}$  ketma-ketlikni monotonlikka tekshiramiz.

Yechish.

$$\frac{x_n}{x_{n-1}} = \left(\frac{1+\frac{1}{n}}{1+\frac{1}{n-1}}\right)^n \cdot \left(1+\frac{1}{n}\right) =$$

$$= \left(1 - \frac{1}{n^2}\right)^n \cdot \left(1+\frac{1}{n}\right) < \left(1 - \frac{1}{n^2}\right)^n \cdot \left(1+\frac{1}{n^2}\right)^n = \left(1 - \frac{1}{n^4}\right)^n < 1$$

tengsizlikdan,  $\{x_n\}$  ketma-ketlikning kamayuvchi ekanligi kelib

chiqadi (Eslatma:  $1 + \frac{1}{n} < 1 + n \cdot \frac{1}{n^2} + \dots = \left(1 + \frac{1}{n^2}\right)^n$ ).

Demak,  $\{x_n\}$  ketma-ketlik monoton ketma-ketlikdir.

5 - misol.  $x_n = \begin{cases} -(2k-1), & \text{agar } n = 2k-1, k = 1, 2, 3, \dots; \\ 2, & \text{agar } n = 2k, k = 1, 2, 3, \dots \end{cases}$

ketma-ketlikni monotonlikka tekshiring.

Yechish. Ketma-ketlikni, uning hadlarini ko'rsatish orqali beraylik:

$$-1; 2; -3; 2; -4; 2; \dots$$

Bu ketma-ketlik monoton ketma-ketlik emas, chunki juft nomerli har qanday hadi o'zidan oldingi haddan ham, shuningdek o'zidan keyingi haddan ham katta.



## Mashqlar

**3.11.**  $a_n = \sqrt{n+1} - \sqrt{n}$  ketma-ketlik kamayuvchi ekanligini isbotlang.

**3.12.** Ketma-ketlik monoton ekanligini isbotlang:

1)  $a_n = \frac{1-n}{\sqrt{n}}$ ;      2)  $a_n = 2^n - 1$ .



**3.13.**  $a$ ,  $b$ ,  $c$  va  $d$  sonlar orasida qanday munosabat bajarilsa,  $a_n = \frac{an+b}{cn+d}$  ketma-ketlik: 1) o'suvchi; 2) kamayuvchi bo'ladi?

**4. Progressiyalar.** Ketma-ketliklarning muhim xususiy holi bo'lgan progressiyalarni qaraymiz.  $\{x_n\}$  cheksiz sonli ketma-ketlik berilgan bo'lsin.

Agar  $\{x_n\}$  ketma-ketlik uchun shunday o'zgarmas  $d$  son topilib, barcha  $n$  natural sonlar uchun  $x_{n+1} = x_n + d$  tenglik o'rinli bo'lsa,  $\{x_n\}$  ketma-ketlik *arifmetik progressiya* deyiladi.

Agar  $\{x_n\}$  ketma-ketlik uchun shunday  $q \neq 0$  o'zgarmas son topilib, barcha  $n$  natural sonlarda  $x_{n+1} = x_n \cdot q$  tenglik bajarilsa va  $x_1 \neq 0$  bo'lsa,  $\{x_n\}$  ketma-ketlik *geometrik progressiya* deyiladi.

$d$  son arifmetik progressiyaning *ayirmasi*,  $q$  son esa geometrik progressiyaning *maxraji* deyiladi.

1 - misol.  $a_n = kn + m$  (bu yerda  $k$ ,  $m$  — o'zgarmas haqiqiy sonlar) ketma-ketlikning arifmetik progressiya,  $b_n = ca^{kn+m}$  (bu yerda  $c \neq 0$ ,  $a > 0$ ,  $k \geq 0$ ,  $m \geq 0$ ) ketma-ketlikning esa geometrik progressiya bo'lishligini isbotlang.

**I s b o t .**  $n$  ning istalgan natural qiymatida

$$a_{n+1} - a_n = (k(n+1) + m) - (kn + m) = k \text{ va } \frac{b_{n+1}}{b_n} = \frac{c \cdot a^{k(n+1)+m}}{c \cdot a^{kn+m}} = a^k,$$

ya'ni  $a_{n+1} = a_n + k$ ,  $b_{n+1} = b_n a^k$  tengliklar o'rinli. Demak,  $\{a_n\}$  ketma-ketlik ayirmasi  $d = k$  bo'lgan arifmetik progressiya,  $\{b_n\}$  ketma-ketlik esa maxraji  $q = a^k$  bo'lgan geometrik progressiyadir.

**1 - t e o r e m a .** *Ayirmasi  $d$  ga teng bo'lgan  $\{a_n\}$  arifmetik progressiyaning umumiy hadi uchun*

$$a_n = a_1 + (n-1)d, \quad (1)$$

*maxraji  $q$  ga teng bo'lgan  $\{b_n\}$  geometrik progressiyaning umumiy hadi uchun esa*

$$b_n = b_1 q^{n-1} \quad (2)$$

*tenglik o'rinlidir.*

Isbot. Arifmetik va geometrik progressiyalarning ta'rifidan quyidagilarga ega bo'lamiz:

$$(n-1) \text{ ta } \begin{cases} a_2 = a_1 + d, \\ a_3 = a_2 + d, \\ a_4 = a_3 + d, \\ a_5 = a_4 + d, \\ \dots, \\ a_{n-1} = a_{n-2} + d, \\ a_n = a_{n-1} + d, \end{cases} \quad (3) \quad (n-1) \text{ ta } \begin{cases} b_2 = b_1 \cdot q, \\ b_3 = b_2 \cdot q, \\ b_4 = b_3 \cdot q, \\ b_5 = b_4 \cdot q, \\ \dots, \\ b_{n-1} = b_{n-2} \cdot q, \\ b_n = b_{n-1} \cdot q. \end{cases} \quad (4)$$

(3) dagi tengliklarni hadma-had qo'shib, (4) dagi tengliklarni esa hadma-had ko'paytirib,

$$(a_2 + a_3 + a_4 + a_5 + \dots + a_{n-1}) + a_n = a_1 + (a_2 + a_3 + a_4 + \dots + a_{n-2} + a_{n-1}) + (n-1)d$$

va

$$(b_2 \cdot b_3 \cdot \dots \cdot b_{n-1}) \cdot b_n = b_1 \cdot (b_2 \cdot b_3 \cdot \dots \cdot b_{n-1}) \cdot q^{n-1}$$

tengliklarni hosil qilamiz. Bu tengliklardan teoremaning tasdig'i o'rinli ekanligi kelib chiqadi.

2 - misol.  $(a_n)$  ketma-ketlik ayirmasi  $d$  bo'lgan arifmetik progressiya,  $(b_n)$  ketma-ketlik esa maxraji  $q$  bo'lgan geometrik progressiya bo'lsin. U holda ixtiyoriy  $n$  va  $k$  natural sonlar uchun,

$$a_n = a_k + (n-k)d \quad (5)$$

$$b_n = b_k \cdot q^{n-k} \quad (6)$$

tengliklar o'rinli bo'lishini isbotlaymiz.

Isbot. 1-teoremaga ko'ra,  $a_n = a_1 + (n-1)d$  va  $a_k = a_1 + (k-1)d$  tengliklar o'rinli. Bu tengliklarning ikkinchisidan,  $a_1 = a_k - (k-1)d$  ni topib, birinchisiga qo'ysak va ixchamlashni bajarsak, isbotlanishi kerak bo'lgan (5) tenglik hosil bo'ladi.

(6) tenglik ham shu tarzda isbotlanadi.

Natija.  $(a_n)$  arifmetik progressiyaning ayirmasi  $d$  uchun  $d = \frac{a_n - a_k}{n-k}$ ,  $(n \neq k)$  tenglik,  $(b_n)$  geometrik progressiya maxraji  $q$

$$\text{uchun esa } |q| = \begin{cases} \left| \frac{b_n}{b_k} \right|, & \text{agar } n = k + 1, \\ n-k \sqrt{\left| \frac{b_n}{b_k} \right|}, & \text{agar } n - k \geq 2 \end{cases} \quad \text{munosabat o'rinli}$$

(Mustaqil isbotlang).

**2 - teorema.**  $\{a_n\}$  ketma-ketlik ayirmasi  $d$  bo'lgan arifmetik progressiya,  $\{b_n\}$  ketma-ketlik esa maxraji  $q$  bo'lgan geometrik progressiya bo'lsin. Agar  $m, n, p, k$  natural sonlar uchun  $m + n = p + k$  tenglik bajarilsa,

$$a_m + a_n = a_p + a_k, \quad (7)$$

$$b_m \cdot b_n = b_p \cdot b_k \quad (8)$$

tengliklar o'rinli bo'ladi.

**Isbot.**  $m, n, p, k$  natural sonlar uchun  $m + n = p + k$  bo'lsin. U holda, 1-teoremaga ko'ra

$$a_m + a_n = 2a_1 + (m + n - 2)d = 2a_1 + (p + k - 2)d = a_p + a_k$$

va

$$b_m \cdot b_n = b_1^2 \cdot q^{m+n-2} = b_1^2 \cdot q^{p+k-2} = b_p \cdot b_k$$

tengliklarga ega bo'lamiz.

**3 - misol.**  $(a_n)$  arifmetik progressiyada  $a_{17} = 310$ ,  $a_{23} = 418$  bo'lsa:

a) progressiya ayirmasi  $d$  ni; b)  $a_{41}$  ni; d)  $a_9 + a_{31}$  ni; e)  $a_{20}$  ni; f)  $a_5$  ni topamiz.

$$\text{Yechish. a) } d = \frac{a_{23} - a_{17}}{23 - 17} = \frac{418 - 310}{6} = \frac{108}{6} = 18;$$

$$\text{b) } a_{41} = a_{17} + (41 - 17)d = 310 + 24 \cdot 18 = 742;$$

d)  $9 + 31 = 17 + 23$  bo'lgani uchun 2-teoremaga ko'ra

$$a_9 + a_{31} = a_{17} + a_{23} = 728;$$

e)  $20 + 20 = 17 + 23$  bo'lgani uchun  $2a_{20} = a_{17} + a_{23} = 728$ ,  $a_{20} = 364$ .

$$\text{f) } a_5 = a_{17} + (5 - 17)d = 310 - 12 \cdot 18 = 94.$$

4 - misol. Barcha hadlari musbat bo'lgan  $(b_n)$  geometrik progressiyada  $b_6 = 320$ ,  $b_{10} = 5120$  bo'lsa, quyidagilarni topamiz:

a) geometrik progressiya maxraji  $q$  ni; b)  $b_{13}$  ni; d)  $b_4$  ni; e)  $b_7 \cdot b_9$  ni; f)  $b_8$  ni.

$$\text{Yechish: a) } |q| = \sqrt[10-6]{\frac{b_{10}}{b_6}} = \sqrt[4]{\frac{5120}{320}} = \sqrt[4]{16} = 2, \quad b_n > 0$$

( $n = 1, 2, 3, \dots$ ) bo'lgani uchun  $q > 0$  va, demak,  $q = 2$ ;

$$\text{b) } b_{13} = b_6 \cdot q^{13-6} = 320 \cdot 2^7 = 320 \cdot 128 = 40960;$$

$$\text{d) } b_4 = b_6 \cdot b^{4-6} = 320 \cdot 2^{-2} = \frac{320}{4} = 80;$$

$$\text{e) } 7 + 9 = 6 + 10 \quad \text{bo'lgani uchun} \quad b_7 \cdot b_9 = b_6 \cdot b_{10} = \\ = 320 \cdot 5120 = 1638400;$$

f)  $8 + 8 = 6 + 10$  bo'lgani uchun  $b_8^2 = b_8 \cdot b_8 = b_6 \cdot b_{10} = 1638400$ ,  
 $|b_8| = 1280$ .  $b_8 > 0$  bo'lgani uchun  $b_8 = 1280$  ga ega bo'lamiz.

Endi arifmetik progressiya dastlabki  $n$  ta hadlarining yig'indisi  $S_n = a_1 + a_2 + a_3 + \dots + a_{n-2} + a_{n-1} + a_n$  uchun formula hosil qilamiz:

$$2S_n = (a_1 + a_n) + (a_2 + a_{n-1}) + (a_3 + a_{n-2}) + \dots + (a_{n-2} + a_3) + \\ + (a_{n-1} + a_2) + (a_n + a_1).$$

Bu tenglikning o'ng tomonida  $n$  ta qo'shiluvchi mavjud bo'lib,  
 $1 + n = 2 + (n - 1) = 3 + (n - 2) = \dots = (n - 2) + 3 = (n - 1) + 2 = n + 1$   
 tengliklar o'rinli. Shu sababli 2-teoremaga ko'ra qo'shiluvchilarning hammasi  $a_1 + a_n$  ga tengdir.

$2S_n = (a_1 + a_n)n$  tenglikka ega bo'ldik. Bundan,

$$S_n = \frac{a_1 + a_n}{2} \cdot n$$

formula hosil bo'ladi.

5 - misol.  $(a_n)$  arifmetik progressiyada  $a_{20} = 364$  bo'lsa,  $S_{39}$  ni toping.

$$\text{Yechish. } S_{39} = \frac{a_1 + a_{39}}{2} \cdot 39 = \frac{a_{20} + a_{20}}{2} \cdot 39 = 364 \cdot 39 = 14196.$$

Geometrik progressiya dastlabki  $n$  ta hadining yig'indisi uchun formula chiqaramiz.  $(b_n)$  geometrik progressiya,  $q$  esa uning max-

raji bo'lsin.  $(b_n)$  geometrik progressiya dastlabki  $n$  ta hadining yig'indisini  $S_n$  bilan belgilaymiz.

Agar  $q = 1$  bo'lsa,  $S_n = nb_1$  bo'ladi.

$q \neq 1$  holni qaraymiz.

$$\begin{aligned} S_n - S_n q &= (b_1 + b_2 + \dots + b_{n-1} + b_n) - (b_1 + b_2 + \dots + b_{n-1} + b_n)q = \\ &= b_1 - b_n q \end{aligned}$$

tenglikdan  $S_n$  ni topamiz:

$$S_n = \frac{b_1 - b_n q}{1 - q}, \quad (q \neq 1).$$

6 - misol.  $(b_n)$  geometrik progressiyada  $b_1 = 3$ ,  $q = 2$  bo'lsa,  $S_{11}$  ni toping.

Yechish.  $b_{11} = b_1 \cdot q^{11-1} = 3 \cdot 2^{10} = 3 \cdot 1024 = 3072$  bo'lgani uchun

$$S_{11} = \frac{3-3072 \cdot 2}{1-2} = \frac{3-6144}{-1} = 6141.$$



## Mashqlar

**3.14.**  $(a_n)$  arifmetik progressiyaning ayirmasi  $d$  bo'lsin.

- 1) Agar  $d > 0$  bo'lsa,  $(a_n)$  ning o'suvchi;
- 2) agar  $d < 0$  bo'lsa,  $(a_n)$  ning kamayuvchi;
- 3) agar  $d = 0$  bo'lsa,  $(a_n)$  ning o'smaydigan ketma-ketlik bo'lishini isbotlang.

**3.15.** Arifmetik progressiyaning 2- hadidan boshlab, har bir hadi o'zidan oldingi va keyingi hadlarning o'rtasidagi arifmetigi bo'lishini isbotlang.

**3.16.** 1) Ayirmasi noldan farqli bo'lgan arifmetik progressiyaning chegaralanmagan ketma-ketlik ekanligini isbotlang.

2)  $S_n = \frac{2a_1 + (n-1)d}{2} \cdot n$  formulani mustaqil isbotlang.

**3.17.**  $\{b_n\}$  ketma-ketlik maxraji  $q$  bo'lgan geometrik progressiya bo'lsin. Quyidagilarni isbotlang:

- 1)  $q < 0$  bo'lsa,  $\{b_n\}$  ketma-ketlik monoton bo'lmaydi.
- 2)  $b_1 > 0$ ,  $q > 1$  bo'lsa,  $\{b_n\}$  ketma-ketlik o'suvchi bo'ladi.
- 3)  $b_1 > 0$ ,  $0 < q < 1$  bo'lsa,  $\{b_n\}$  ketma-ketlik kamayuvchi bo'ladi.
- 4)  $b_1 < 0$ ,  $q > 1$  bo'lsa,  $\{b_n\}$  ketma-ketlik kamayuvchi bo'ladi.

5)  $b_1 < 0$ ,  $0 < q < 1$  bo'lsa,  $\{b_n\}$  ketma-ketlik o'suvchi bo'ladi.

6)  $S_n = \frac{1-q^n}{1-q} \cdot b_1$ , ( $q \neq 1$ ).

**3.18.** 1)  $(b_n)$  geometrik progressiyaning ikkinchi hadidan boshlab, har bir hadining kvadrati qo'shni hadlar ko'paytmasiga tengligini isbotlang:

$$b_n^2 = b_{n-1} \cdot b_{n+1}, \quad (n \geq 2).$$

2)  $(a_n)$  ketma-ketlik arifmetik progressiya ekanligini bilgan holda har qaysi satrdagi berilgan uchta ma'lumotga ko'ra qolgan noma'lum miqdorlar qiymati topilsin:

$N$	$a_1$	$d$	$n$	$a_n$	$S_n$
1	110	-10	11		
2	4	$-\frac{1}{4}$	13		
3	5		26	105	
4	$\frac{3}{4}$		26	$3\frac{7}{18}$	
5		3	12		210
6		2	15	-10	

$N$	$a_1$	$d$	$n$	$a_n$	$S_n$
7	0	0,5		5	
8	-9	$\frac{1}{2}$			-75
9	-28		9		0
10	0,2			5,2	137,2
11			30	$15\frac{3}{4}$	$146\frac{1}{4}$
12		0,3		50,3	2551,3

3)  $(b_n)$  ketma-ketlik geometrik progressiya bo'lsa, har qaysi satrdagi berilgan uchta ma'lumotga ko'ra qolgan noma'lum miqdorlar qiymati topilsin.

$N$	$b_1$	$q$	$n$	$b_n$	$S_n$
1	1	3	10		
2		$\frac{1}{2}$	8	2	
3	2		7	1458	
4		3		567	847
5	$\frac{1}{2}$			$\frac{1}{128}$	$\frac{127}{128}$
6	$\frac{1}{3}$	$\frac{1}{3}$		$\frac{1}{6561}$	
7		-2	19	262144	
8		-3	4		30

## 2-§. Ketma-ketlikning limiti

Limit tushunchasi matematik analiz fanining muhim tushunchalaridan biridir. Biz dastlab ketma-ketlikning limiti tushunchasi bilan tanishib chiqamiz.

**1. Ketma-ketlikning qirqimi. Cheksiz kichik ketma-ketliklar.**  $\{x_n\}$  cheksiz ketma-ketlik berilgan bo'lsin. Uning dastlabki  $N-1$  ta hadini tashlab yuborishdan hosil bo'ladigan  $x_N, x_{N+1}, x_{N+2}, \dots$  cheksiz sonli ketma-ketlik  $\{x_n\}$  ketma-ketlikning  $N$ - qirqimi deb ataladi va  $\{x_n\}_{n=N}^{\infty}$  ko'rinishda belgilanadi.

$\{x_n\}$  ketma-ketlikning dastlabki bir nechta qirqimlarini keltiraylik:

$$x_1, x_2, x_3, x_4, x_5, \dots \text{ (1-qirqim, } \{x_n\}_{n=1}^{\infty} \text{);}$$

$$x_2, x_3, x_4, x_5, \dots \text{ (2-qirqim, } \{x_n\}_{n=2}^{\infty} \text{);}$$

$$x_3, x_4, x_5, \dots \text{ (3-qirqim, } \{x_n\}_{n=3}^{\infty} \text{).}$$

*Agar barcha  $n \geq N$  natural sonlar uchun  $|x_n| < \varepsilon$  tengsizlik bajarilsa,  $\{x_n\}_{n=N}^{\infty}$  qirqim 0 ning  $\varepsilon$  - atrofida yotadi deyiladi.*

1 - misol.  $x_n = \frac{1}{n}$  ketma-ketlik berilgan.  $a = 0$  sonning  $\varepsilon = 0,01$  - atrofi uchun  $\{x_n\}$  ketma-ketlikning shu atrofda yotadigan biror qirqimi mavjud yoki mavjud emasligini aniqlaymiz.

**Yechish.** Bunday qirqimning mavjud yoki mavjud emasligi  $|x_n| < 0,01$  tengsizlikning biror  $N$  natural sondan boshlab, barcha natural sonlar uchun bajarilishi yoki bajarilmasligiga bog'liqdir. Shu sababli,  $|x_n| < 0,01$  tengsizlikni  $n$  natural songa nisbatan yechib olishimiz tabiiydir:

$$|x_n| < 0,01, \quad \left| \frac{1}{n} \right| < 0,01 \Leftrightarrow \frac{1}{n} < 0,01 \Leftrightarrow n > 100.$$

$N = 101$  sonini olamiz. U holda barcha  $n \geq 101$  natural sonlari uchun,  $|x_n| = \frac{1}{n} \leq \frac{1}{101} < 0,01$  bo'ladi.

Demak,  $a = 0$  sonning  $\varepsilon = 0,01$  - atrofi uchun  $x_n = \frac{1}{n}$  ketma-ketlikning shu atrofda yotadigan qirqimi mavjud. Bunday qirqim sifatida, masalan,  $\{x_n\}_{n=101}^{\infty}$  qirqimni olish mumkin. Bu qirqimdan keyingi qirqimlar ham shu atrofda yotishini eslatib o'tamiz.

Ma'lum bo'lishicha,  $a = 0$  sonning ixtiyoriy  $\varepsilon$  - atrofini olmaylik,  $x_n = \frac{1}{n}$  ketma-ketlikning shu atrofga tegishli bo'ladigan biror qirqimi mavjud bo'ladi, ya'ni ixtiyoriy  $\varepsilon > 0$  son uchun shunday  $N$  natural son mavjudki, barcha  $n \geq N$  natural sonlar uchun  $|x_n| < \varepsilon$  tengsizlik bajariladi.

2 - misol.  $a = 0$  sonning ixtiyoriy  $\varepsilon$ -atrofi uchun  $x_n = \frac{1}{n}$  ketma-ketlikning shu atrofga tegishli bo'ladigan biror qirqimi mavjudligini isbotlang.

Isbot.  $\varepsilon$  - ixtiyoriy musbat son bo'lsin.  $|x_n| < \varepsilon$  tengsizlikni  $n$  natural songa nisbatan yechib olaylik:

$$\left| \frac{1}{n} \right| < \varepsilon \Leftrightarrow \frac{1}{n} < \varepsilon \Leftrightarrow n > \frac{1}{\varepsilon}.$$

$\frac{1}{\varepsilon}$  dan katta biror natural son  $N$  ni, masalan,  $N = \left[ \frac{1}{\varepsilon} \right] + 1$  natural sonni olamiz. U holda barcha  $n \geq N$  natural sonlar uchun

$$|x_n| = \frac{1}{n} \leq \frac{1}{N} = \frac{1}{\left[ \frac{1}{\varepsilon} \right] + 1} < \frac{1}{\left[ \frac{1}{\varepsilon} \right] + \left( \frac{1}{\varepsilon} \right)} = \frac{1}{\frac{1}{\varepsilon}} = \varepsilon$$

bo'ladi, ya'ni  $\{x_n\}$  ketma-ketlikning  $\{x_n\}_{n=N}^{\infty}$  qirqimi 0 sonining  $\varepsilon$  - atrofida yotadi.

$\{x_n\}$  ketma-ketlik berilgan bo'lsin. Agar  $a = 0$  nuqtaning ixtiyoriy  $\varepsilon$  - atrofi uchun,  $\{x_n\}$  ketma-ketlikning shu atrofda yotuvchi biror  $\{x_n\}_{n=N}^{\infty}$  qirqimi mavjud bo'lsa,  $\{x_n\}$  ketma-ketlik cheksiz kichik ketma-ketlik deyiladi.

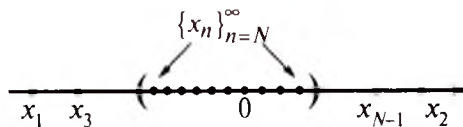

III.1-rasm.



2-misoldan,  $x_n = \frac{1}{n}$  ketma-ketlikning cheksiz kichik ketma-ketlik ekanligi kelib chiqadi.

Cheksiz kichik ketma-ketlikning aniqlanishidan ko'rinadiki, agar  $\{x_n\}$  ketma-ketlik cheksiz kichik ketma-ketlik bo'lsa, u holda 0 ning har qanday atrofini olmaylik, bu atrofda ketma-ketlikning biror hadidan boshlab barcha hadlari yotadi (III.1-rasm). Atrofdan tashqarida esa ko'pi bilan chekli sondagi hadlar qolishi mumkin.

Agar 0 nuqta atrofining radiusini kattalashtirib boraversak, cheksiz kichik ketma-ketlikning hamma hadlari nolning biror atrofiga tushib qoladi. Bundan, cheksiz kichik ketma-ketlik chegaralangan ketma-ketlikdir, degan xulosa kelib chiqadi.



## Mashqlar

**3.19.** Ketma-ketlikning cheksiz kichik ketma-ketlik ekanligini isbotlang:

$$1) x_n = \frac{(-1)^n}{n}; \quad 2) x_n = 0; \quad 3) x_n = \frac{3n+1}{n^2-4};$$

$$4) x_n = \sqrt{\frac{1}{n}}; \quad 5) x_n = \frac{(-1)^n}{\sqrt{n^3}}; \quad 6) x_n = \frac{n^3}{n^4+1}.$$

**3.20.** Ketma-ketlikning cheksiz kichik ketma-ketlik emasligini isbotlang.

$$1) 1; 2; \frac{1}{2}; 2; \frac{1}{3}; 2; \frac{1}{4}; 2; \frac{1}{5}; \dots; \quad 2) \left\{ \frac{n^2+1}{2n} \right\};$$

$$3) x_n = n+1; \quad 4) x_n = 1-n; \quad 5) x_n = n^2-1.$$

**3.21.** Ketma-ketlik cheksiz kichik ketma-ketlik bo'ladimi:

$$1) x_n = 1 - \frac{1}{n}; \quad 2) x_n = 1 + (-1)^n; \quad 3) x_n = \frac{n}{n^2-3};$$

$$4) x_n = \frac{13}{13n-17}; \quad 5) x_n = \frac{n}{(-1)^n n^2+1} ?$$

**2. Cheksiz kichik ketma-ketliklar haqidagi asosiy teoremlar.**  
Cheksiz kichik ketma-ketliklarni grek alifbosi harflaridan foydalanib,

$\alpha_n, \beta_n, \gamma_n, \dots$  kabi belgilash qulaydir. Cheksiz kichik ketma-ketliklar haqidagi teoremlarni shu belgilashlarda bayon etamiz.

**1 - t e o r e m a .**  $\alpha_n, \beta_n$  ketma-ketliklar cheksiz kichik ketma-ketliklar bo'lsa,  $\gamma_n = \alpha_n + \beta_n$  ketma-ketlik ham cheksiz kichik ketma-ketlik bo'ladi.

**I s b o t .**  $\varepsilon$  ixtiyoriy musbat son bo'lsin. 0 ning  $\frac{\varepsilon}{2}$ -atrofida qaraymiz.  $\alpha_n$  cheksiz kichik ketma-ketlik bo'lgani uchun shunday  $N_1$  natural son topiladiki, uning  $\alpha_{N_1}$  hadidan boshlab barcha hadlari qaralayotgan atrofda yotadi, ya'ni barcha  $n \geq N_1$  lar uchun  $|\alpha_n| < \frac{\varepsilon}{2}$  tengsizlik bajariladi. Xuddi shu kabi  $\beta_n$  cheksiz kichik ketma-ketlik bo'lgani uchun shunday  $N_2$  natural son topiladiki, uning  $\beta_{N_2}$  hadidan boshlab barcha hadlari qaralayotgan atrofda yotadi, ya'ni barcha  $n \geq N_2$  natural sonlar uchun  $|\beta_n| < \frac{\varepsilon}{2}$  bo'ladi.

$N_1$  va  $N_2$  sonlaridan katta bo'lgan ixtiyoriy  $N$  natural sonni olib,  $\{\alpha_n\}_{n=N}^{\infty}$  va  $\{\beta_n\}_{n=N}^{\infty}$  qirqimlarni qaraylik. Ularning har biri 0 sonining qaralayotgan  $\frac{\varepsilon}{2}$  - atrofida yotadi:

$$|\alpha_n| < \frac{\varepsilon}{2}, \quad (n \geq N); \quad |\beta_n| < \frac{\varepsilon}{2}, \quad (n \geq N).$$

Shu sababli  $\gamma_n$  ketma-ketlikning  $\{\gamma_n\}_{n=N}^{\infty}$  qirqimi 0 sonining  $\varepsilon$  - atrofida yotadi:

$$|\gamma_n| = |\alpha_n + \beta_n| \leq |\alpha_n| + |\beta_n| < \frac{\varepsilon}{2} + \frac{\varepsilon}{2} = \varepsilon, \quad (\text{bu yerda } n \geq N).$$

Demak, ixtiyoriy  $\varepsilon > 0$  son uchun shunday  $N$  natural son mavjudki, barcha  $n \geq N$  natural sonlarda  $\gamma_n < \varepsilon$  tengsizlik o'rinli, ya'ni  $\gamma_n$  cheksiz kichik ketma-ketlik.

**2 - t e o r e m a .**  $\{x_n\}$  chegaralangan ketma-ketlik,  $\alpha_n$  esa cheksiz kichik ketma-ketlik bo'lsa,  $\gamma_n = x_n \cdot \alpha_n$  ketma-ketlik cheksiz kichik ketma-ketlik bo'ladi.

**I s b o t .**  $\{x_n\}$  ketma-ketlik chegaralangan ketma-ketlik bo'lgani uchun, shunday  $M > 0$  son mavjudki, barcha  $n$  natural sonlar uchun

$$|x_n| \leq M$$

tengsizlik bajariladi.

$\varepsilon$  ixtiyoriy musbat son bo'lsin. 0 sonining  $\frac{\varepsilon}{M}$  - atrofini olamiz.

$\alpha_n$  cheksiz kichik bo'lgani uchun, shunday  $N$  natural son mavjudki, uning  $\alpha_N$  hadidan boshlab barcha hadlari olingan atrofda yotadi, ya'ni barcha  $n \geq N$  da  $|\alpha_n| < \frac{\varepsilon}{M}$  bo'ladi.

$\{\gamma_n\}_{n=N}^{\infty}$  qirqimni qaraymiz.  $n \geq N$  larda

$$|\gamma_n| = |x_n \cdot \alpha_n| = |x_n| \cdot |\alpha_n| < M \cdot \frac{\varepsilon}{M} = \varepsilon$$

bo'lgani uchun, bu qirqim 0 sonining  $\varepsilon$  - atrofida yotadi. Demak,  $\gamma_n$  cheksiz kichik ketma-ketlik.

**3 - teorema.** Agar  $\alpha_n, \beta_n$  ketma-ketliklar cheksiz kichik ketma-ketliklar bo'lsa,  $\alpha_n - \beta_n$  ketma-ketlik ham cheksiz kichik ketma-ketlik bo'ladi.

**Isbot.**  $x_n = -1$  chegaralangan ketma-ketlik,  $\beta_n$  esa cheksiz kichik ketma-ketlik bo'lgani uchun  $\{x_n \cdot \beta_n\}$  ketma-ketlik cheksiz kichik ketma-ketlikdir (2-teorema). Shu sababli,

$$\gamma_n = \alpha_n - \beta_n = \alpha_n + (-1) \cdot \beta_n = \alpha_n + x_n \cdot \beta_n$$

ketma-ketlik cheksiz kichikdir (1-teorema).

Isbotlangan teoremlardan quyidagi natijalar kelib chiqadi.

**1 - natija.** Chekli sondagi cheksiz kichik ketma-ketliklarning algebraik yig'indisi ham cheksiz kichik ketma-ketlik bo'ladi (Isbotlang).

**2 - natija.** Cheksiz kichik ketma-ketliklarning ko'paytmasi ham cheksiz kichik ketma-ketlikdir.

**3 - natija.**  $\alpha_n$  cheksiz kichik ketma-ketlik bo'lsa,  $c \cdot \alpha_n$  ( $c = \text{const}$ ) va  $\alpha_n^k$  ( $k$  - natural son) ketma-ketliklar ham cheksiz kichik ketma-ketlik bo'ladi.



## Mashqlar

**3.22.** Cheksiz kichik ketma-ketlik bo'ladigan bir nechta ketma-ketlik tuzing.

**3.23.** Ketma-ketlikning cheksiz kichik ketma-ketlik ekanligini isbotlang:

$$1) x_n = \frac{\frac{3}{n} - \frac{2}{n^2}}{18 + \frac{15}{n} + \frac{6}{n^2}};$$

$$2) x_n = \frac{n}{3n+1} - \frac{2n^2-1}{6n^2+1};$$

$$3) x_n = 1 - \frac{3}{3n+5};$$

$$4) x_n = \frac{(-1)^n \sin\left(\frac{\pi n}{2}\right)}{n^3}.$$

**3.24.**  $x_n = \frac{2n+1}{4n-3}$  ketma-ketlikni o'zgarmas son bilan cheksiz kichik ketma-ketlikning yig'indisi ko'rinishida tasvirlang.

**3. Cheksiz katta ketma-ketliklar.**  $\{x_n\}$  ketma-ketlik berilgan bo'lsin. Agar ixtiyoriy  $E > 0$  son uchun, unga bog'liq bo'lgan shunday bir  $N = N(E)$  natural son topilib, barcha  $n \geq N$  natural sonlarda  $|x_n| \geq E$  tengsizlik bajarilsa,  $\{x_n\}$  ketma-ketlik *cheksiz katta ketma-ketlik* deyiladi.

**1-misol.**  $x_n = n^2$  ketma-ketlik cheksiz katta ketma-ketlik bo'lishligini isbotlaymiz.

**Isbot.**  $E$  ixtiyoriy musbat son bo'lsin.  $|x_n| = |n^2| = n^2 \geq E$  tengsizlikni natural son  $n$  ga nisbatan yechib,  $n \geq \sqrt{E}$  ni olamiz.  $N = [\sqrt{E}] + 1$  sonni qaraylik. U holda barcha  $n \geq N$  natural sonlar uchun

$$|x_n| = n^2 \geq N^2 = ([\sqrt{E}] + 1)^2 > ([\sqrt{E}] + \{\sqrt{E}\})^2 = (\sqrt{E})^2 = E,$$

ya'ni  $|x_n| > E$  tengsizlik bajariladi. Demak,  $x_n = n^2$  ketma-ketlik cheksiz katta ketma-ketlik.

Cheksiz katta ketma-ketlikning aniqlanishidan ko'rinadiki, agar  $\{x_n\}$  cheksiz katta ketma-ketlik bo'lsa, u holda nolning har qanday atrofini olmaylik,  $\{x_n\}$  ketma-ketlikning biror  $x_N$  hadidan boshlab barcha hadlari shu atrofdan tashqarida yotadi.

Cheksiz katta ketma-ketlik bilan cheksiz kichik ketma-ketlik orasidagi munosabatni ifodalovchi teoremani isbotlaymiz.

**Teorema.** a) Agar  $\{x_n\}$  ketma-ketlik cheksiz katta ketma-ketlik bo'lib,  $x_n \neq 0$  ( $n = 1, 2, 3, \dots$ ) bo'lsa,  $y_n = \frac{1}{x_n}$  ketma-ketlik cheksiz kichik ketma-ketlik bo'ladi.

b)  $\{y_n\}$  ketma-ketlik cheksiz kichik ketma-ketlik bo'lib,  $y_n \neq 0$  ( $n = 1, 2, 3, \dots$ ) bo'lsa,  $x_n = \frac{1}{y_n}$  ketma-ketlik cheksiz katta ketma-ketlik bo'ladi.

Isbot. a)  $\varepsilon$  – ixtiyoriy musbat son,  $\{x_n\}$  esa cheksiz katta ketma-ketlik bo'lsin. Nolning  $\frac{1}{\varepsilon}$ -atrofini olamiz.  $\{x_n\}$  ketma-ketlik cheksiz katta ketma-ketlik bo'lgani uchun shunday  $N = N\left(\frac{1}{\varepsilon}\right)$  natural son topiladiki, barcha  $n \geq N$  natural sonlar uchun  $|x_n| = \frac{1}{|y_n|} > \frac{1}{\varepsilon}$ , ya'ni  $|y_n| < \varepsilon$  tengsizlik bajariladi.

Demak, ixtiyoriy  $\varepsilon > 0$  son uchun shunday  $N$  natural son topiladiki, barcha  $n \geq N$  lar uchun  $|y_n| < \varepsilon$  bo'ladi. Bu esa  $\{y_n\}$  ning cheksiz kichikligini bildiradi.

b)  $E$  – ixtiyoriy musbat son,  $\{y_n\}$  esa cheksiz kichik ketma-ketlik bo'lsin.  $\{y_n\}$  ketma-ketlik cheksiz kichik ketma-ketlik bo'lgani uchun  $\frac{1}{E} > 0$  songa bog'liq bo'lgan shunday  $N = N\left(\frac{1}{E}\right)$  natural son topiladiki, barcha  $n \geq N$  natural sonlarda  $|y_n| = \frac{1}{|x_n|} < \frac{1}{E}$  yoki  $|x_n| > E$  tengsizlik bajariladi. Bu esa  $\{x_n\}$  ketma-ketlikning cheksiz katta ketma-ketlik ekanini bildiradi.

2 - misol.  $x_n = \frac{1}{n^\alpha} > 0$  (bu yerda  $\alpha > 0$ ) ketma-ketlik cheksiz kichik ketma-ketlik ekanligini isbotlaymiz.

Isbot.  $y_n = n^\alpha$  ( $\alpha > 0$ ) ketma-ketlikning cheksiz katta ketma-ketlik ekanligini isbotlaymiz.  $E$  ixtiyoriy musbat son bo'lsin.

$|y_n| = n^\alpha \geq E$  tengsizlikdan  $n \geq E^{\frac{1}{\alpha}}$  ni topamiz.  $N = \left[ E^{\frac{1}{\alpha}} \right] + 1$  deb

olsak, barcha  $n \geq N$  larda

$$|y_n| = n^\alpha \geq N^\alpha = \left( \left[ E^{\frac{1}{\alpha}} \right] + 1 \right)^\alpha > \left( \left[ E^{\frac{1}{\alpha}} \right] + \left\{ E^{\frac{1}{\alpha}} \right\} \right)^\alpha = \left( E^{\frac{1}{\alpha}} \right)^\alpha = E$$

tengsizlik bajariladi. Demak,  $\{y_n\}$  cheksiz katta ketma-ketlik. U

holda isbotlangan teoreмага ko'ra  $x_n = \frac{1}{n^\alpha}$  ketma-ketlik cheksiz kichik ketma-ketlikdir.

Cheksiz katta ketma-ketlikning aniqlanishidan uning chegaralanmaganligi kelib chiqadi. Chegaralanmagan ketma-ketlik cheksiz katta ketma-ketlik bo'lishi shart emas. Masalan, 1, 0, 2, 0, 3, 0, 4, 0, 5, 0, 6, 0, 7, ... ketma-ketlik chegaralanmagan ketma-ketlik bo'lib, u cheksiz katta ketma-ketlik bo'la olmaydi.

$\{x_n\}$  ketma-ketlikning cheksiz katta ketma-ketlik ekanligini  $x_n \rightarrow \infty$  ko'rinishida belgilaymiz.

Agar  $\{x_n\}$  cheksiz katta ketma-ketlikning biror hadidan boshlab barcha hadlari musbat (manfiy) bo'lsa, buni  $x_n \rightarrow +\infty$  (mos ravishda  $x_n \rightarrow -\infty$ ) ko'rinishida belgilaymiz.

1-misolda va 2-misolda qaralgan  $\{x_n\}$  ketma-ketliklar uchun  $x_n \rightarrow +\infty$  munosabat bajariladi.  $x_n = -n$  ketma-ketlik uchun esa  $x_n \rightarrow -\infty$  munosabatga ega bo'lamiz.

$z_n = (-1)^n \cdot n$  ketma-ketlik uchun  $z_n \rightarrow \infty$  bo'lib,  $z_n \rightarrow +\infty$ ,  $z_n \rightarrow -\infty$  larning hech biri o'rinli emas.



## Mashqlar

**3.25.** Ketma-ketlikning cheksiz katta ketma-ketlik ekanligini isbotlang:

1)  $x_n = n^2 + 1$ ;

2)  $x_n = n - 1$ ;

3)  $x_n = 3n - 4$ ;

4)  $x_n = \frac{n^2 + 1}{n - 1}$ .

**3.26.** Ketma-ketlik  $+\infty$ ,  $-\infty$  va  $\infty$  lardan qaysi biriga intiladi:

1)  $x_n = 1 - n^2$ ;

2)  $x_n = n^2 + 3n + 1$ ;

3)  $x_n = (-1)^n n^3$ ;

4)  $x_n = \frac{1}{n}$  ?

**4. Ketma-ketlikning limiti.**  $\{x_n\}$  ketma-ketlik va  $a$  haqiqiy son berilgan bo'lsin. Agar  $\alpha_n = x_n - a$  ketma-ketlik cheksiz kichik ketma-ketlik bo'lsa,  $a$  son  $\{x_n\}$  ketma-ketlikning *limiti* deyiladi va  $\lim_{n \rightarrow \infty} x_n = a$  ko'rinishida belgilanadi.

1-misol.  $\lim_{n \rightarrow \infty} \frac{2n+1}{n} = 2$  ekanligini isbotlaymiz.

Isbot.  $\alpha_n = \frac{2n+1}{n} - 2 = \frac{1}{n}$  ketma-ketlik cheksiz kichik ketma-

ketlikdir (qarang, 1-band). Ta'rifga ko'ra  $\lim_{n \rightarrow \infty} \frac{2n+1}{n} = 2$ .

**1-teorema.** Agar  $\lim_{n \rightarrow \infty} x_n = a$  bo'lsa, u holda  $\{x_n\}$  ketma-ketlik  $a$  son bilan cheksiz kichik ketma-ketlikning yig'indisi ko'rinishida tasvirlanadi va aksincha, agar  $x_n$  ketma-ketlikni  $a$  soni bilan cheksiz ketma-ketlikning yig'indisi ko'rinishida tasvirlash mumkin bo'lsa, u holda  $\lim_{n \rightarrow \infty} x_n = a$  bo'ladi.

Isbot.  $\lim_{n \rightarrow \infty} x_n = a$  bo'lsin. U holda  $\alpha_n = x_n - a$  ketma-ketlik cheksiz kichik ketma-ketlikdir.  $\alpha_n = x_n - a$  tenglikdan  $x_n = a + \alpha_n$  tenglikni hosil qilamiz. Demak, agar  $\lim_{n \rightarrow \infty} x_n = a$  bo'lsa,  $\{x_n\}$  ketma-ketlikni  $a$  son bilan cheksiz kichik ketma-ketlikning yig'indisi ko'rinishida tasvirlash mumkin.

Endi  $x_n = a + \alpha_n$  bo'lsin, bu yerda  $\alpha_n$  — cheksiz kichik ketma-ketlik. U holda  $\alpha_n = x_n - a$  tenglikka ega bo'lamiz. Ketma-ketlik limitining ta'rifiga ko'ra  $\lim_{n \rightarrow \infty} x_n = a$  tenglik o'rinlidir.

**1-natija.**  $\alpha_n$  ketma-ketlik cheksiz kichik bo'lsa,  $\lim_{n \rightarrow \infty} \alpha_n = 0$  bo'ladi.

**2-natija.** O'zgarmas ketma-ketlikning limiti o'ziga teng:  $\lim_{n \rightarrow \infty} a = a$ .

Isbot.  $a = a + 0$  bo'lgani uchun 1-teoremaga ko'ra,  $\lim_{n \rightarrow \infty} a = a$ .

**2-misol.**  $\lim_{n \rightarrow \infty} \frac{2n+1}{3n} = \frac{2}{3}$  ekanini isbotlang.

Isbot.  $\frac{2n+1}{3n} = \frac{2}{3} + \frac{1}{3n}$  tenglikka egamiz.  $\alpha_n = \frac{1}{3} \cdot \frac{1}{n}$  ketma-ketlik o'zgarmas son bilan cheksiz kichik ketma-ketlikning ko'paytmasi sifatida cheksiz kichik ketma-ketlikdir. Shu sababli isbotlangan 1-teoremaga ko'ra  $\lim_{n \rightarrow \infty} \frac{2n+1}{3n} = \frac{2}{3}$  tenglik o'rinlidir.

**2-teorema.** Agar  $\{x_n\}$  ketma-ketlik limitga ega bo'lsa, bu limit yagonadir.

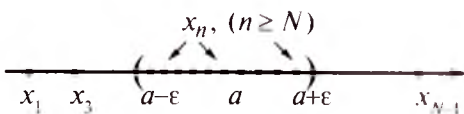

III.2-rasm.

**I s b o t .**  $\lim_{n \rightarrow \infty} x_n = a$ ,  $\lim_{n \rightarrow \infty} x_n = b$  bo'lsin. 1-teoremaga ko'ra  $x_n = a + \alpha_n$  ( $\alpha_n$  — cheksiz kichik ketma-ketlik),  $x_n = b + \beta_n$  ( $\beta_n$  — cheksiz kichik ketma-ketlik) tengliklar o'rinli.

Bulardan,  $0 = x_n - x_n = a - b + (\alpha_n - \beta_n)$  tenglikka ega bo'lamiz.  $\alpha_n - \beta_n$  ketma-ketlik cheksiz kichikdir. 1-teoremaga ko'ra oxirgi tenglikdan  $\lim_{n \rightarrow \infty} 0 = a - b$  munosabatni hosil qilamiz. 2-natijaga ko'ra  $a - b = 0$ , ya'ni  $a = b$ .

**3 - t e o r e m a .** Agar ketma-ketlik limitga ega bo'lsa, u holda u chegaralangan ketma-ketlik bo'ladi.

**I s b o t .**  $\lim_{n \rightarrow \infty} x_n = a$  bo'lsin. U holda  $\varepsilon = 1$  son uchun shunday  $N$  natural son topiladiki, barcha  $n \geq N$  lar uchun  $|x_n| - |a| \leq |x_n - a| < 1$  yoki  $|x_n| < 1 + |a|$  tengsizlik bajariladi.

$|x_1|$ ,  $|x_2|$ , ...,  $|x_{n-1}|$  sonlarning eng kattasini  $m$  bilan,  $1 + |a|$  va  $m$  sonlarning eng kattasini esa  $M$  bilan belgilaymiz. U holda quyidagilarga ega bo'lamiz:

$$\begin{aligned} |x_1| &\leq m \leq M, \\ |x_2| &\leq m \leq M, \\ &\dots \\ |x_{n-1}| &\leq m \leq M, \\ |x_n| &< 1 + |a| \leq M \quad (n \geq N). \end{aligned}$$

Demak, barcha  $n$  natural sonlar uchun  $|x_n| < M$  tengsizlik bajariladi, ya'ni  $\{x_n\}$  chegaralangan ketma-ketlikdir.

$\alpha_n = x_n - a$  ketma-ketlikning cheksiz kichik bo'lishligi ta'rifini yozib, ketma-ketlik limiti ta'rifining boshqacha ko'rinishiga kelamiz:

Agar ixtiyoriy  $\varepsilon > 0$  son uchun, shunday bir  $N = N(\varepsilon)$  natural son topilib, barcha  $n \geq N$  natural sonlarda  $|x_n - a| < \varepsilon$  tengsizlik bajarilsa,  $a$  son  $\{x_n\}$  ketma-ketlikning *limiti* deyiladi.



$|x_n - a| < \varepsilon$  tengsizlikni  $a - \varepsilon < x_n < a + \varepsilon$  ko'rishda yozib olish mumkin. Bu yerdan ko'rinadiki, agar  $\lim_{n \rightarrow \infty} x_n = a$  bo'lsa,  $a$  ning ixtiyoriy  $\varepsilon$ -atrofini olmaylik,  $\{x_n\}$  ketma-ketlikning biror  $x_N$  hadidan boshlab barcha hadlari shu atrofda yotadi (III.2-rasm).



## Mashqlar

**3.27.** Ketma-ketlikni o'zgarmas son bilan cheksiz kichik ketma-ketlikning yig'indisi shaklida tasvirlang va limitini toping:

$$1) x_n = \frac{2n+5}{n+2};$$

$$2) x_n = \frac{n^2-n}{n^3};$$

$$3) x_n = \frac{3n^2-4}{n^2-1};$$

$$4) x_n = \frac{n^4+2n^2+1}{(n^2+1)(n^3-1)}.$$

**3.28.** Isbotlang:

$$1) \lim_{n \rightarrow \infty} \frac{2n^2+n}{4n^2+1} = \frac{1}{2};$$

$$2) \lim_{n \rightarrow \infty} \frac{3n-1}{4n+2} = \frac{3}{4};$$

$$3) \lim_{n \rightarrow \infty} \frac{n^2-1}{n^2+1} = 1;$$

$$4) \lim_{n \rightarrow \infty} \frac{n}{2n+1} = \frac{1}{2};$$

$$5) \lim_{n \rightarrow \infty} \frac{2n}{n+1} = 2;$$

$$6) \lim_{n \rightarrow \infty} \frac{1-(-1)^n}{n} = 0;$$

$$7) \lim_{n \rightarrow \infty} \frac{\sin n}{n} = 0;$$

$$8) \lim_{n \rightarrow \infty} \frac{n-n^2}{2n^2+3} = -\frac{1}{2}.$$

**5. Limitlar haqida asosiy teoremlar.** Oldingi bandlarda ketma-ketlikning limitini hisoblash haqidagi masala ochiq qolgan edi. Endi shu masalaga qaytamiz.

**1-teorema.** Agar  $\lim_{n \rightarrow \infty} x_n = a$ ,  $\lim_{n \rightarrow \infty} y_n = b$  bo'lsa, u holda  $\{x_n + y_n\}$  ketma-ketlik ham limitga ega va  $\lim_{n \rightarrow \infty} (x_n + y_n) = a + b = \lim_{n \rightarrow \infty} x_n + \lim_{n \rightarrow \infty} y_n$  tenglik o'rinli.

**Isbot.**  $\lim_{n \rightarrow \infty} x_n = a$ ,  $\lim_{n \rightarrow \infty} y_n = b$  bo'lgani uchun  $\alpha_n = x_n - a$  va  $\beta_n = y_n - b$  ketma-ketliklar cheksiz kichik ketma-ketlikdir. U holda

cheksiz kichik  $\alpha_n$  va  $\beta_n$  ketma-ketliklarning yig'indisi sifatida  $\gamma_n = (x_n + y_n) - (a + b)$  ketma-ketlik ham cheksiz kichik ketma-ketlikdir. Shu sababli,

$$\lim_{n \rightarrow \infty} (x_n + y_n) = a + b = \lim_{n \rightarrow \infty} x_n + \lim_{n \rightarrow \infty} y_n.$$

**2-teorema.** Agar  $\lim_{n \rightarrow \infty} x_n = a$ ,  $\lim_{n \rightarrow \infty} y_n = b$  bo'lsa, u holda  $\{x_n y_n\}$  ketma-ketlik limitga ega va  $\lim_{n \rightarrow \infty} (x_n y_n) = ab = \lim_{n \rightarrow \infty} x_n \cdot \lim_{n \rightarrow \infty} y_n$  tenglik bajariladi.

**Isbot.**  $\lim_{n \rightarrow \infty} x_n = a$ ,  $\lim_{n \rightarrow \infty} y_n = b$  bo'lgani uchun  $\alpha_n = x_n - a$  va  $\beta_n = y_n - b$  ketma-ketliklar cheksiz kichik ketma-ketliklardir. Shu sababli cheksiz kichik ketma-ketliklar yig'indisi bo'lgan  $x_n y_n - ab = a\beta_n + b\alpha_n + \alpha_n \beta_n$  ketma-ketlik cheksiz kichik ketma-ketlikdir. Demak,

$$\lim_{n \rightarrow \infty} (x_n y_n) = ab = \lim_{n \rightarrow \infty} x_n \cdot \lim_{n \rightarrow \infty} y_n.$$

**3-teorema.** Agar  $\lim_{n \rightarrow \infty} x_n = a$ ,  $\lim_{n \rightarrow \infty} y_n = b$  bo'lib,  $b \neq 0$  bo'lsa, u holda  $\left\{ \frac{x_n}{y_n} \right\}$  ketma-ketlik  $n$  ning biror qiymatidan boshlab ma'noga ega va  $\lim_{n \rightarrow \infty} \frac{x_n}{y_n} = \frac{a}{b}$  bo'ladi.

Bu teoremaning isboti oldingi teoremlarning isbotiga qaraganda qiyinroq bo'lgani uchun uni keltirmaymiz, lekin limitlarni hisoblash jarayonida undan keng foydalanamiz.

Keltirilgan teoremlardan quyidagi natijalar kelib chiqadi.

1-natija.  $\lim_{n \rightarrow \infty} (x_n - y_n) = \lim_{n \rightarrow \infty} x_n - \lim_{n \rightarrow \infty} y_n.$

2-natija.  $\lim_{n \rightarrow \infty} (cx_n) = c \cdot \lim_{n \rightarrow \infty} x_n$ , ( $c = \text{const}$ ).

3-natija.  $\lim_{n \rightarrow \infty} (x_n)^k = \left( \lim_{n \rightarrow \infty} x_n \right)^k$ , ( $k$  — natural son).

**4-teorema.** Agar  $x_n \leq y_n \leq z_n$  bo'lib,  $\lim_{n \rightarrow \infty} x_n = \lim_{n \rightarrow \infty} z_n = a$  bo'lsa,  $\lim_{n \rightarrow \infty} y_n = a$  bo'ladi.

Isbot.  $\lim_{n \rightarrow \infty} y_n = a$  va  $\lim_{n \rightarrow \infty} z_n = a$  bo'lgani uchun  $x_n = a + \alpha_n$ ,  $z_n = a + \beta_n$  tengliklar bajariladi, bu yerda  $\alpha_n, \beta_n$  — cheksiz kichik ketma-ketliklardir. Shu sababli,  $a + \alpha_n \leq y_n \leq a + \beta_n$  yoki  $\alpha_n \leq y_n - a \leq \beta_n$  tengsizlik o'rinlidir.

$\varepsilon$  ixtiyoriy musbat son bo'lsin.  $\alpha_n$  cheksiz kichik ketma-ketlik bo'lgani uchun shunday  $N_1$  natural son topiladiki, barcha  $n \geq N_1$  natural sonlar uchun  $\alpha_n > -\varepsilon$  tengsizlik bajariladi.

$\beta_n$  cheksiz kichik ketma-ketlik bo'lgani uchun shunday  $N_2$  natural son topiladiki, barcha  $n \geq N_2$  natural sonlar uchun  $\beta_n < \varepsilon$  tengsizlik bajariladi.

$N_1$  va  $N_2$  natural sonlardan katta bo'lgan  $N$  natural son olaylik. U holda barcha  $n \geq N$  lar uchun  $\alpha_n > -\varepsilon$ ,  $\beta_n < \varepsilon$  tengsizliklar bir vaqtda bajariladi. Aynan shu  $n \geq N$  lar uchun  $-\varepsilon < \alpha_n \leq y_n - a \leq \beta_n < \varepsilon$  tengsizlikka ega bo'lamiz. Demak, ixtiyoriy  $\varepsilon > 0$  son uchun, shunday  $N$  natural son topiladiki, barcha  $n \geq N$  lar uchun  $-\varepsilon < y_n - a < \varepsilon$  yoki baribir  $|y_n - a| < \varepsilon$  tengsizlik bajariladi. Bu esa  $\lim_{n \rightarrow \infty} y_n = a$  ekanligini tasdiqlaydi.

1-misol.  $\lim_{n \rightarrow \infty} \frac{2n^2 + 3n - 1}{3n^2 - 5n + 4}$  ni hisoblang.

Yechish. Keltirilgan teoremlardan va natijalardan foydalanamiz:

$$\begin{aligned} \lim_{n \rightarrow \infty} \frac{2n^2 + 3n - 1}{3n^2 - 5n + 4} &= \lim_{n \rightarrow \infty} \frac{2 + \frac{3}{n} - \frac{1}{n^2}}{3 - \frac{5}{n} + \frac{4}{n^2}} = \frac{\lim_{n \rightarrow \infty} \left( 2 + \frac{3}{n} - \frac{1}{n^2} \right)}{\lim_{n \rightarrow \infty} \left( 3 - \frac{5}{n} + \frac{4}{n^2} \right)} = \\ &= \frac{\lim_{n \rightarrow \infty} 2 + \lim_{n \rightarrow \infty} \frac{3}{n} - \lim_{n \rightarrow \infty} \frac{1}{n^2}}{\lim_{n \rightarrow \infty} 3 - \lim_{n \rightarrow \infty} \frac{5}{n} + \lim_{n \rightarrow \infty} \frac{4}{n^2}} = \frac{2 + 3 \lim_{n \rightarrow \infty} \frac{1}{n} - \lim_{n \rightarrow \infty} \frac{1}{n^2}}{3 - 5 \lim_{n \rightarrow \infty} \frac{1}{n} + 4 \lim_{n \rightarrow \infty} \frac{1}{n^2}} = \frac{2 + 3 \cdot 0 - 0}{3 - 5 \cdot 0 + 4 \cdot 0} = \frac{2}{3}. \end{aligned}$$

2-misol.  $\lim_{n \rightarrow \infty} (\sqrt{n+1} - \sqrt{n})$  ni hisoblaymiz.

Yechish.  $\lim_{n \rightarrow \infty} (\sqrt{n+1} - \sqrt{n}) = \lim_{n \rightarrow \infty} \frac{(\sqrt{n+1} - \sqrt{n})(\sqrt{n+1} + \sqrt{n})}{\sqrt{n+1} + \sqrt{n}} =$

$$= \lim_{n \rightarrow \infty} \frac{n+1-n}{\sqrt{n+1}+\sqrt{n}} = \lim_{n \rightarrow \infty} \frac{1}{\sqrt{n+1}+\sqrt{n}} = \lim_{n \rightarrow \infty} \frac{\frac{1}{\sqrt{n}}}{\sqrt{1+\frac{1}{n}}+1} = \frac{\lim_{n \rightarrow \infty} \frac{1}{\sqrt{n}}}{\lim_{n \rightarrow \infty} \sqrt{1+\frac{1}{n}} + \lim_{n \rightarrow \infty} 1} =$$

$$= \frac{0}{\sqrt{1+0}+1} = 0.$$

3 - misol.  $\lim_{n \rightarrow \infty} (n^6 + 2n^5 + 3n^2 + 1) =$

$$= \lim_{n \rightarrow \infty} \left( n^6 \left( 1 + \frac{2}{n} + \frac{3}{n^4} + \frac{1}{n^6} \right) \right) = +\infty.$$

4 - misol.  $\lim_{n \rightarrow \infty} q^n = 0$ , ( $|q| < 1$ ) ekanini isbotlaymiz.

Isbot.  $|q| = \frac{1}{1+\alpha}$  bo'lsin, bu yerda  $\alpha > 0$ .  $x_n = 0$ ,  $y_n = |q|^n$ ,  $z_n = \frac{1}{1+n\alpha}$  ketma-ketliklarni qaraymiz. Ular uchun  $x_n \leq y_n \leq z_n$  tengsizlik o'rinlidir. Haqiqatan ham,

$$0 < |q|^n = \frac{1}{(1+\alpha)^n} = \frac{1}{1+n\alpha+(\text{musbat qo'sh.})} < \frac{1}{1+n\alpha} = z_n.$$

$\lim_{n \rightarrow \infty} x_n = \lim_{n \rightarrow \infty} z_n = 0$  bo'lgani uchun  $\lim_{n \rightarrow \infty} |q|^n = 0$ .

Demak, ixtiyoriy  $\varepsilon > 0$  son uchun shunday  $N = N(\varepsilon)$  natural son topiladiki,  $|q|^n = |q^n| < \varepsilon$  tengsizlik bajariladi. Bu esa  $\lim_{n \rightarrow \infty} q^n = 0$  ekanligini bildiradi.

## Mashqlar

**3.29.**  $\{a_n\}$  va  $\{b_n\}$  ketma-ketliklar uchun  $|a_n| \leq |b_n|$  ( $n = 1, 2, 3, \dots$ ) va  $\lim_{n \rightarrow \infty} b_n = 0$  bo'lsin. U holda  $\lim_{n \rightarrow \infty} a_n = 0$  bo'lishini isbotlang.

**3.30.** Limitni hisoblang:

1)  $\lim_{n \rightarrow \infty} \frac{2n+1}{n+1};$

2)  $\lim_{n \rightarrow \infty} \frac{n^3-3n^2+2}{3n^4-5n^3+8};$

3)  $\lim_{n \rightarrow \infty} (n^5 - 21n^2 + 3n - 4);$

4)  $\lim_{n \rightarrow \infty} \frac{n^3+n}{2n^2-2n+1};$

$$5) \lim_{n \rightarrow \infty} (\sqrt{n^2 + 1} - \sqrt{n^2 - 1}); \quad 6) \lim_{n \rightarrow \infty} \frac{3n^2 - 4}{5n^3 + n^2};$$

$$7) \lim_{n \rightarrow \infty} \frac{3n+1}{9n^2 - 10n^2 - 8}; \quad 8) \lim_{n \rightarrow \infty} \frac{\sqrt{n^2 - 5}}{\sqrt{n^2 - 5}}.$$

**3.31. Ketma-ketlikning limitini toping:**

$$1) x_n = \frac{1+a+a^2+\dots+a^n}{1+b+b^2+\dots+b^n}, \quad (|a| < 1, |b| < 1);$$

$$2) y_n = \frac{n\sqrt{1+3+5+\dots+(2n-1)}}{2n^2+n+1};$$

$$3) z_n = \sqrt[n]{3^n + 5^n};$$

$$4) z_n = \frac{3^n + 2^n}{3^n - 2^n};$$

$$5) x_n = \frac{\sqrt{n+1}}{\sqrt{n+1}};$$

$$6) y_n = \frac{1+2+3+\dots+n}{n^2};$$

$$7) x_n = \frac{\sqrt[3]{n^3+n}}{n+1};$$

$$8) y_n = \sqrt[n]{1+2^n}.$$

**3.32. Limitlarni toping.**

$$1) \lim_{n \rightarrow \infty} \left( \frac{1}{1 \cdot 2} + \frac{1}{2 \cdot 3} + \dots + \frac{1}{(n-1)n} \right); \quad 2) \lim_{n \rightarrow \infty} \frac{\frac{1}{2^n} - 1}{\frac{1}{2^{n+1}}};$$

$$3) \lim_{n \rightarrow \infty} (\sqrt[3]{n+2} - \sqrt[3]{n}); \quad 4) \lim_{n \rightarrow \infty} (\sqrt[4]{n^2+3n} - \sqrt[3]{n-3}).$$

**6. Monoton ketma-ketlikning limiti haqidagi teorema.** Matematik analizning muhim teoremlaridan birini keltiramiz.

*Veyershtross teoremasi. Agar kamaymaydigan (o'smaydigan)  $\{x_n\}$  ketma-ketlik yuqoridan (quyidan) chegaralangan bo'lsa, u holda bu ketma-ketlik limitga ega bo'ladi.*

Bu teorema oliy matematika kursida isbotlanadi. Biz bu teoremaning tatbiqiga doir ayrim misollar qarash bilan chegaralanamiz.

1 - misol.  $y_n = \left(1 + \frac{1}{n}\right)^n$  ketma-ketlikning limiti mavjudligini ko'rsatamiz. Shu maqsadda  $x_n = \left(1 + \frac{1}{n}\right)^{n+1}$  ketma-ketlikni qaraymiz.  $x_n$  ketma-ketlik quyidan chegaralangan ketma-ketlikdir:  $x_n > 0$ . Uning o'smaydigan ketma-ketlik ekanligi 1-§, 3-band, 4-misolda ko'rsatilgan.

Veyersstrass teoremasiga ko'ra  $\{x_n\}$  ketma-ketlik limitga ega:

$$\lim_{n \rightarrow \infty} \left(1 + \frac{1}{n}\right)^n = \lim_{n \rightarrow \infty} \frac{\left(1 + \frac{1}{n}\right)^n}{1 + \frac{1}{n}} = \frac{\lim_{n \rightarrow \infty} \left(1 + \frac{1}{n}\right)^{n+1}}{\lim_{n \rightarrow \infty} \left(1 + \frac{1}{n}\right)} = \lim_{n \rightarrow \infty} \left(1 + \frac{1}{n}\right)^{n+1}$$

tenglikdan,  $\lim_{n \rightarrow \infty} \left(1 + \frac{1}{n}\right)^n$  limitning ham mavjudligi kelib chiqadi.

Bu limit  $e$  harfi orqali belgilanadi:

$$\lim_{n \rightarrow \infty} \left(1 + \frac{1}{n}\right)^n = e, \quad (e \approx 2,71828), \quad (1)$$

( $e = 2,7182818284\dots$ ).

$e$  son irratsional son ekanligi, shuningdek, uning hech bir butun koeffitsiyentli algebraik tenglamaning ildizi bo'la olmasligi, ya'ni *transsendent* son ekanligi isbotlangan. (1) limit ko'pgina matematik tadqiqotlarning asosida yotuvchi ajoyib limitlarning biridir.  $e$  son matematikada alohida ahamiyatga egadir. Bunga siz oliy matematika bilan shug'ullanganingizda ishonch hosil qilasiz.

2 - misol. Mamlakat aholisi yiliga 2% o'sadi. 100 yilda mamlakat aholisi necha marta ortadi?

Y e c h i s h.  $A$  bilan mamlakat aholisining dastlabki sonini belgilasak, bir yildan keyin aholi soni  $A + \left(\frac{A}{100}\right) \cdot 2 = \left(1 + \frac{1}{50}\right) \cdot A$  ga teng bo'ladi. Ikki yildan keyin aholi soni  $A \cdot \left(1 + \frac{1}{50}\right)^2$  ga, yuz yildan keyin esa  $A \cdot \left(1 + \frac{1}{50}\right)^{100}$  ga teng bo'ladi, ya'ni yuz yildan keyin aholi soni  $A \cdot \left(1 + \frac{1}{50}\right)^{100} = \left(\left(1 + \frac{1}{50}\right)^{50}\right)^2$  marta ortadi.

$\lim_{n \rightarrow \infty} \left(1 + \frac{1}{n}\right)^n = e$  ekanligini e'tiborga olib,  $\left(1 + \frac{1}{50}\right)^{50} \approx e$  deb hisoblashimiz mumkin. Demak, mamlakat aholisi soni yuz yildan keyin taxminan  $e^2 \approx 7,89$  marta ortadi.



**3.33.**  $a_n = \frac{\sqrt{2 + \sqrt{2 + \sqrt{2 + \dots + \sqrt{2}}}}}{n \text{ ta ildiz}}$  ketma-ketlikning limitini toping.

**3.34.** Rekurrent usulda berilgan ketma-ketlikning limitga ega ekanligini isbotlang va limitini toping:

1)  $a_1 = \frac{1}{2}$ ,  $a_{n+1} = \frac{1}{2-a_n}$ ; 2)  $a_1 = \frac{1}{2}$ ,  $a_{n+1} = \frac{2}{3-a_n}$ .

**3.35.** Ketma-ketlik  $n$  - hadining formulasini toping va shu ketma-ketlikning limitini hisoblang:

1)  $a_1 = 3$ ,  $a_{n+1} = \frac{a_n + 1}{2}$ , ( $n \geq 2$ );

2)  $a_1 = 1$ ,  $a_2 = \frac{5}{2}$ ,  $a_n = \frac{3}{2}a_{n-1} - \frac{1}{2}a_{n-2}$ , ( $n \geq 3$ ).



# IV BOB

## FUNKSIYANING LIMITI VA UZLUKSIZLIGI

### 1-§. Funksiyaning limiti

#### 1. Funksiyaning nuqtadagi bir tomonlama limiti.

$$y = f(x) = \begin{cases} (x-1)^2 + 0,5, & \text{agar } x \leq 1 \text{ bo'lsa,} \\ 3-x, & \text{agar } x > 1 \text{ bo'lsa,} \end{cases} \text{ funktsiya berilgan}$$

bo'lsin. Bu funktsiyaning qiymatlar jadvalini tuzamiz va uning grafigini (IV.1-rasm) yasaymiz:

x	0	0,5	0,6	0,7	0,8	0,9	1	1,1	1,2	1,3	1,5	2	3
y	1,5	0,75	0,66	0,59	0,54	0,51	0,5	1,9	1,8	1,7	1,5	1	0

Jadval va grafikni kuzatib,  $x$  argument 1 soniga chapdan yaqinlashganda funktsiyaning qiymatlari 0,5 sonidan, o'ng tomondan yaqinlashganda esa 2 sonidan istalgancha kam farq qiladi deb tasdiqlash mumkin.

0,5 soni berilgan  $y = f(x)$  funktsiyaning  $x = 1$  nuqtadagi chap limiti, 2 soni esa berilgan  $y = f(x)$  funktsiyaning  $x = 1$  nuqtadagi o'ng limiti deyiladi.

Funktsiya chap va o'ng limitlarining qat'iy matematik ta'rifini beramiz. Dastlab, chap limit ta'rifini keltiraylik.

$y = f(x)$  funktsiya va  $x = a$  nuqta berilgan bo'lsin. Agar ixtiyoriy  $\varepsilon > 0$  son uchun  $a$  dan kichik bo'lgan shunday bir  $N$  haqiqiy son topilib,  $N$  va  $a$  sonlar orasida yotuvchi barcha  $x$  lar uchun  $(N < x < a) |f(x) - b| < \varepsilon$  tengsizlik bajarilsa,  $b \in R$  son  $y = f(x)$  funktsiyaning  $x = a$  nuqtadagi (yoki  $x \rightarrow a$  dagi) *chap limiti* deyiladi.

Funksiyaning  $x \rightarrow a$  dagi chap limiti  $\lim_{x \rightarrow a-0} f(x) = b$  ko'rinishda

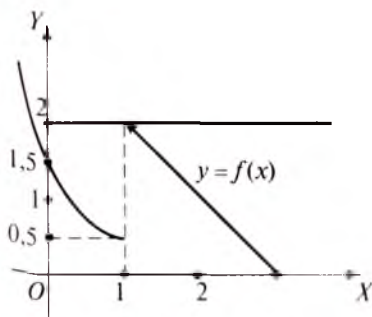

IV.1-rasm.



belgilanadi.  $x \rightarrow a - 0$  belgisi  $x$  ning  $a$  ga chapdan intilishini, ya'ni  $x$  argument  $a$  ga  $a$  dan kichik bo'lib intilishini bildiradi.

Yuqorida keltirilgan misoldan,  $\lim_{x \rightarrow 1-0} f(x) = 0,5$  ekanligi kelib chiqadi.

Funksiyaning  $x \rightarrow a$  dagi o'ng limiti tushunchasi ham  $x \rightarrow a$  dagi chap limiti tushunchasi kabi ta'riflanadi.

Agar  $\varepsilon > 0$  son uchun  $a$  dan katta bo'lgan shunday  $M$  haqiqiy son topilib,  $a$  va  $M$  sonlar orasida yotuvchi barcha  $x$  lar ( $a < x < M$ ) uchun  $|f(x) - b| < \varepsilon$  tengsizlik bajarilsa,  $b$  son  $y = f(x)$  funksiyaning  $x = a$  nuqtadagi (yoki  $x \rightarrow a$  dagi) o'ng limiti deyiladi va  $\lim_{x \rightarrow a+0} f(x) = b$  ko'rinishda belgilanadi.

Yuqorida qaralgan misoldan  $\lim_{x \rightarrow 1+0} f(x) = 2$  ga ega bo'lamiz.

Funksiyaning  $x \rightarrow a$  dagi chap limitining geometrik ma'nosi quyidagicha:

har qanday  $\varepsilon > 0$  son uchun  $a$  dan kichik shunday  $N$  son topiladiki,  $N$  va  $a$  sonlari orasida yotuvchi barcha  $x$  lar uchun funksiyaning grafiği  $y = b - \varepsilon$  va  $y = b + \varepsilon$  to'g'ri chiziqlar bilan chegaralangan yo'lakda yotadi (IV.2-a rasm).

Agar  $f(x)$  funksiyaning  $x \rightarrow a$  dagi o'ng limiti  $b$  songa teng bo'lsa, u holda uning geometrik ma'nosi quyidagicha bo'ladi:

har qanday  $\varepsilon > 0$  son uchun  $a$  dan katta shunday  $M$  son topiladiki,  $a$  va  $M$  sonlar orasida joylashgan barcha  $x$  lar uchun funksiyaning grafiği  $y = b - \varepsilon$  va  $y = b + \varepsilon$  to'g'ri chiziqlar bilan chegaralangan yo'lakda yotadi (IV.2-b rasm).

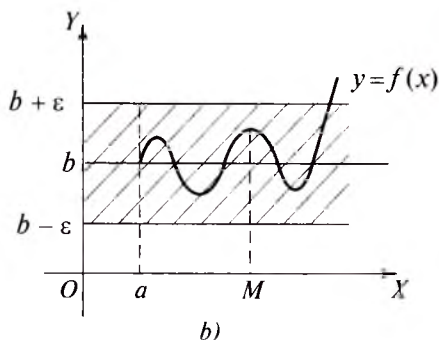
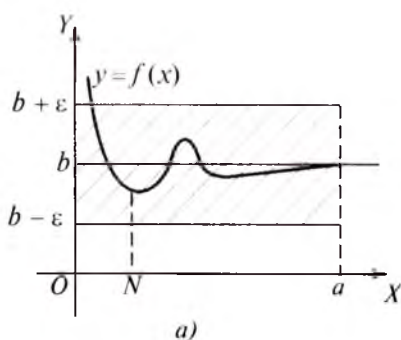

IV.2-rasm.

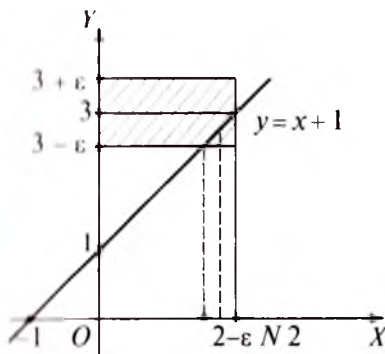

IV.3-rasm.

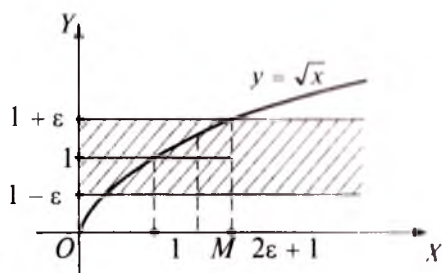

IV.4-rasm.

Funksiyaning  $x = a$  nuqtadagi chap va o'ng limitlari uning shu nuqtadagi *bir tomonlama limitlari* deyiladi.

1 - misol.  $\lim_{x \rightarrow 2-0} (x+1) = 3$  ekanligini isbotlang.

Isbot.  $\varepsilon$  ixtiyoriy musbat son va  $x < 2$  bo'lsin. U holda  $|f(x) - 3| = |x + 1 - 3| = |x - 2| = 2 - x < \varepsilon$  bo'lishi uchun  $2 - \varepsilon < x < 2$  bo'lishi yetarlidir. Demak, ta'rifdagi  $N$  son sifatida  $2 - \varepsilon$  sonni yoki  $2 - \varepsilon$  dan katta, lekin  $2$  dan kichik bo'lgan har qanday sonni olish mumkin. Bu esa  $\lim_{x \rightarrow 2-0} (x+1) = 3$  ekanligini ko'rsatadi (IV.3-rasm).

2 - misol.  $\lim_{x \rightarrow 1+0} \sqrt{x} = 1$  ekanligini isbotlaymiz.

Isbot.  $\varepsilon$  ixtiyoriy musbat son va  $x > 1$  bo'lsin. U holda

$$(f(x) - 1) = |\sqrt{x} - 1| = \left| \frac{x-1}{\sqrt{x}+1} \right| = \frac{x-1}{\sqrt{x}+1} < \frac{x-1}{2}$$

tengsizlik bajariladi. Bu yerdan ko'rinadiki,  $|f(x) - 1| < \varepsilon$  bo'lishi uchun  $\frac{x-1}{2} < \varepsilon$  va  $x > 1$  bo'lishi, ya'ni  $1 < x < 2\varepsilon + 1$  bo'lishi yetarlidir. Demak, ta'rifdagi  $M$  son sifatida  $(1; 2\varepsilon + 1)$  oraliqdagi har qanday sonni olish mumkin. Bu esa  $\lim_{x \rightarrow 1+0} \sqrt{x} = 1$  ekanligini ko'rsatadi (IV.4-rasm).

3 - misol.  $f(x) = \begin{cases} -2x + 3, & \text{agar } x \leq 1 \text{ bo'lsa,} \\ 3x - 5, & \text{agar } x > 1 \text{ bo'lsa} \end{cases}$  funksiyaning

$x \rightarrow 1$  dagi bir tomonlama limitlarini topamiz.

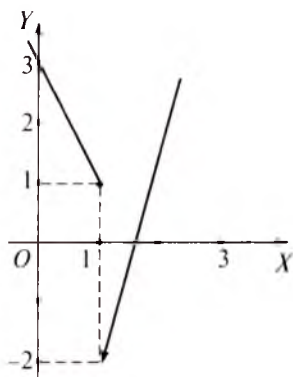

IV.5-rasm.

Yechish.  $x \leq 1$  bo'lsin. U holda,  $f(x) = -2x + 3$ . Demak,  $\lim_{x \rightarrow 1-0} f(x) =$   
 $= \lim_{x \rightarrow 1-0} (-2x + 3) = -2 \cdot 1 + 3 = 1$ .

Agar  $x > 1$  bo'lsa,  $f(x) = 3x - 5$  bo'lib,  
 $\lim_{x \rightarrow 1+0} f(x) = \lim_{x \rightarrow 1+0} (3x - 5) = 3 \cdot 1 - 5 = -2$   
 (IV.5-rasm).

IV.6- rasmda  $y = \frac{1}{x}$  funksiyaning grafigi tasvirlangan. Grafikni kuzatib,  $x$  argument 0 soniga chapdan (o'ngdan) yaqinlashganda funksiya qiymatlari  $-\infty$  ga (mos ravishda  $+\infty$  ga) yaqinlashadi deb tasdiqlash mumkin:  $\lim_{x \rightarrow 0-0} \frac{1}{x} = -\infty$ ,  $\lim_{x \rightarrow 0+0} \frac{1}{x} = +\infty$ .

Cheksiz chap limit va cheksiz o'ng limit tushunchalarining qat'iy matematik ta'rifini keltiramiz.

Agar ixtiyoriy  $E < 0$  ( $E > 0$ ) haqiqiy son uchun shunday  $N < a$  haqiqiy son topilib, barcha  $x \in (N; a)$  lar uchun  $f(x) < E$  (mos ravishda,  $f(x) > E$ ) tengsizlik bajarilsa,  $f(x)$  funksiyaning  $a$  nuqtadagi chap limiti  $-\infty$  (mos ravishda  $+\infty$ ) ga teng deyiladi va

$\lim_{x \rightarrow a-0} f(x) = -\infty$  (mos ravishda  $\lim_{x \rightarrow a-0} f(x) = +\infty$ ) ko'rinishda belgilanadi.

Agar ixtiyoriy  $E < 0$  ( $E > 0$ ) haqiqiy son uchun, shunday  $M < a$  haqiqiy son topilib, barcha  $x \in (a; M)$  lar uchun  $f(x) < E$  (mos ravishda  $f(x) > E$ ) tengsizlik bajarilsa,  $f(x)$  funksiya ning  $a$  nuqtadagi o'ng limiti  $-\infty$  (mos ravishda  $+\infty$ ) ga teng deyiladi va  $\lim_{x \rightarrow a+0} f(x) = -\infty$  (mos

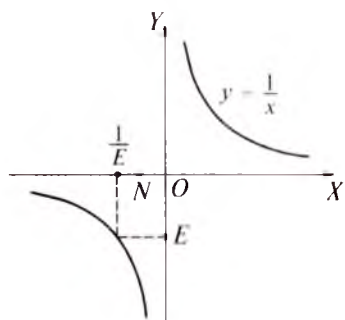

IV.6-rasm.

ravishda,  $\lim_{x \rightarrow a+0} f(x) = +\infty$ ) ko'rinishda belgilanadi.

4- misol.  $\lim_{x \rightarrow 0-0} \frac{1}{x} = -\infty$  tenglikni

isbotlang.

Isbot.  $E$  ixtiyoriy manfiy son va  $x < 0$  bo'lsin. U holda  $f(x) = \frac{1}{x} < E$  tengsizlik  $\frac{1}{E} < x < 0$  tengsizlikka teng kuchlidir. Bu yerdan ko'rinadiki, ta'rifda so'z borgan  $N$  son sifatida  $(\frac{1}{E}; 0)$  oraliqdagi har qanday sonni olish mumkin.

5-misol.  $\lim_{x \rightarrow 0+0} \frac{1}{x} = +\infty$  tenglikni isbotlang.

Isbot.  $E$  ixtiyoriy musbat son va  $x > 0$  bo'lsin. U holda  $f(x) = \frac{1}{x} > E$  tengsizlik  $0 < x < \frac{1}{E}$  tengsizlikka teng kuchlidir. Bu yerdan ko'rinadiki, ta'rifda so'z borgan  $M$  son sifatida  $(0; \frac{1}{E})$  oraliqdagi har qanday sonni olish mumkin.

Haqiqatan ham,  $M \in (0; \frac{1}{E})$  bo'lsin. U holda, barcha  $x \in (0; M)$  lar uchun  $f(x) = \frac{1}{x} > \frac{1}{M} > \frac{1}{E} = E$  tengsizlik bajariladi.

Demak,  $\lim_{x \rightarrow 0+0} \frac{1}{x} = +\infty$ .



## Mashqlar

4.1.  $\lim_{x \rightarrow a+0} f(x) = b$  ekanligini isbotlang, bunda:

- 1)  $f(x) = 4x - 2$ ,  $a = 1$ ,  $b = 2$ ; 2)  $f(x) = \sqrt{x^2}$ ,  $a = 0$ ,  $b = 0$ ;  
 3)  $f(x) = \sqrt{x}$ ,  $a = 9$ ,  $b = 3$ ; 4)  $f(x) = x^2 - 1$ ,  $a = 1$ ,  $b = 0$ .

4.2.  $\lim_{x \rightarrow a-0} f(x) = b$  ekanligini isbotlang, bunda:

- 1)  $f(x) = \begin{cases} x^2 - 1, & \text{agar } x > a \text{ bo'lsa,} \\ x + 1, & \text{agar } x < a \text{ bo'lsa,} \end{cases} \quad a = 2, b = 3$ ;  
 2)  $f(x) = \begin{cases} x^2 - 1, & \text{agar } x \leq a \text{ bo'lsa,} \\ x + 1, & \text{agar } x > a \text{ bo'lsa,} \end{cases} \quad a = 2, b = 1$ .

4.3.  $f(x)$  funksiyaning  $x = a$  nuqtadagi bir tomonlama limitlarini toping:

- 1)  $f(x) = \begin{cases} \sqrt{x}, & \text{agar } x > a \text{ bo'lsa,} \\ x + 4, & \text{agar } x \leq a \text{ bo'lsa,} \end{cases} \quad a = 4$ ;

$$2) f(x) = \begin{cases} \cos x, & \text{agar } x > a \text{ bo'lsa,} \\ \sin x, & \text{agar } x \leq a \text{ bo'lsa,} \end{cases} \quad a = \frac{\pi}{2}.$$

**2. Funksiyaning nuqtadagi limiti.**  $f(x) = x - 2$  funksiyaning  $x = 2$  nuqtadagi bir tomonlama limitini hisoblaymiz:

$$\lim_{x \rightarrow 2-0} f(x) = \lim_{x \rightarrow 2-0} (x - 2) = 2 - 2 = 0;$$

$$\lim_{x \rightarrow 2+0} f(x) = \lim_{x \rightarrow 2+0} (x - 2) = 2 - 2 = 0.$$

Bu yerda  $\lim_{x \rightarrow 2-0} f(x) = \lim_{x \rightarrow 2+0} f(x)$  ekanini ko'ramiz.

Agar  $\lim_{x \rightarrow a-0} f(x) = \lim_{x \rightarrow a+0} f(x) = b$  bo'lsa,  $b$  son  $f(x)$  funksiyaning  $x \rightarrow a$  dagi limiti deyiladi va  $\lim_{x \rightarrow a} f(x) = b$  ko'rinishda belgilanadi.

Shunday qilib, agar ixtiyoriy  $\varepsilon > 0$  son uchun shunday  $M$  va  $N$  sonlar topilib (bunda  $N < a < M$ ),  $(N; M)$  oraliqda yotuvchi barcha  $x$  lar uchun ( $a$  nuqta bundan mustasno bo'lishi mumkin)  $|f(x) - b| < \varepsilon$  tengsizlik bajarilsa,  $b \in \mathbb{R}$  son  $y = f(x)$  funksiyaning  $x \rightarrow a$  dagi limiti deyiladi.

1 - misol.  $\lim_{x \rightarrow 0} (x^2 + 2) = 2$  ekanini isbotlang.

Isbot.  $\lim_{x \rightarrow 0-0} (x^2 + 2) = 0^2 + 2 = 2$  va  $\lim_{x \rightarrow 0+0} (x^2 + 2) = 0^2 + 2 = 2$

bo'lgani uchun  $\lim_{x \rightarrow 0} (x^2 + 2) = 2$ .

2 - misol.  $\lim_{x \rightarrow 4} \sqrt{x} = 2$  ekanligini isbotlang.

Isbot.  $\varepsilon$  ixtiyoriy musbat son bo'lsin.  $x \geq 0$  bo'lgani uchun,

$$|f(x) - 2| = |\sqrt{x} - 2| = \left| \frac{x-4}{\sqrt{x}+2} \right| \leq \frac{|x-4|}{\sqrt{x}+2} \leq \frac{|x-4|}{2} < |x-4|$$

tengsizlik o'rinli. Demak,  $|f(x) - 2| < \varepsilon$  bo'lishi uchun  $|x - 4| < \varepsilon$  va  $x \geq 0$  bo'lishi, ya'ni  $4 - \varepsilon < x < 4 + \varepsilon$ ,  $x \geq 0$  bo'lishi yetarli. Bu yerdan ko'rinadiki, ta'rifdagi  $N$  son sifatida  $(4 - \varepsilon; 4)$  oraliqdagi har qanday musbat sonni,  $M$  son sifatida esa  $(4; 4 + \varepsilon)$  oraliq-

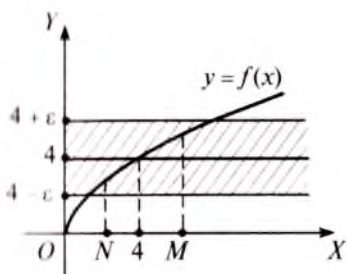

IV.7- rasm.

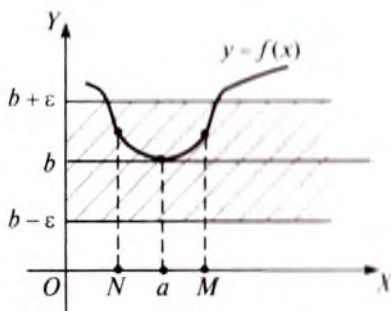

IV.8- rasm.

dagi har qanday sonni olish mumkin. Bu esa  $\lim_{x \rightarrow 4} \sqrt{x} = 2$  ekanligini bildiradi (IV.7-rasm).

$a$  nuqtani o'z ichiga olgan har qanday ochiq oraliqni uning *atrofi* deb ataymiz.  $(a - \delta; a + \delta)$  oraliq (bu yerda  $\delta > 0$ )  $a$  nuqtaning  $\delta$  - *atrofi*,  $\delta > 0$  son esa *atrofning radiusi* deb ataladi.

Agar  $b$  son  $y = f(x)$  funksiyaning  $x \rightarrow a$  dagi limiti bo'lsa, u holda  $|f(x) - b| < \varepsilon$  tengsizlik  $a$  nuqta biror atrofning barcha nuqtalari uchun ( $a$  nuqta bundan mustasno bo'lishi mumkin) bajarilishini ko'rish qiyin emas.  $\lim_{x \rightarrow a} f(x) = b$  ning geometrik ma'nosi IV.8-rasmdan ko'rinib turibdi:

3 - misol.  $[0; 4]$  kesmada quyidagicha aniqlangan  $y = f(x)$  funksiyani qaraymiz:

$$f(x) = \begin{cases} x - 1, & \text{agar } 0 \leq x \leq 3 \text{ bo'lsa,} \\ 3 - x, & \text{agar } 3 < x \leq 4 \text{ bo'lsa.} \end{cases}$$

Bu funksiyaning grafigi IV.9-rasmda tasvirlangan.

$$\lim_{x \rightarrow 3-0} f(x) = \lim_{x \rightarrow 3-0} (x - 1) = 3 - 1 = 2,$$

$$\lim_{x \rightarrow 3+0} (3 - x) = 3 - 0 = 3$$

tengliklardan ko'rinadiki,  $\lim_{x \rightarrow 3} f(x)$  limit mavjud emas.

Endi funksiyaning nuqtadagi cheksiz limitini qaraymiz. Agar  $y = f(x)$  funksiyaning  $x = a$  nuq-

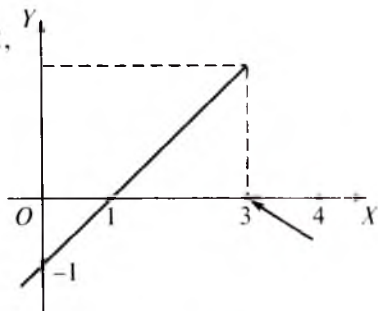

IV.9- rasm.

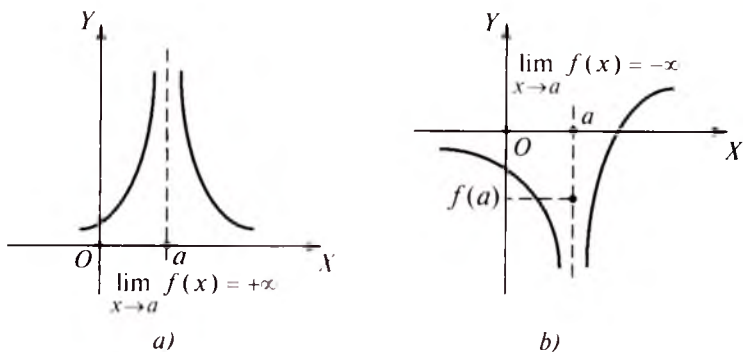

IV.10- rasm.

tadagi chap limiti ham, o'ng limiti ham  $+\infty$  ( $-\infty$ ) ga teng bo'lsa,  $f(x)$  funksiyaning  $x = a$  nuqtadagi limiti  $+\infty$  (mos ravishda  $-\infty$ ) ga teng deyiladi va  $\lim_{x \rightarrow a} f(x) = +\infty$  (mos ravishda  $\lim_{x \rightarrow a} f(x) = -\infty$ ) ko'rinishda belgilanadi (IV.10-rasm).

Agar  $\lim_{x \rightarrow a} f(x) = +\infty$  bo'lsa, ixtiyoriy  $E > 0$  son uchun shunday  $(N; a)$  va  $(a; M)$  intervallar topiladiki, bu intervallardagi barcha  $x$  lar uchun  $f(x) > E$  tengsizlik bajariladi.

Agar  $\lim_{x \rightarrow a} f(x) = -\infty$  bo'lsa, ixtiyoriy  $E < 0$  son uchun shunday  $(N; a)$  va  $(a; M)$  intervallar topiladiki, bu intervaldagi barcha  $x$  lar uchun  $f(x) < E$  tengsizlik bajariladi.

4 - misol.  $\lim_{x \rightarrow 0} \frac{1}{|x|} = +\infty$  ekanligini isbotlang.

Isbot.  $E$  ixtiyoriy musbat son va  $x \neq 0$  bo'lsin. U holda

$$f(x) = \frac{1}{|x|} > E \text{ tengsizlik } \begin{cases} -\frac{1}{E} < x < 0, \\ 0 < x < \frac{1}{E} \end{cases} \text{ tengsizliklar sistemasiga}$$

teng kuchlidir. Bu yerdan ko'rinadiki, ta'rifda so'z borgan  $N$  son sifatida  $(-\frac{1}{E}; 0)$  oraliqdagi,  $M$  son sifatida esa  $(0; \frac{1}{E})$  oraliqdagi har qanday sonni olish mumkin. U holda  $(N; M)$  oraliqdagi barcha  $x \neq 0$  sonlar uchun  $f(x) > E$  tengsizlik bajariladi. Demak,

$$\lim_{x \rightarrow 0} \frac{1}{|x|} = +\infty.$$

Agar  $\lim_{x \rightarrow a} f(x) = +\infty$  yoki  $\lim_{x \rightarrow a} f(x) = -\infty$  bo'lsa,  $f(x)$  funksiya  $x = a$  nuqtada ( $x \rightarrow a$  da) *aniq ishorali cheksiz limitga ega* deyiladi.

Agar  $f(x)$  funksiyaning  $x = a$  nuqtadagi bir tomonlama limitlarining biri  $+\infty$  ga, ikkinchisi esa  $-\infty$  ga teng bo'lsa,  $f(x)$  funksiya  $x = a$  nuqtada *aniqmas ishorali cheksiz limitga ega* deyiladi.

$y = \frac{1}{|x|}$  funksiya  $x = 0$  nuqtada aniq ishorali cheksiz limitga (4-misol) ega,  $y = \frac{1}{x}$  funksiya esa  $x = 0$  nuqtada aniqmas ishorali cheksiz limitga ega (1-band, 4–5-misollar).

$x = a$  nuqtada aniq ishorali yoki aniqmas ishorali cheksiz limitga ega bo'lgan  $f(x)$  funksiya shu nuqtada *cheksiz katta funksiya* deyiladi va  $\lim_{x \rightarrow a} f(x) = \infty$  ko'rinishda belgilanadi.

$y = \frac{1}{|x|}$ ,  $y = \frac{1}{x}$  funksiyalarning har biri  $x = 0$  nuqtada cheksiz katta funksiyalardir  $\left( \lim_{x \rightarrow a} \frac{1}{|x|} = +\infty, \lim_{x \rightarrow a} \frac{1}{x} = \infty \right)$ .

5-misol.  $f(x) = \begin{cases} 1, & \text{agar } x \leq 0 \text{ bo'lsa,} \\ \frac{1}{x}, & \text{agar } x > 0 \text{ bo'lsa} \end{cases}$  funksiyaning grafiği IV.11-rasmda tasvirlangan.  $\lim_{x \rightarrow 0-0} f(x) = \lim_{x \rightarrow 0-0} 1 = 1$  va

$\lim_{x \rightarrow 0+0} f(x) = \lim_{x \rightarrow 0+0} \frac{1}{x} = +\infty$  tengliklarga egamiz. Bu yerdan ko'rinadiki,  $f(x)$  funksiya  $x = 0$  nuqtada cheksiz katta funksiya ham emas, shuningdek chekli limitga ham ega emas.

Agar  $\lim_{x \rightarrow a} f(x) = 0$  bo'lsa,  $f(x)$  funksiya  $x = a$  nuqtada *cheksiz kichik funksiya* deyiladi. Masalan,  $y = \sqrt{x-4}$ ,  $y = \sqrt{x}-2$  funksiyalarning har biri  $x = 4$  nuqtada cheksiz kichikdir.

Cheksiz kichik va cheksiz katta funksiyalar orasidagi munosabatni ifodalovchi teoremani isbotsiz keltiramiz.

**Teorema.** Agar  $f(x)$  funksiya  $x = a$  nuqtada cheksiz katta (cheksiz kichik)

funksiya bo'lsa,  $\frac{1}{f(x)}$  funksiya  $x = a$  nuqtada cheksiz kichik (cheksiz katta) funksiya bo'ladi.

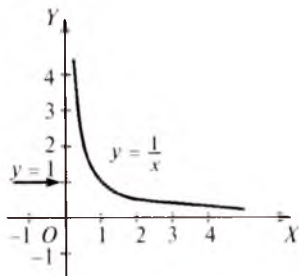

IV.11-rasm.



1 - e s l a t m a . Funksiyaning  $x \rightarrow a$  dagi (yoki  $x \rightarrow a - 0$ , yoki  $x \rightarrow a + 0$  dagi) limitining ta'rifida  $x \neq a$  qiymatlar qaraldi,  $a$  nuqtaning o'zida funksiya aniqlanmagan bo'lishi ham mumkin.

2 - e s l a t m a . Funksiyaning  $x \rightarrow a$  dagi (yoki  $x \rightarrow a - 0$  dagi, yoki  $x \rightarrow a + 0$  dagi) limitining ta'rifida ta'kidlanayotgan  $M$  va  $N$  sonlar  $\varepsilon$  va  $a$  ga bog'liqdir.



## Mashqlar

**4.4. Tenglikni isbotlang:**

$$1) \lim_{x \rightarrow 0} (3x + 5) = 5; \quad 2) \lim_{x \rightarrow 8} \sqrt[3]{x} = 2; \quad 3) \lim_{x \rightarrow \frac{1}{2}} \frac{x^2 - 0,25}{x - 0,5} = 1;$$

$$4) \lim_{x \rightarrow 4} \frac{x-4}{\sqrt{x}-2} = 4; \quad 5) \lim_{x \rightarrow 2} \frac{x-2}{x^2 - 5x + 6} = \frac{1}{5}; \quad 6) \lim_{x \rightarrow 1} \frac{1}{x} = 1.$$

**4.5. Limitlarni hisoblang:**

$$1) \lim_{x \rightarrow 2} (4x - 5); \quad 2) \lim_{x \rightarrow 3} \sqrt{x^2 + 7}; \quad 3) \lim_{x \rightarrow 8} \sqrt{x^2 + 36};$$

$$4) \lim_{x \rightarrow 9} (x^3 - 5); \quad 5) \lim_{x \rightarrow 3} \frac{x^2 - 9}{x - 3}; \quad 6) \lim_{x \rightarrow 0} \frac{1}{2x + 1}.$$

### 3. Funksiyaning nuqtadagi limiti haqidagi asosiy teoremlar.

Oldingi bandlarda funksiyaning nuqtadagi limiti tushunchasini qaradik. Bu bandeda funksiyaning nuqtadagi limiti haqidagi asosiy teoremlarni keltiramiz va limitni hisoblash masalasi bilan shug'ullanamiz.

1 - t e o r e m a .  $f(x)$  funksiya  $x \rightarrow a$  da ko'pi bilan bitta limitga ega bo'lishi mumkin.

2 - t e o r e m a . Agar  $\lim_{x \rightarrow a} f(x) = b$  ( $b \in \mathbb{R}$ ) bo'lsa,  $x = a$  nuqtaning biror atrofida  $f(x)$  funksiya chegaralangan bo'ladi.

3 - t e o r e m a . Agar  $\lim_{x \rightarrow a} f(x) = b$  bo'lib,  $b \neq 0$  bo'lsa,  $x = a$  nuqtaning shunday bir atrofi topiladiki, bu atrofda barcha  $x$  lar uchun ( $x = a$  bundan mustasno bo'lishi mumkin)  $f(x)$  ning ishorasi  $b$  ning ishorasi bilan bir xil bo'ladi.

4-teorema. Agar  $\lim_{x \rightarrow a} f(x) = b$  bo'lib,  $x = a$  nuqtaning biror atrofidagi barcha  $x \neq a$  lar uchun  $f(x) \geq 0$  ( $f(x) \leq 0$ ) bo'lsa,  $b \geq 0$  (mos ravishda,  $b \leq 0$ ) bo'ladi.

5-teorema. Agar  $x = a$  nuqtaning biror atrofidagi barcha  $x \neq a$  larda  $\varphi(x) \leq f(x) \leq g(x)$  bo'lib,  $\lim_{x \rightarrow a} \varphi(x) = \lim_{x \rightarrow a} g(x) = b$  bo'lsa,  $\lim_{x \rightarrow a} f(x) = b$  bo'ladi.

6-teorema. O'zgarmasning limiti o'ziga teng:  $\lim_{x \rightarrow a} c = c$ .

7-teorema. O'zgarmas ko'paytuvchini limit belgisidan tashqariga chiqarish mumkin:  $\lim_{x \rightarrow a} (k \cdot f(x)) = k \cdot \lim_{x \rightarrow a} f(x)$ .

8-teorema. Agar  $f(x)$ ,  $g(x)$  funksiyalar  $x \rightarrow a$  da chekli limitga ega bo'lsa,  $f(x) \pm g(x)$ ,  $f(x) \cdot g(x)$  funksiyalar ham  $x \rightarrow a$  da chekli limitga ega va

$$\lim_{x \rightarrow a} (f(x) \pm g(x)) = \lim_{x \rightarrow a} f(x) \pm \lim_{x \rightarrow a} g(x),$$

$$\lim_{x \rightarrow a} (f(x) \cdot g(x)) = \lim_{x \rightarrow a} f(x) \cdot \lim_{x \rightarrow a} g(x)$$

tengliklar o'rinlidir.

9-teorema. Agar  $f(x)$ ,  $g(x)$  funksiyalar  $x \rightarrow a$  da chekli limitga ega va  $\lim_{x \rightarrow a} g(x) \neq 0$  bo'lsa,  $\lim_{x \rightarrow a} \frac{f(x)}{g(x)} = \frac{\lim_{x \rightarrow a} f(x)}{\lim_{x \rightarrow a} g(x)}$  tenglik o'rinli bo'ladi.

Bu teoremlarning isboti oliy matematika kursida qaraladi. Biz shu teoremlarning tatbiqi yordamida limitlarni hisoblaymiz.

1-misol.  $\lim_{x \rightarrow 3} (x^2 + 4x - 5)$  limitni hisoblaymiz.

Yechish. Yuqoridagi teoremlarga asosan

$$\begin{aligned} \lim_{x \rightarrow 3} (x^2 + 4x - 5) &= \lim_{x \rightarrow 3} x^2 + \lim_{x \rightarrow 3} (4x) - \lim_{x \rightarrow 3} 5 = \\ &= \lim_{x \rightarrow 3} x \cdot \lim_{x \rightarrow 3} x + 4 \lim_{x \rightarrow 3} x - 5 = 3 \cdot 3 + 4 \cdot 3 - 5 = 16. \end{aligned}$$

2-misol.  $\lim_{x \rightarrow 5} \frac{7x-5}{10+2x}$  limitni hisoblaymiz.

**Yechish.**  $\lim_{x \rightarrow 5} (10 + 2x) = 10 + 2 \cdot 5 = 20 \neq 0$  bo'lgani uchun 9-teoremani bevosita qo'llash mumkin:

$$\lim_{x \rightarrow 5} \frac{7x-5}{10+2x} = \frac{\lim_{x \rightarrow 5} (7x-5)}{\lim_{x \rightarrow 5} (10+2x)} = \frac{7 \cdot 5 - 5}{10 + 2 \cdot 5} = \frac{30}{20} = 1,5.$$

3 - misol.  $\lim_{x \rightarrow 2} \frac{x^2 - 4}{x - 2}$  limitni hisoblaymiz.

**Yechish.**  $\lim_{x \rightarrow 2} (x - 2) = 0$ ,  $\lim_{x \rightarrow 2} x^2 - 4 = 0$  bo'lgani uchun 9-teoremani bevosita qo'llash mumkin emas (bu holda  $\frac{0}{0}$  ko'rinishdagi aniqmaslikka ega bo'lamiz).  $x \rightarrow 2$  bo'lgani uchun  $x \neq 2$  deb hisoblash mumkin. Shu sababli:

$$\lim_{x \rightarrow 2} \frac{x^2 - 4}{x - 2} = \lim_{x \rightarrow 2} \frac{(x+2)(x-2)}{x-2} = \lim_{x \rightarrow 2} (x+2) = 4.$$

4 - misol.  $\lim_{x \rightarrow 2} \frac{x^3 + 3x^2 - 9x + 2}{x^3 - x - 6}$  limitni hisoblaymiz.

**Yechish.** Bevosita limitga o'tish natijasida  $\frac{0}{0}$  ko'rinishdagi aniqmaslik hosil bo'ladi.  $x \neq 2$  lar uchun

$$\frac{x^3 + 3x^2 - 9x + 2}{x^3 - x - 6} = \frac{(x-2)(x^2 + 5x + 1)}{(x-2)(x^2 + 2x + 3)} = \frac{x^2 + 5x + 1}{x^2 + 2x + 3}$$

tenglik o'rinli bo'lgani sababli

$$\lim_{x \rightarrow 2} \frac{x^3 + 3x^2 - 9x + 2}{x^3 - x - 6} = \lim_{x \rightarrow 2} \frac{x^2 + 5x + 1}{x^2 + 2x + 3} = \frac{2^2 + 5 \cdot 2 + 1}{2^2 + 2 \cdot 2 + 3} = 1 \frac{4}{11}.$$

5 - misol.  $\lim_{x \rightarrow 0} \frac{x}{\sqrt{1+x} - 1}$  limitni hisoblaymiz.

**Yechish.** Bevosita limitga o'tsak,  $\frac{0}{0}$  ko'rinishdagi aniqmaslikka ega bo'lamiz. Aniqmaslikni ochish uchun kasrning surat va maxrajini  $\sqrt{1+x} + 1 \neq 0$  ga (maxrajining qo'shmasiga) ko'paytirib olamiz:

$$\begin{aligned} \lim_{x \rightarrow 0} \frac{x}{\sqrt{1+x} - 1} &= \lim_{x \rightarrow 0} \frac{x(\sqrt{1+x} + 1)}{(\sqrt{1+x} - 1)(\sqrt{1+x} + 1)} = \lim_{x \rightarrow 0} \frac{x(\sqrt{1+x} + 1)}{x} = \\ &= \lim_{x \rightarrow 0} (\sqrt{1+x} + 1) = 2. \end{aligned}$$

6-misol.  $\lim_{x \rightarrow 1} \frac{2x-2}{\sqrt[3]{26+x}-3}$  limitni hisoblaymiz.

Yechish. Bu yerda ham  $\frac{0}{0}$  ko'rinishdagi aniqmaslikni ochish kerak.  $26+x = t^3$  deb olamiz (o'rniga qo'yish usuli).  $x \rightarrow 1$  da  $t = \sqrt[3]{26+x} \rightarrow 3$  bo'lgani uchun

$$\lim_{x \rightarrow 1} \frac{2x-2}{\sqrt[3]{26+x}-3} = \lim_{t \rightarrow 3} \frac{2(t^3-26)-2}{t-3} = \lim_{t \rightarrow 3} \frac{2(t-3)(t^2+3t+9)}{t-3} = 54.$$

10-teorema. Agar  $\lim_{x \rightarrow a} g(x) = 0$  va  $\lim_{x \rightarrow a} f(x) = b \neq 0$  ( $b \in \mathbb{R}$ ) bo'lib,  $x = a$  nuqtaning biror atrofida ( $x = a$  nuqtaning o'zi bundan mustasno bo'lishi mumkin)  $g(x) \neq 0$  bo'lsa,  $\lim_{x \rightarrow a} \frac{f(x)}{g(x)} = \infty$  bo'ladi.

Isbot.  $\lim_{x \rightarrow a} \frac{g(x)}{f(x)} = \frac{\lim_{x \rightarrow a} g(x)}{\lim_{x \rightarrow a} f(x)} = \frac{0}{b} = 0$  bo'lgani uchun 2-band-

dagi teorema ko'ra,  $\lim_{x \rightarrow a} \frac{f(x)}{g(x)} = \infty$  bo'ladi.

7-misol.  $\lim_{x \rightarrow 2} \frac{3x+4}{\sqrt[3]{x-1}-1}$  limitni hisoblang.

Yechish.  $\lim_{x \rightarrow 2} (\sqrt[3]{x-1}-1) = 0$ ,  $\lim_{x \rightarrow 2} (3x+4) = 10$  bo'lgani

uchun 10-teorema ko'ra,  $\lim_{x \rightarrow 2} \frac{3x+4}{\sqrt[3]{x-1}-1} = \infty$  bo'ladi. Hisoblashni quyidagicha rasmiylashtirish mumkin:

$$\lim_{x \rightarrow 2} \frac{3x+4}{\sqrt[3]{x-1}-1} = \frac{3 \cdot 2 + 4}{\sqrt[3]{2-1}-1} = \frac{10}{0} = \infty.$$



## Mashqlar

4.6. Limitlarni hisoblang:

- 1)  $\lim_{x \rightarrow 2} (4x^2 - 3x + 5)$ ;      2)  $\lim_{x \rightarrow 2} \frac{2x+3}{x-4}$ ;      3)  $\lim_{x \rightarrow 2} \frac{x^2-4}{x-2}$ ;

$$4) \lim_{x \rightarrow 2} \frac{x^2 - 5x + 6}{x^2 - 4}; \quad 5) \lim_{x \rightarrow 3} \frac{\sqrt{x+1} - 2}{x-3}; \quad 6) \lim_{x \rightarrow 3} \frac{\sqrt{x+3} - \sqrt{2x-3}}{\sqrt[3]{x+3} - 2}.$$

#### 4.7. Tengliklar to'g'rimi:

$$1) \lim_{x \rightarrow 2} \frac{x^2 - 4}{x^3 - 14} = 0; \quad 2) \lim_{x \rightarrow -2} \frac{x^4 + 5x^3 + 6x^2}{x^2 - 3x - 10} = -\frac{4}{7};$$

$$3) \lim_{x \rightarrow 0} \frac{(1+x)(1+2x)(1+3x)}{x} = -5; \quad 4) \lim_{x \rightarrow 1} \frac{\sqrt{x} - 1}{x^2 - 1} = \frac{1}{4};$$

$$5) \lim_{x \rightarrow 2} \frac{x - \sqrt{3x-2}}{x^2 - 4} = \frac{1}{8}; \quad 6) \lim_{x \rightarrow 4} \frac{\sqrt{1+2x}}{\sqrt{x-2}} = \frac{4}{3};$$

$$7) \lim_{x \rightarrow -8} \frac{\sqrt{1-x} - 3}{2 + \sqrt[3]{x}} = -2; \quad 8) \lim_{x \rightarrow 9} \frac{\sqrt[3]{x-1} - 2}{x-9} = \frac{1}{12};$$

$$9) \lim_{x \rightarrow 16} \frac{\sqrt[4]{x} - 2}{\sqrt{x} - 4} = \frac{1}{9}; \quad 10) \lim_{x \rightarrow 0} \frac{\sqrt{1+x} - \sqrt{1-x}}{\sqrt[3]{1+x} - \sqrt[3]{1-x}} = \frac{9}{2};$$

$$11) \lim_{x \rightarrow 1} \left[ \left( \frac{4}{x^2 - x^{-1}} - \frac{1 - 3x + x^2}{1 - x^3} \right)^{-1} + 3 \cdot \frac{x^4 - 1}{x^3 - x^{-1}} \right] = 3;$$

$$12) \lim_{x \rightarrow 2} \left[ \left( \frac{x^3 - 4x}{x^3 - 8} \right)^{-1} - \left( \frac{x + \sqrt{2x}}{x-2} - \frac{\sqrt{2}}{\sqrt{x} - \sqrt{2}} \right)^{-1} \right] = \frac{1}{2}.$$

**4. Funksiyaning cheksizlikdagi limiti.** Biz natural argumentli funksiya (sonli ketma-ketlik)ning limiti tushunchasi bilan tanishmiz. Bu limitni natural argumentli funksiyaning  $+\infty$  dagi limiti sifatida talqin etish mumkin.

Bu bandda uzluksiz argumentli  $y = f(x)$  funksiyaning  $+\infty$  dagi,  $-\infty$  dagi va  $\infty$  dagi limiti tushunchasi bilan tanishamiz.

Dastlab, funksiyaning cheksizlikdagi chekli limiti tushunchasini qaraylik.

$(T; +\infty)$  oraliqda aniqlangan (bu yerda  $T$  – biror haqiqiy son)  $y = f(x)$  funksiya va  $A \in \mathbb{R}$  son berilgan bo'lsin. Agar  $\forall \varepsilon > 0$  son uchun, shunday  $M \in (T; +\infty)$  son mavjud bo'lib,  $\forall x \in (M; +\infty)$  sonlar uchun  $|f(x) - A| < \varepsilon$  tengsizlik bajarilsa,  $A$  son  $f(x)$  funksiyaning  $+\infty$  dagi limiti deyiladi va

$$\lim_{x \rightarrow +\infty} f(x) = A \quad (1)$$

ko'rinishda belgilanadi.

$|f(x) - A| < \varepsilon$  tengsizlik  $A - \varepsilon < f(x) < A + \varepsilon$  tengsizlikka teng kuchli bo'lgani uchun (1) tenglikning o'rinli bo'lishi geometrik jihatdan quyidagini anglatadi:

agar  $\lim_{x \rightarrow +\infty} f(x) = A$  bo'lsa,  $\forall \varepsilon > 0$  son uchun shunday  $M$  son topiladiki,  $y = f(x)$  funksiyaning  $(M; +\infty)$  oraliqdagi grafigi  $y = A - \varepsilon$  va  $y = A + \varepsilon$  to'g'ri chiziqlar bilan chegaralangan yo'lakda yotadi (IV.12-rasm).

1 - misol.  $\lim_{x \rightarrow +\infty} \frac{1}{x} = 0$  tenglikni isbotlaymiz.

Isbot.  $y = \frac{1}{x}$  funksiya  $(0; +\infty)$  oraliqda aniqlangan funksiyadir.

Uning  $+\infty$  dagi limiti 0 ga tengligini isbotlaymiz.  $\varepsilon$  ixtiyoriy musbat son bo'lsin.  $|f(x) - A| < \varepsilon$  tengsizlikni tuzamiz:  $|\frac{1}{x} - 0| < \varepsilon$  yoki  $|\frac{1}{x}| < \varepsilon$ .  $x > 0$  ekanligini e'tiborga olib, oxirgi tengsizlikdan  $x > \frac{1}{\varepsilon}$  ni hosil qilamiz. Bundan, ta'rifdagi  $M$  son sifatida  $\frac{1}{\varepsilon}$  dan katta bo'lgan har qanday son olish mumkinligi ko'rinadi. Demak,  $\lim_{x \rightarrow +\infty} \frac{1}{x} = 0$  tenglik o'rinlidir.

Endi  $y = f(x)$  funksiya berilgan bo'lib,  $y = f(-x)$  funksiyaning  $x \rightarrow +\infty$  dagi limiti haqida gapirish mumkin bo'lsin.

Agar  $\lim_{x \rightarrow +\infty} f(-x) = A$  bo'lsa (bu yerda  $A \in R$ ),  $A$  son  $f(x)$

funksiyaning  $x \rightarrow -\infty$  dagi limiti deyiladi va  $\lim_{x \rightarrow -\infty} f(x) = A$  ko'rinishda belgilanadi.

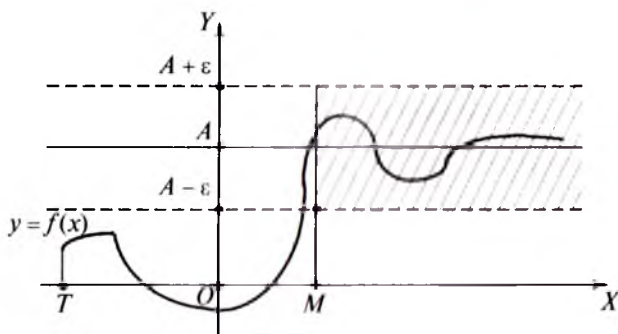

IV.12-rasm.

2 - misol.  $\lim_{x \rightarrow -\infty} \left(-\frac{1}{x}\right) = 0$  tenglikni isbotlaymiz.

Isbot.  $f(x) = -\frac{1}{x}$ ,  $f(-x) = \frac{1}{x}$  funksiyalarni qaraymiz.  $f(-x)$  funksiyaning  $x \rightarrow +\infty$  dagi limiti mavjud va 0 soniga teng (1-misol) bo'lgani uchun  $\lim_{x \rightarrow -\infty} f(x) = 0$  tenglik o'rinlidir.

Agar  $\lim_{x \rightarrow -\infty} f(x) = A$  va  $\lim_{x \rightarrow +\infty} f(x) = A$  tengliklar bir vaqtda o'rinli bo'lsa (bu yerda  $A \in R$ ),  $A$  son  $y = f(x)$  funksiyaning  $x \rightarrow \infty$  dagi limiti deyiladi va  $\lim_{x \rightarrow x} f(x) = A$  ko'rinishda belgilanadi.

3 - misol.  $\lim_{x \rightarrow \infty} \frac{1}{x} = 0$  ekanligini isbotlaymiz.

Isbot.  $\lim_{x \rightarrow +\infty} \frac{1}{x} = 0$ ,  $\lim_{x \rightarrow -\infty} \frac{1}{x} = 0$  bo'lgani uchun (1- va 2-misollar),  $\lim_{x \rightarrow \infty} \frac{1}{x} = 0$  tenglik o'rinlidir.

$\lim_{x \rightarrow +\infty} \frac{1}{x} = 0$  ( $\lim_{x \rightarrow -\infty} \frac{1}{x} = 0$ ) ekanligi, geometrik jihatdan,  $x$  ning yetarlicha katta musbat qiymatlarida (yetarlicha kichik manfiy qiymatlarida)  $y = \frac{1}{x}$  funksiyaning grafigi  $y = 0$  to'g'ri chiziqqa yetarlicha yaqinlashib kelishini,  $\lim_{x \rightarrow \infty} \frac{1}{x} = 0$  ekanligi esa  $x$  ning moduli yetarlicha katta bo'lgan qiymatlarida  $y = \frac{1}{x}$  funksiyaning grafigi  $y = 0$  to'g'ri chiziqqa yetarlicha yaqin bo'lishini bildiradi (IV.13-rasm).

Agar  $\lim_{x \rightarrow +\infty} f(x) = 0$  bo'lsa,  $f(x)$  funksiya  $x \rightarrow +\infty$  da cheksiz kichik funksiya deyiladi.

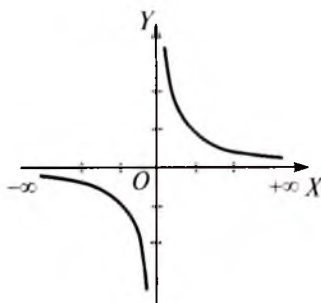

IV.13-rasm.

1-misolda  $y = \frac{1}{x}$  funksiyaning  $x \rightarrow +\infty$  da cheksiz kichik ekanligi isbotlandi.

Funksiyaning  $x \rightarrow +\infty$  da, shuningdek,  $x \rightarrow -\infty$  da cheksiz kichik funksiya bo'lishligi yuqoridagiga o'xshash ta'riflanadi.

Funksiyaning nuqtadagi limitining xossalari bu bandeda qaralgan limitlar uchun ham o'z kuchini saqlaydi.

4 - misol.  $\lim_{x \rightarrow +\infty} \frac{6x^2 + x - 1}{x^2 - 0,9}$  limitni hisoblaymiz.

Yechish. Bu limitni sonli ketma-ketlikning limitini hisoblashda tutilgan yo'ldan foydalanib hisoblaymiz:

$$\lim_{x \rightarrow +\infty} \frac{6x^2 + x - 1}{x^2 - 0,9} = \lim_{x \rightarrow +\infty} \frac{6 + \frac{1}{x} - \frac{1}{x^2}}{1 - \frac{0,9}{x^2}} = \frac{6 + 0 - 0}{1 - 0} = 6.$$

Endi funksiyaning cheksizlikdagi cheksiz limiti tushunchasini qaraymiz.

$f(x)$  funksiya biror  $(T; +\infty)$  oraliqda (bu yerda  $T \in \mathbb{R}$ ) aniqlangan funksiya va  $\lim_{x \rightarrow +\infty} \frac{1}{f(x)} = 0$  bo'lsin. U holda,  $f(x)$  funksiyaning  $x \rightarrow +\infty$  dagi limiti  $\infty$  ga teng deyiladi va  $\lim_{x \rightarrow +\infty} f(x) = \infty$  ko'rinishda belgilanadi.

5 - misol.  $\lim_{x \rightarrow +\infty} (x^2 + 5) = \infty$  ekanligini isbotlaymiz.

Isbot.  $\lim_{x \rightarrow +\infty} \frac{1}{x^2 + 5} = \lim_{x \rightarrow +\infty} \frac{1}{1 + \frac{5}{x^2}} = \frac{0}{1 + 0} = 0$  bo'lgani uchun yuqori

ridagi ta'rifga ko'ra  $\lim_{x \rightarrow +\infty} (x^2 + 5) = \infty$  bo'ladi.

Agar  $\lim_{x \rightarrow +\infty} f(x) = \infty$  bo'lib,  $f(x)$  funksiya biror  $(M; +\infty)$  oraliqdagi barcha  $x$  larda faqat musbat (faqat manfiy) qiymatlar qabul qilsa,  $\lim_{x \rightarrow +\infty} f(x) = +\infty$  (mos ravishda  $\lim_{x \rightarrow +\infty} f(x) = -\infty$ ) deyiladi.

6 - misol.  $\lim_{x \rightarrow +\infty} (5 - x^2) = -\infty$  ekanligini isbotlaymiz.

Isbot.  $\lim_{x \rightarrow +\infty} (5 - x^2) = \infty$  ekanligi 5-misoldagidek ko'rsatiladi.

$(3; +\infty)$  oraliqdagi barcha  $x$  sonlar uchun,  $5 - x^2 < 0$  ekanligini ko'rish qiyin emas. Demak,  $\lim_{x \rightarrow +\infty} (5 - x^2) = -\infty$ .

Agar  $\lim_{x \rightarrow +\infty} f(x) = \infty$  tenglik bajarilsa,  $f(x)$  funksiya  $x \rightarrow +\infty$  da cheksiz katta funksiya deyiladi. Masalan,  $y = x^2 + 5$  va  $y = 5 - x^2$



funksiyalarning har biri  $x \rightarrow +\infty$  da cheksiz katta funksiyalardir (5- va 6-misollar).

$x \rightarrow -\infty$  va  $x \rightarrow \infty$  dagi cheksiz limit va cheksiz katta funksiya tushunchalari yuqoridagiga o'xshash aniqlanadi.



## Mashqlar

### 4.8. Limitlarni hisoblang:

$$1) \lim_{x \rightarrow \infty} \frac{(2x-3)(3x+5)(4x-6)}{3x^2+x-1}; \quad 2) \lim_{x \rightarrow \infty} \frac{x}{\sqrt[3]{x^3+10}};$$

$$3) \lim_{x \rightarrow \infty} \frac{(x+1)^2}{x^2+1}; \quad 4) \lim_{x \rightarrow \infty} \frac{x^2-5x+1}{3x+7};$$

$$5) \lim_{x \rightarrow \infty} \frac{1000x}{x^2-1}; \quad 6) \lim_{x \rightarrow \infty} \frac{2x^2-x+3}{x^3-8x+5};$$

$$7) \lim_{x \rightarrow \infty} \frac{(2x+3)^3(3x-2)^2}{x^5+5}; \quad 8) \lim_{x \rightarrow \infty} \frac{x^2}{10+x\sqrt{x}};$$

$$9) \lim_{x \rightarrow \infty} \frac{2x^2-3x-4}{\sqrt{x^4+1}}; \quad 10) \lim_{x \rightarrow \infty} \frac{\sqrt[3]{x^2+1}}{x+1};$$

$$11) \lim_{x \rightarrow \infty} \frac{2x+3}{x+\sqrt[3]{x}}; \quad 12) \lim_{x \rightarrow \infty} \frac{\sqrt{x}}{\sqrt{x+\sqrt{x+\sqrt{x}}}}.$$

**5. Funksiya grafiting asimptotasi.**  $y=f(x)$  funksiya va uning grafigi  $\Gamma$  berilgan bo'lsin. Agar  $\Gamma$  chiziqning shunday bir  $M(x_0; f(x_0))$  nuqtasi va shunday bir  $l$  to'g'ri chiziq mavjud bo'lib,  $M$  nuqtadan boshlab hisoblanganda,  $\Gamma$  chiziqning va  $l$  to'g'ri chiziqning mos nuqtalari orasidagi masofa  $x \rightarrow a$  ( $x \rightarrow a+0$ ,  $x \rightarrow a-0$ ,  $x \rightarrow +\infty$ ,  $x \rightarrow -\infty$ ) da cheksiz kichraysa,  $l$  to'g'ri chiziq  $\Gamma$  grafikning asimptotasi deyiladi.

Funksiya grafiting vertikal, gorizontal va og'ma asimptotalari mavjud bo'lishi mumkin. Ularni alohida-alohida qarab chiqamiz.

Agar  $\lim_{x \rightarrow a+0} f(x)$  yoki  $\lim_{x \rightarrow a-0} f(x)$  limitlarning aqalli birortasi  $+\infty$  yoki  $-\infty$  ga teng bo'lsa,  $x=a$  to'g'ri chiziq  $f$  funksiya grafiting vertikal asimptotasi deyiladi.

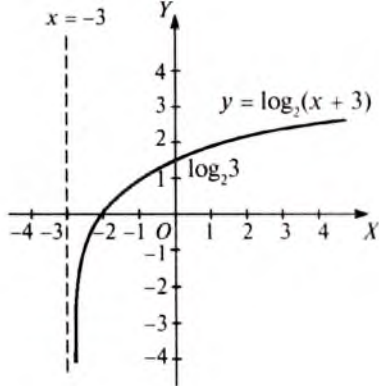

IV.14-rasm.

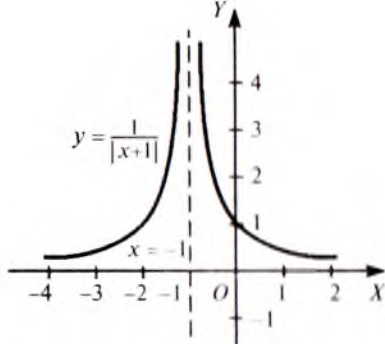

IV.15-rasm.

1 - misol.  $y = \log_2(x + 3)$  funksiya  $x = -3$  vertikal asimptotaga ega, chunki  $\lim_{x \rightarrow -3+0} \log_2(x + 3) = -\infty$  (IV.14-rasm).

2 - misol.  $x = -1$  to'g'ri chiziq  $y = \frac{1}{|x+1|}$  funksiya grafigining vertikal asimptotasi, chunki  $\lim_{x \rightarrow -1} \frac{1}{|x+1|} = +\infty$  (IV. 15-rasm).

Agar  $\lim_{x \rightarrow -\infty} f(x) = b$ ,  $\lim_{x \rightarrow +\infty} f(x) = b$  shartlarning aqalli birortasi bajarilsa,  $y = b$  to'g'ri chiziq  $y = f(x)$  funksiya grafigining gorizontal asimptotasi deyiladi.

3 - misol.  $\lim_{x \rightarrow +\infty} \frac{1}{|x+1|} = 0$  bo'lgani uchun  $y = 0$  to'g'ri chiziq  $y = \frac{1}{|x+1|}$  funksiya grafigining  $x \rightarrow +\infty$  dagi gorizontal asimptotasi bo'ladi. Bu to'g'ri chiziq shu funksiya grafigining  $x \rightarrow -\infty$  dagi gorizontal asimptotasi hamdir (IV. 15-rasm).

4 - misol.  $\lim_{x \rightarrow -\infty} (2 + 3^x) = 2$  bo'lgani uchun  $y = 2$  to'g'ri chiziq  $y = 2 + 3^x$  funksiya grafigining gorizontal asimptotasi (IV.16-rasm).

Agar  $\lim_{x \rightarrow +\infty} [f(x) - (kx + b)] = 0$ ,  $\lim_{x \rightarrow -\infty} [f(x) - (kx + b)] = 0$  tengliklarning aqalli birortasi bajarilsa,  $y = kx + b$  to'g'ri chiziq  $f(x)$  funksiya grafigining og'ma asimptotasi deyiladi, bunda  $k \neq 0$ .

5 - misol.  $y = x + \frac{1}{x} - 1$  funksiya  $y = x - 1$  og'ma asimptotaga ega (IV.17-rasm).

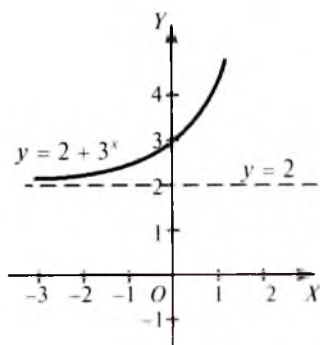

IV.16-rasm.

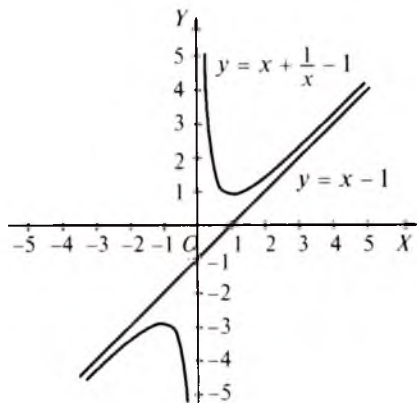

IV.17-rasm.

Agar  $\lim_{x \rightarrow +\infty} \frac{f(x)}{x} = k$ , ( $k \neq 0$ ) va  $\lim_{x \rightarrow +\infty} (f(x) - kx) = b$  chekli limitlar mavjud bo'lsa,  $y = kx + b$  to'g'ri chiziq  $f(x)$  funksiya grafigining  $x \rightarrow +\infty$  dagi og'ma asimptotasi bo'lishligi, shuningdek,

$\lim_{x \rightarrow -\infty} \frac{f(x)}{x} = k$  va  $\lim_{x \rightarrow -\infty} (f(x) - kx) = b$  chekli limitlar mavjud

bo'lsa,  $y = kx + b$  to'g'ri chiziq  $f(x)$  funksiya grafigining  $x \rightarrow -\infty$  dagi og'ma asimptotasi bo'lishligi oliy matematika kursida isbotlanadi.

Biz funksiyaning og'ma asimptotasini izlashda shu tasdiqlardan foydalanamiz.

6 - misol.  $f(x) = \frac{x^4 - 1}{x^3 + 6}$  funksiya grafigining og'ma asimptotasini topamiz.

Yechish.

$$k = \lim_{x \rightarrow +\infty} \frac{f(x)}{x} = \lim_{x \rightarrow +\infty} \frac{x^4 - 1}{x(x^3 + 6)} = 1, \quad b = \lim_{x \rightarrow +\infty} (f(x) - 1 \cdot x) =$$

$$= \lim_{x \rightarrow +\infty} \left( \frac{x^4 - 1}{x^3 + 6} - x \right) = 0 \quad \text{bo'lgani uchun } y = x \text{ to'g'ri chiziq } f(x)$$

funksiya grafigining  $x \rightarrow +\infty$  dagi og'ma asimptotasi bo'ladi.  $y = x$  to'g'ri chiziq shu funksiya grafigining  $x \rightarrow -\infty$  dagi og'ma asimptotasi bo'lishligini ham ko'rsatish mumkin.

Kasr-ratsional funksiya grafigining asimptotasini topishning yana bir usulini keltiramiz.

$f(x) = \frac{x^4-1}{x^3+6}$  funksiya berilgan bo'lsin. Suratdagi ko'phadni maxrajdagi ko'phadga bo'lib,  $\frac{x^4-1}{x^3+6} = x - \frac{6x+1}{x^3+6}$  ekanligini ko'ramiz.  $x \rightarrow \pm\infty$  da  $\frac{6x+1}{x^3+6} \rightarrow 0$  bo'lgani uchun  $\frac{x^4-1}{x^3+6} - x \rightarrow 0$  bo'ladi. Bu esa  $y = x$  to'g'ri chiziq  $y = \frac{x^4+1}{x^3+6}$  funksiyaning asimptotasi bo'lishini bildiradi (6-misol bilan solishtiring).



## Mashqlar

**4.9.**  $f(x) = \frac{x^4-1}{x^4+1}$  funksiya grafigining gorizontal asimptotalarini toping.

**4.10.**  $f(x) = \frac{x^4-1}{x^3+6}$  funksiya grafigining vertikal asimptotalarini toping.

**4.11.**  $f(x) = x \cdot \cos \frac{\pi}{x}$  funksiya grafigining og'ma asimptotalarini toping.

**4.12.** Funksiya grafigining asimptotalarini toping:

1)  $y = \frac{1}{(x-2)^2}$ ;

2)  $y = \frac{x^2}{x^2+9}$ ;

3)  $y = \sqrt{x^2-4}$ ;

4)  $y = \frac{x+1}{\sqrt{x^2+9}}$ ;

5)  $y = \frac{x^2+1}{\sqrt{x^2-1}}$ ;

6)  $y = \frac{\sin x}{x}$ ;

7)  $y = x \arctg x$ ;

8)  $y = x \left( 2 + \sin \frac{1}{x} \right)$ ;

9)  $y = \arcsin \frac{1}{x}$ ;

10)  $y = \arccos \frac{1}{x}$ .

## 2-§. Funksiyaning uzluksizligi

**1. Funksiyaning nuqtada uzluksizligi va uzilishi.** Funksiyaning nuqtadagi limiti tushunchasini o'rganganimizda, funksiya qaralayotgan nuqtada aniqlanmagan bo'lishi ham mumkinligi aytiladi.

Endi  $y = f(x)$  funksiya  $x = a$  nuqtaning faqat o'zidagina emas, balki uning biror atrofida ham aniqlangan bo'lsin.

Agar  $\lim_{x \rightarrow a} f(x) = f(a)$  tenglik bajarilsa,  $y = f(x)$  funksiya  $x = a$  nuqtada uzluksiz deyiladi.

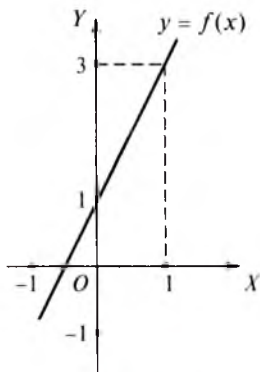

IV.18-rasm.

1 - misol.  $f(x) = 2x + 1$  funksiyani  $x = 1$  nuqtada uzluksizlikka tekshiramiz.

Yechish. Barcha haqiqiy sonlar to'plamida aniqlangan bu funksiyaning grafigi IV.18-rasmda tasvirlangan.

$$f(1) = 2 \cdot 1 + 1 = 3 \quad \text{va} \quad \lim_{x \rightarrow 1} f(x) = \\ = \lim_{x \rightarrow 1} (2x + 1) = 2 \cdot 1 + 1 = 3 \quad \text{bo'lgani uchun}$$

$\lim_{x \rightarrow 1} f(x) = f(1)$  tenglik o'rinlidir. Demak,

berilgan funksiya  $x = 1$  nuqtada uzluksizdir.

$$2 - \text{misol. } \varphi(x) = \begin{cases} \frac{x^2 - 1}{x - 1}, & \text{agar } x \neq 1 \text{ bo'lsa,} \\ 4, & \text{agar } x = 1 \text{ bo'lsa,} \end{cases} \quad \text{funksiyani } x = 1$$

nuqtada uzluksizlikka tekshiramiz.

Yechish.  $\varphi(1) = 4$  va  $\lim_{x \rightarrow 1} \frac{x^2 - 1}{x - 1} = \lim_{x \rightarrow 1} (x + 1) = 1 + 1 = 2$  munosabatlardan  $\lim_{x \rightarrow 1} \varphi(x) \neq \varphi(1)$  ekanligini ko'ramiz. Demak, berilgan  $\varphi(x)$  funksiya  $x = 1$  nuqtada uzluksiz emas (IV.19-rasm).

$x = a$  nuqtada uzluksiz bo'lgan funksiyalarning uzluksizlik ta'rifidan va funksiyaning nuqtadagi limitining mos xossalaridan kelib chiqadigan asosiy xossalarini keltiramiz:

1°. Agar  $y = f(x)$  va  $y = g(x)$  funksiyalar  $x = a$  nuqtada uzluksiz bo'lsa,  $f(x) \pm g(x)$ ,  $f(x) \cdot g(x)$  va  $\frac{f(x)}{g(x)}$  ( $g(a) \neq 0$ ) funksiyalar ham  $x = a$  nuqtada uzluksiz bo'ladi.

2°. Agar  $f(x)$  funksiya  $x = a$  nuqtada uzluksiz bo'lsa, u holda  $x = a$  nuqtaning shunday bir  $\delta$ -atrofi topiladiki,  $f(x)$  funksiya bu atrofda chegaralangan bo'ladi va agar  $f(a) \neq 0$  bo'lsa, bu atrofda  $f(x)$  ning ishorasi  $f(a)$  ishorasi bilan bir xil bo'ladi (IV.20-rasm).

Endi funksiyaning nuqtada chapdan va o'ngdan uzluksizligi tushunchalarini ta'riflaymiz.

Agar  $\lim_{x \rightarrow a-0} f(x) = f(a)$  ( $\lim_{x \rightarrow a+0} f(x) = f(a)$ ) tenglik bajarilsa,  $y = f(x)$  funksiya  $x = a$  nuqtada chapdan (o'ngdan) uzluksiz deyiladi.

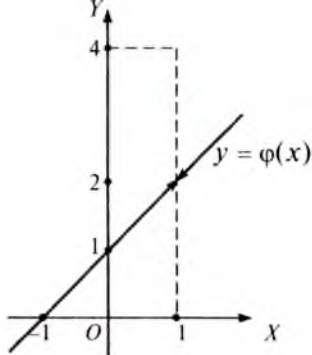

IV.19-rasm.

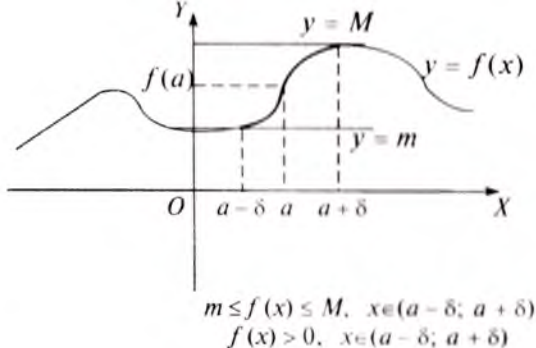

IV.20-rasm.

3 - misol.  $y = \begin{cases} x^2, & \text{agar } x \geq 0 \text{ bo'lsa,} \\ 3, & \text{agar } x < 0 \text{ bo'lsa} \end{cases}$  funksiyani va  $x = 0$

nuqtani qaraymiz. Bu funksiya  $x = 0$  nuqtada aniqlangan va bu nuqtada  $f(0) = 0^2 = 0$  ga teng qiymat qabul qiladi.

$$\lim_{x \rightarrow 0-0} f(x) = \lim_{x \rightarrow 0-0} 3 = 3 \quad \text{va} \quad \lim_{x \rightarrow 0+0} f(x) = \lim_{x \rightarrow 0+0} x^2 = 0^2 = 0$$

tengliklardan ko'rinadiki,  $\lim_{x \rightarrow 0-0} f(x) \neq f(0)$ ,  $\lim_{x \rightarrow 0+0} f(x) = f(0)$

munosabatlar bajariladi. Demak, qaralayotgan funksiya  $x = 0$  nuqtada o'ngdan uzluksiz, lekin chapdan uzluksiz emas (IV.21-rasm).

$x = a$  nuqtada chapdan ham, o'ngdan ham uzluksiz bo'lgan funksiya shu nuqtada uzluksiz bo'ladi va, aksincha,  $x = a$  nuqtada uzluksiz bo'lgan funksiya shu nuqtada chapdan ham, o'ngdan ham uzluksiz bo'ladi (isbotlang). Bu yerdan, 3-misoldagi  $y(x)$  funksiyaning  $x = 0$  nuqtada uzluksiz emasligi kelib chiqadi.

Agar  $\lim_{x \rightarrow a} f(x) = f(a)$  tenglik ma'noga ega bo'lmasa yoki bajarilmasa,  $f(x)$  funksiya  $x = a$  nuqtada uzilishga ega (uzluksiz emas) deyiladi va  $x = a$  nuqta funksiyaning uzilish nuqtasi deb ataladi.

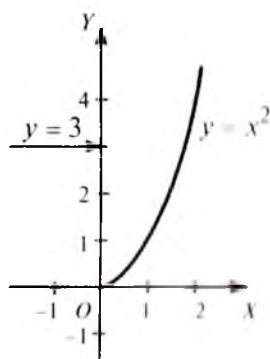

IV.21-rasm.

2-misoldagi  $\varphi(x)$  funksiya  $x = 1$  nuqtada, 3-misoldagi  $y(x)$  funksiya esa  $x = 0$  nuqtada uzilishga ega.

Agar  $f(x)$  funksiya o'zining uzilish nuqtasi  $x = a$  da chekli bir tomonli limitlarga ega bo'lsa,  $x = a$  nuqta  $f(x)$  funksiyaning *birinchi tur uzilish nuqtasi* deyiladi. Birinchi tur uzilish nuqtasi  $x = a$  dagi chekli bir tomonli limitlar teng, ya'ni  $\lim_{x \rightarrow a+0} f(x) = \lim_{x \rightarrow a-0} f(x)$  bo'lsa,  $x = a$  nuqta *tuzatib (yo 'qotib) bo'ladigan uzilish nuqtasi* deyiladi.

2-misoldagi  $\varphi(x)$  funksiya  $x = 1$  nuqtada tuzatib bo'ladigan uzilishga ega. Funksiyaning  $x = 1$  nuqtadagi qiymati sifatida 4 ni emas, balki  $\lim_{x \rightarrow 1} \varphi(x) = \lim_{x \rightarrow 1-0} \varphi(x) = \lim_{x \rightarrow 1+0} \varphi(x) = 2$  ni olsak,  $\varphi(x)$  funksiya  $x = 1$  nuqtada uzluksiz bo'lib qoladi (IV.19-rasm).

Agar  $x = a$  nuqtada  $f(x)$  funksiya birinchi tur uzilishga ega bo'lib,  $\lim_{x \rightarrow a-0} f(x) \neq \lim_{x \rightarrow a+0} f(x)$  munosabat bajarilsa,  $f(x)$  funksiya  $x = a$  nuqtada «sakrashga» ega deyiladi va  $\lim_{x \rightarrow a+0} f(x) - \lim_{x \rightarrow a-0} f(x)$  ayirma funksiyaning  $x = a$  nuqtadagi *sakrashi* deyiladi.

3-misoldagi  $y(x)$  funksiya  $x = 0$  nuqtada birinchi tur uzilishga ega va  $\lim_{x \rightarrow 0-0} y(x) = 3$ ,  $\lim_{x \rightarrow 0+0} y(x) = 0$  munosabatlar o'rinli.  $\lim_{x \rightarrow 0-0} y(x) \neq \lim_{x \rightarrow 0+0} y(x)$  bo'lgani uchun  $y(x)$  funksiya nuqtada  $x = 0$  nuqtada sakrashga ega va bu sakrash  $0 - 3 = -3$  ga teng (sakrash pastga qarab sodir bo'ldi!) (IV.21-rasm).

Agar  $y = f(x)$  funksiya  $x = a$  nuqtada uzilishga ega bo'lsa va  $x = a$  nuqta funksiyaning birinchi tur uzilish nuqtasi bo'lmasa,  $x = a$  nuqta funksiyaning *ikkinchi tur uzilish nuqtasi* deyiladi.

$$4\text{-misol. } f(x) = \begin{cases} 1, & \text{agar } x \leq 0 \text{ bo'lsa,} \\ \frac{1}{x}, & \text{agar } x > 0 \text{ bo'lsa} \end{cases} \quad \text{funksiya } x = 0$$

nuqtada ikkinchi tur tuzilishga ega, chunki  $\lim_{x \rightarrow 0-0} f(x) = 1$ ,

$\lim_{x \rightarrow 0+0} f(x) = +\infty$  (1-§, 2-band, 5-misol) bo'lgani uchun berilgan funksiya  $x = 0$  nuqtada uzilishga ega va bu uzilish birinchi tur uzilish emas (IV.11-rasm).



## Mashqlar

**4.13.** Funksiyani  $x = 0$  nuqtada uzluksizlikka tekshiring:

1)  $y = x^3$ ;

2)  $y = \begin{cases} 1 + x, & x > 0, \\ x^2, & x \leq 0; \end{cases}$

3)  $y = \begin{cases} -x^2 + 1, & x < 0, \\ x + 1, & x > 0, \\ 3, & x = 0; \end{cases}$

4)  $y = \begin{cases} -x, & x \geq 0, \\ x + 2, & x < 0; \end{cases}$

5)  $y = \begin{cases} \frac{1}{x}, & x \neq 0, \\ 2, & x = 0; \end{cases}$

6)  $y = \begin{cases} x^2 - 2x, & x > 0, \\ 3 - x, & x \leq 0. \end{cases}$

**4.14.**  $y = f(x)$  funksiyalar berilgan:

1)  $\frac{1}{4x+12}$ ;

2)  $\frac{1}{x^2-9}$ ;

3)  $\frac{x^2}{x^2-6x+9}$ ;

4)  $\frac{x+3}{x^2+2x-8}$ ;

5)  $\frac{x^2+2x-8}{x+3}$ .

Funksiyalarning uzilish nuqtalarini toping.

**4.15.** IV.22-rasmda tasvirlangan grafik bo'yicha, grafigi tasvirlangan funksiyaning  $(a; b)$  oraliqqa tegishli bo'lgan uzilish nuqtalarini toping.

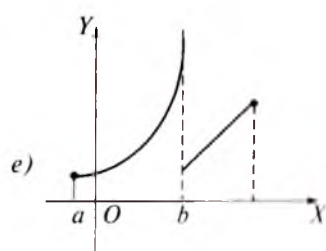
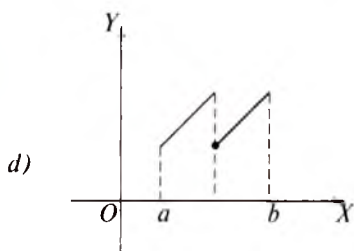
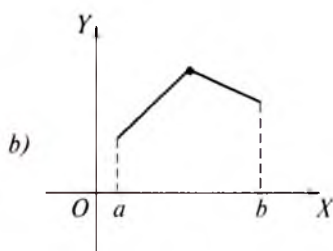
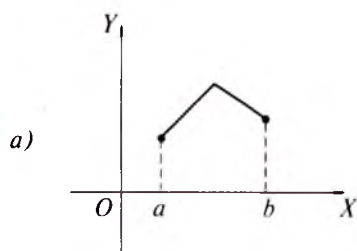

IV.22- rasm.



**4.16.** Funksiyaning uzilish nuqtalarini ko'rsating (isbotini keltirish shart emas):

$$1) y = \frac{1}{x}; \quad 2) y = \operatorname{tg}x; \quad 3) y = \frac{1}{x^2 - 1}; \quad 4) y = \frac{x-1}{x^2 - 1};$$

$$5) y = [x]; \quad 6) y = \operatorname{tg}x + \operatorname{ctg}x; \quad 7) y = \{x\}; \quad 8) y = \operatorname{tg}2x.$$

**4.17.** Butun son to'g'ri chizig'ida aniqlangan va

$$1) 0; 1 \text{ va } 2; \quad 2) -1; 0 \text{ va } 3;$$

$$3) \pi n, n \in \mathbb{Z}; \quad 4) \frac{\pi}{2} + 2\pi n, n \in \mathbb{Z}$$

nuqtalardan farqli bo'lgan barcha nuqtalarda uzluksiz bo'lgan funktsiya quring.

**4.18.** Funksiyaning uzilish nuqtalarini va uzilish turlarini aniqlang:

$$1) f(x) = \begin{cases} x^2 - 4, & \text{agar } x \leq 2 \text{ bo'lsa,} \\ 6 - 2x, & \text{agar } x > 2 \text{ bo'lsa;} \end{cases}$$

$$2) f(x) = \begin{cases} 9 - x^2, & \text{agar } x \leq 1 \text{ bo'lsa,} \\ 2x + 3, & \text{agar } x > 1 \text{ bo'lsa;} \end{cases}$$

$$3) f(x) = \begin{cases} x + 4, & \text{agar } x < -1 \text{ bo'lsa,} \\ x^2 + 2, & \text{agar } -1 \leq x < 1 \text{ bo'lsa,} \\ 2x, & \text{agar } x \geq 1 \text{ bo'lsa;} \end{cases}$$

$$4) f(x) = \frac{2x}{x-1}; \quad 5) f(x) = \frac{3x}{2x-3}.$$

**4.19.**  $y = f(x)$  funktsiya berilgan. Funksiyaning uzilish nuqtalaridagi bir tomonli limitlarni, sakrashlarni va  $[-4; 4]$  kesmadagi grafiginini yasang:

$$1) f(x) = \begin{cases} 4x + 5, & \text{agar } x \leq -1 \text{ bo'lsa,} \\ x^2 - 4x, & \text{agar } x > -1 \text{ bo'lsa;} \end{cases}$$

$$2) f(x) = \begin{cases} x^2 + 2, & \text{agar } x \leq 2 \text{ bo'lsa,} \\ x + 1, & \text{agar } x > 2 \text{ bo'lsa;} \end{cases}$$

$$3) f(x) = \begin{cases} -x, & \text{agar } x \leq 0 \text{ bo'lsa,} \\ -x(x-1)^2, & \text{agar } 0 < x < 2 \text{ bo'lsa,} \\ x - 3, & \text{agar } x \geq 2 \text{ bo'lsa;} \end{cases}$$

$$4) f(x) = \begin{cases} -2x, & \text{agar } x \leq 0 \text{ bo'lsa,} \\ \sqrt{x}, & \text{agar } 0 < x < 4 \text{ bo'lsa,} \\ 1, & \text{agar } x \geq 4 \text{ bo'lsa.} \end{cases}$$

**4.20.** Agar:

$$1) f(x) = (x^2 + 1)^5, x_0 = 0; \quad 2) f(x) = \frac{x^2 + 4x - 5}{x + 5}, x_0 = -5;$$

$$3) f(x) = \frac{3x-2}{9x-6}, x_0 = \frac{2}{3}; \quad 4) f(x) = \frac{x-1}{\sqrt{x-1}}, x_0 = 1$$

bo'lsa,  $A$  ning qanday qiymatida

$$F(x) = \begin{cases} f(x), & \text{agar } x \neq x_0 \text{ bo'lsa,} \\ A, & \text{agar } x = x_0 \text{ bo'lsa} \end{cases}$$

funksiya  $x = x_0$  nuqtada uzluksiz bo'ladi?

**2. Funksiyaning oraliqda uzluksizligi.** Agar  $y = f(x)$  funksiya  $X$  oraliqdagi barcha nuqtalarda uzluksiz bo'lsa,  $f(x)$  funksiya shu *oraliqda uzluksiz* deyiladi.

1 - misol.  $y = x^2 + x + 1$  funksiya  $X = (-\infty; +\infty)$  oraliqda uzluksizmi?

**Yechish.**  $(-\infty; +\infty)$  oraliqdagi barcha  $x = a$  nuqta uchun

$$\lim_{x \rightarrow a} y(x) = \lim_{x \rightarrow a} (x^2 + x + 1) = a^2 + a + 1 = f(a)$$

tenglik o'rinli bo'lgani sababli,  $y(x)$  funksiya  $X = (-\infty; +\infty)$  oraliqda uzluksizdir.

2 - misol.  $y = \frac{1}{x-3}$  funksiya  $x = (0; 5)$  oraliqda uzluksizmi?

**Yechish.** Berilgan funksiya  $x = 3 \in (0; 5)$  nuqtada aniqlanmagan. Shu sababli, u  $x = 3$  nuqtada uzilishga ega. Demak, berilgan funksiya  $x = (0; 5)$  oraliqda uzluksiz emas.

Kesmada uzluksiz bo'lgan funksiya bir qator ajoyib xossalarga ega. Shu sababli  $X = [a; b]$  bo'lgan holga alohida to'xtalamiz.

Agar  $y = f(x)$  funksiya barcha  $x \in (a; b)$  nuqtalarda uzluksiz bo'lsa va  $x = a$  nuqtada o'ngdan,  $x = b$  nuqtada esa chapdan uzluksiz bo'lsa,  $f(x)$  funksiya  $[a; b]$  kesmada uzluksiz deyiladi.

Endi kesmada uzluksiz bo'lgan funksiyaning xossalarini ifodalovchi teoremlarni va ularning geometrik talqinini keltiramiz.

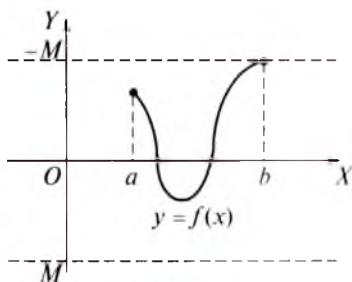

IV.23-rasm.

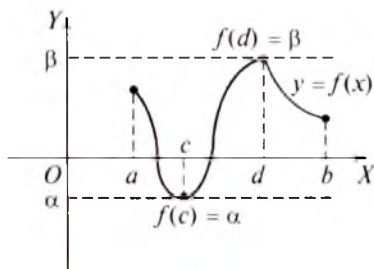

IV.24-rasm.

1 - teorema. Agar  $f(x)$  funksiya  $[a; b]$  kesmada uzluksiz bo'lsa, bu funksiya  $[a; b]$  oraliqda chegaralangan bo'ladi, ya'ni shunday o'zgarmas  $M > 0$  son topiladiki, barcha  $x \in [a; b]$  lar uchun

$$|f(x)| \leq M$$

tengsizlik bajariladi (IV.23-rasm).

$y = f(x)$  funksiyaning  $[a; b]$  kesmadagi grafigi  $[-M; M]$  yo'lakda joylashgan.

2 - teorema.  $[a; b]$  kesmada uzluksiz bo'lgan  $f(x)$  funksiya shu oraliqda o'zining eng katta va eng kichik qiymatlariga ega bo'ladi (IV.24-rasmga qarang:  $f(c) = \alpha$  — eng kichik qiymat,  $f(d) = \beta$  — eng katta qiymat).

3 - teorema.  $[a; b]$  kesmada uzluksiz  $f(x)$  funksiya uchun  $f(a) \cdot f(b) < 0$  bo'lsa, funksiya nolga teng qiymat qabul qiladigan, ya'ni  $f(c) = 0$  bo'ladigan kamida bitta  $c \in (a; b)$  nuqta mavjud bo'ladi (IV.25-rasm).

4 - teorema.  $f(x)$  funksiya  $[a; b]$  kesmada uzluksiz va  $\min\{f(a), f(b)\} = A$ ,  $\max\{f(a), f(b)\} = B$  bo'lsa,  $f(x)$  funksiya  $A$  va  $B$  orasidagi har qanday  $C$  qiymatni qabul qiladi (IV.26-rasm).

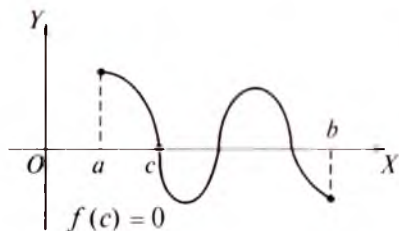

IV.25-rasm.

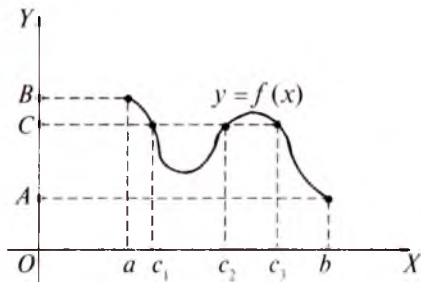

$$f(c_1) = C, f(c_2) = C, f(c_3) = C$$

IV.26-rasm.

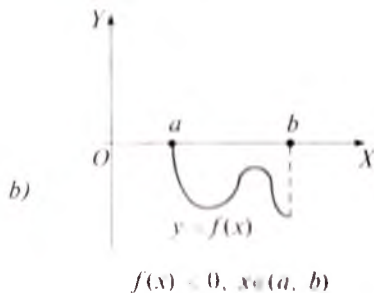
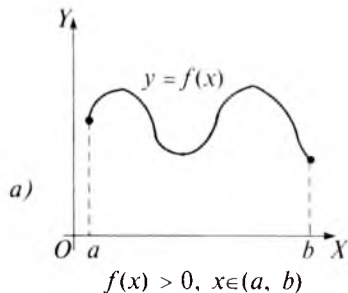

IV.27-rasm.

5 - t e o r e m a . Agar  $f(x)$  funksiya  $[a; b]$  kesmada uzluksiz va  $(a; b)$  intervalda nolga aylanmasa, u shu oraliqning barcha ichki nuqtalarida bir xil ishorali bo'ladi (IV.27-rasm).

$y = c$  ( $c = \text{const}$ ),  $y = x^n$ ,  $y = a^x$  ( $a > 0$ ,  $a \neq 0$ ),  $y = \log_a x$  ( $a > 0$ ,  $a \neq 0$ ),  $y = \sin x$ ,  $y = \cos x$ ,  $y = \operatorname{tg} x$ ,  $y = \operatorname{ctg} x$ ,  $y = \arcsin x$ ,  $y = \arccos x$ ,  $y = \operatorname{arctg} x$  va  $y = \operatorname{arctg} x$  funksiyalar eng sodda elementar funksiyalar, ular ustida chekli marta arifmetik amallar, shuningdek funksiyadan funksiya olish (funksiyalar superpozitsiyasi) amallarini bajarishdan hosil bo'lgan funksiyalar esa elementar funksiyalar deb atalishini eslatib o'tamiz.

Masalan,  $y = \sin(\ln^2 x + \cos x - x^2 + \operatorname{arctg}(\cos x^2) + 1)$  funksiya elementar funksiya, 1-bandda keltirilgan 2-misoldagi funksiya esa elementar funksiya emas.

Oliy matematika kursida quyidagi teorema isbotlanadi.

T e o r e m a . Barcha elementar funksiyalar o'zining aniqlanish sohasida uzluksizdir.

3 - m i s o l .  $y = \frac{1}{x^2 - 5x + 6}$  funksiya uzluksiz bo'ladigan barcha nuqtalar to'plamini topamiz.

Y e c h i s h . Berilgan funksiya elementar funksiya va uning aniqlanish sohasi  $(-\infty; 2) \cup (2; 3) \cup (3; +\infty)$  to'plamdan iborat. Yuqorida keltirilgan teoremaga ko'ra bu to'plam izlangan to'plamdir.

4 - m i s o l .  $y = (1+x)^{\frac{1}{x}}$  funksiya uzluksiz bo'ladigan barcha nuqtalar to'plamini toping.

Y e c h i s h . Bu funksiya darajali-ko'rsatkichli  $y = u(x)^{v(x)}$  funksiyaning xususiy holi bo'lib, darajali-ko'rsatkichli funksiya

ta'rifiga ko'ra  $y = (1+x)^{\frac{1}{x}} = e^{\ln(1+x)^{\frac{1}{x}}} = e^{\frac{1}{x} \ln(1+x)}$  tenglik o'rin-

lidir. Bundan qaralayotgan funksiya elementar funksiya ekanligi va uning aniqlanish sohasi  $(-1; 0) \cup (0; +\infty)$  to'plamdan iboratligini ko'ramiz.

Yuqorida keltirilgan teorema ko'ra,  $(-1; 0) \cup (0; +\infty)$  to'plam izlangan to'plamdir.



## Mashqlar

**4.21.** Funktsiyalarning uzluksizlik oraliqlarini toping:

$$1) y = \frac{x}{(x-1)(x-3)};$$

$$2) y = \frac{1}{x^2 + 2x - 3};$$

$$3) y = \frac{x^2 + 2x - 8}{x^3 - x^2 - 12x};$$

$$4) y = \frac{1}{x+3} - \frac{1}{x-4};$$

$$5) f(x) = \begin{cases} -x^2, & x < 0, \\ x-1, & x > 0; \end{cases};$$

$$6) f(x) = \begin{cases} \frac{1}{x}, & x \leq 2, x \neq 0, \\ 0, & x = 0, \\ x, & x > 2. \end{cases}$$

**4.22.**  $f(x)$  funksiyaning  $x = k, l, m, n$  dagi qiymatlarini hisoblang, ishoralarining saqlanish va nollari mavjud bo'lgan intervallarini aniqlang,  $[a; b]$  oraliqdagi nolini  $\varepsilon$  gacha aniqlikda toping («kesmani teng ikkiga bo'lish» va al-Koshiy usullarini tatbiq eting, mikrokalkulator yoki EHM dan foydalaning):

$$1) f(x) = x^3 - 6x + 5, k = -3, l = -2, m = 1,5, n = 2, a = l, b = m, \varepsilon = 0,001;$$

$$2) f(x) = x^3 - 4x - 3, k = -1,5, l = -1,2, m = 0, n = 4, a = -1,5, b = -1,2, \varepsilon = 0,001;$$

$$3) f(x) = x^3 - 3x + 2 = 0, k = -3, l = -1, m = 2, n = 3, a = -3, b = 0, \varepsilon = 0,01.$$

**4.23.**  $x^4 + x - \frac{2}{x} = 0$  tenglama  $[0,5; 1,5]$  kesmada ildizga ega ekanini isbot qiling va shu ildizni 0,01 gacha aniqlik bilan toping.

**4.24.** Tengsizlikni yeching:

$$1) (x + 5)(x - 4) > 0;$$

$$2) (x + 4)(x - 3) < 0;$$

$$3) (x + 2)(x + 4)(x + 5) \geq 0;$$

$$4) (x^2 - 1)(x + 6) < 0.$$

**4.25.** Tengsizlikni yeching:

1)  $(x - 1)^7(x + 2)(x + 4)^{10} > 0$ ;      2)  $x^3 - 4x^2 - x + 4 > 0$ .

**4.26.** Tengsizlikni yeching:

1)  $\frac{x^3+27}{(x^4-16)(x^2-25)} > 0$ ;      2)  $\frac{x^2-9}{x^3-2x^2+4x} \geq 0$ .

**3. Ajoyib limitlar.** Ko'pchilik hollarda limitlarni hisoblash masalasi

$$\lim_{x \rightarrow 0} \frac{\sin x}{x} = 1, \quad (1)$$

$$\lim_{x \rightarrow 0} (1 + x)^{\frac{1}{x}} = e \quad (2)$$

formular yordamida hal etilishi mumkin. Ulardan birini,

masalan, (1) tenglikni isbotlash bilan cheklanamiz.  $\frac{\sin(-x)}{-x} = \frac{\sin x}{x}$

tenglik barcha  $x \neq 0$  sonlari uchun o'rinli bo'lgani sababli, (1) tenglikni  $x \rightarrow 0 + 0$  bo'lgan hol uchun isbotlash yetarlidir.

$x \rightarrow 0 + 0$  bo'lsin. U holda  $x \in (0; \frac{\pi}{2})$  va  $\sin x > 0$  deb hisoblash mumkin.

Birlik aylananing  $2x$  radianli  $MN$  yoyini qaraymiz (IV.28-rasm). U holda  $MN = 2x$  va  $MN = 2 \sin x$ ,  $2MK = 2 \operatorname{tg} x$  tengliklar o'rinli bo'ladi, chunki  $M$  nuqtaning ordinatasi  $\sin x$  ga,  $MK$  uzunlik esa  $\operatorname{tg} x$  ga tengdir.

$MN < MN < 2MK$  yoki  $2 \sin x < 2x < 2 \operatorname{tg} x$ , ya'ni  $\sin x < x < \operatorname{tg} x$  ekanligini ko'ramiz. Bu tengsizlikning hamma hadlarini  $\sin x > 0$  ga bo'lib,  $1 < \frac{x}{\sin x} < \frac{1}{\cos x}$  va demak,

$$\cos x < \frac{\sin x}{x} < 1 \quad (3)$$

tengsizlikka ega bo'lamiz.

$y = \cos x$  funksiya uzluksiz bo'lgani uchun  $\lim_{x \rightarrow 0} \cos x = \cos 0 = 1$

tenglik o'rinli bo'ladi.

1-§, 3-band, 5-teoremaga ko'ra,

(3) tengsizlikdan  $\lim_{x \rightarrow 0} \frac{\sin x}{x} = 1$  ekanligi kelib chiqadi.

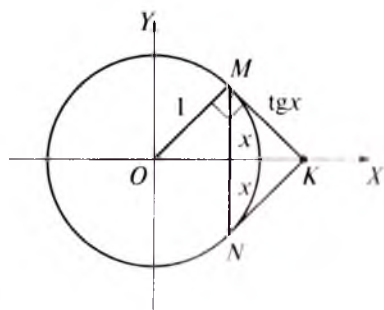

IV.28-rasm.

1 - misol.  $\lim_{x \rightarrow 0} \frac{\sin kx}{mx}$  limitni hisoblaymiz ( $k \neq 0, m \neq 0$ ).

Yechish.  $kx = t$  deb olamiz.  $x \rightarrow 0$  da  $t \rightarrow 0$  va, aksincha,  $t \rightarrow 0$  da  $x \rightarrow 0$  ekanini ko'rish qiyin emas. U holda (1) tenglikka ko'ra

$$\lim_{x \rightarrow 0} \frac{\sin kx}{mx} = \frac{1}{m} \lim_{x \rightarrow 0} \frac{k \sin kx}{kx} = \frac{k}{m} \lim_{x \rightarrow 0} \frac{\sin kx}{kx} = \frac{k}{m} \lim_{x \rightarrow 0} \frac{\sin t}{t} = \frac{k}{m} \cdot 1 = \frac{k}{m}$$

bo'ladi.

2 - misol.  $\lim_{x \rightarrow 0} \frac{\sin kx}{\sin mx}$  limitni hisoblaymiz ( $k \neq 0, m \neq 0$ ).

Yechish.  $\frac{\sin kx}{\sin mx} = \frac{m}{k} \cdot \frac{\sin kx}{mx} \cdot \frac{kx}{\sin mx} = \frac{m}{k} \cdot \frac{\sin kx}{mx} \cdot \frac{1}{\frac{\sin mx}{kx}}$  bo'lgani

uchun 1-misolga ko'ra

$$\begin{aligned} \lim_{x \rightarrow 0} \frac{\sin kx}{\sin mx} &= \lim_{x \rightarrow 0} \left( \frac{m}{k} \cdot \frac{\sin kx}{mx} \cdot \frac{1}{\frac{\sin mx}{kx}} \right) = \frac{m}{k} \cdot \lim_{x \rightarrow 0} \frac{\sin kx}{mx} \cdot \lim_{x \rightarrow 0} \frac{1}{\frac{\sin mx}{kx}} = \\ &= \frac{m}{k} \cdot \frac{k}{m} \cdot \frac{1}{\frac{1}{k}} = \frac{k}{m} \end{aligned}$$

bo'ladi.

3 - misol.  $\lim_{x \rightarrow 0} \frac{\cos 5x - \cos 9x}{x^2}$  limitni hisoblaymiz.

Yechish.  $\frac{\cos 5x - \cos 9x}{x^2} = \frac{2 \sin 7x \sin 2x}{x^2} = 2 \cdot \frac{\sin 7x}{x} \cdot \frac{\sin 2x}{x}$

bo'lgani uchun  $\lim_{x \rightarrow 0} \frac{\cos 5x - \cos 9x}{x^2} = 2 \cdot \lim_{x \rightarrow 0} \frac{\sin 7x}{x} \cdot \lim_{x \rightarrow 0} \frac{\sin 2x}{x} = 2 \cdot \frac{7}{1} \cdot \frac{2}{1} = 28$  tenglikka egamiz.

(1) tenglik *birinchi ajoyib limit*, (2) tenglik *ikkinchi ajoyib limit* deb yuritiladi.

4 - misol.  $\lim_{x \rightarrow 0} \frac{a^x - 1}{x}$ , ( $a > 0, a \neq 1$ ) limitni hisoblaymiz.

Yechish.  $y = a^x - 1$  tenglik yordamida yangi o'zgaruvchi kiritamiz. U holda,  $x = \log_a(1 + y)$  bo'lgani uchun

$$\frac{a^x - 1}{x} = \frac{y}{\log_a(1+y)} \quad \text{yoki} \quad \frac{a^x - 1}{x} = \frac{y}{\frac{1}{y} \log_a(1+y)} = \frac{1}{\log_a(1+y)^y}$$

tenglik o'rinli bo'ladi.

$x \rightarrow 0$  da  $y \rightarrow 0$  ekanini va, aksincha,  $y \rightarrow 0$  da  $x \rightarrow 0$  ekanini ko'rish qiyin emas.

$\log_a(1+y)^{\frac{1}{y}}$  uzluksiz funksiya bo'lgani uchun (2) tenglikka

ko'ra  $\lim_{y \rightarrow 0} \log_a(1+y)^{\frac{1}{y}} = \log_a \left( \lim_{y \rightarrow 0} (1+y)^{\frac{1}{y}} \right) = \log_a e = \frac{1}{\ln a}$  teng-

likka egamiz. U holda

$$\lim_{x \rightarrow 0} \frac{a^x - 1}{x} = \lim_{y \rightarrow 0} \frac{1}{\log_a(1+y)^{\frac{1}{y}}} = \frac{1}{\lim_{y \rightarrow 0} \log_a(1+y)^{\frac{1}{y}}} = \ln a$$

4-misolni yechish jarayonida  $\lim_{y \rightarrow 0} \frac{\log_a(1+y)}{y} = \frac{1}{\ln a}$  tenglik ham isbotlanganligini eslatib o'tamiz.



## Mashqlar

**4.27.** Hisoblang:

1)  $\lim_{x \rightarrow 0} \frac{\sin 3x}{3x}$ ;

2)  $\lim_{x \rightarrow 0} \frac{\sin 6x}{4x}$ ;

3)  $\lim_{x \rightarrow 0} \frac{\operatorname{tg} 4x}{3x}$ ;

4)  $\lim_{x \rightarrow 0} \frac{\sin 5x}{\sin 6x}$ ;

5)  $\lim_{x \rightarrow 0} \frac{\operatorname{tg} 8x}{\operatorname{tg} 7x}$ ;

6)  $\lim_{x \rightarrow 0} x \operatorname{ctg} 6x$ .

**4.28.** Limitlarni hisoblang:

1)  $\lim_{x \rightarrow 0} \frac{\sin 13x}{13x}$ ;

2)  $\lim_{x \rightarrow 0} \frac{\sin 3x}{\sin 6x}$ ;

3)  $\lim_{x \rightarrow 0} \frac{\sin 16x}{12x}$ ;

4)  $\lim_{x \rightarrow 0} \frac{\operatorname{tg} 5x}{\operatorname{tg} 6x}$ ;

5)  $\lim_{x \rightarrow 0} \frac{\operatorname{tg} 8x}{7x}$ ;

6)  $\lim_{x \rightarrow 0} x \operatorname{ctg} 3x$ .

**4.29.** Limitlarni hisoblang:

1)  $\lim_{x \rightarrow 0} \frac{\operatorname{tg} 3x}{\sin 3x}$ ;

2)  $\lim_{x \rightarrow 0} \frac{\sin 4x}{2x \cos 3x}$ ;



3)  $\lim_{x \rightarrow 0} \frac{x \operatorname{tg} 3x}{\sin^2 2x}$ ;

4)  $\lim_{x \rightarrow 0} \frac{\sin 5x \operatorname{tg} 3x}{x^2}$ ;

5)  $\lim_{x \rightarrow 0} \frac{3x \cos 5x}{\sin 3x}$ ;

6)  $\lim_{x \rightarrow 0} \frac{2x \operatorname{tg} 4x}{\sin^2 6x}$ ;

7)  $\lim_{x \rightarrow 0} \frac{1 - \cos x}{5x^2}$ ;

8)  $\lim_{x \rightarrow 0} \frac{\arcsin 3x}{5x}$ ;

9)  $\lim_{x \rightarrow 0} \frac{\sqrt{1 - \cos 2x}}{|x|}$ ;

10)  $\lim_{x \rightarrow 0} \frac{5x}{\arctg x}$ ;

11)  $\lim_{x \rightarrow 0} \frac{\cos x - \cos^3 x}{x^2}$ ;

12)  $\lim_{x \rightarrow 0} \frac{x^2 \operatorname{ctg} x}{\sin 3x}$ ;

13)  $\lim_{x \rightarrow 0} \frac{1 - \cos 6x}{1 - \cos 2x}$ ;

14)  $\lim_{x \rightarrow 0} \frac{1 - \cos 4x}{2x \cdot \operatorname{tg} 2x}$ ;

15)  $\lim_{x \rightarrow 0} 5x \cdot \operatorname{ctg} 3x$ ;

16)  $\lim_{x \rightarrow 0} \frac{\sin 6x \operatorname{tg} 2x}{x^2}$ ;

17)  $\lim_{x \rightarrow 1} (1-x) \operatorname{tg} \frac{\pi x}{2}$ ;

18)  $\lim_{x \rightarrow \frac{\pi}{4}} \frac{\sin\left(\frac{\pi}{4} - x\right)}{\sin\left(\frac{3\pi}{4} + x\right)}$ ;

19)  $\lim_{x \rightarrow \pi} \sin 2x \operatorname{ctg} x$ ;

20)  $\lim_{x \rightarrow \frac{\pi}{2}} \frac{\sin\left(\frac{\pi}{2} - x\right)}{x - \frac{\pi}{2}}$ .

**4.30.** Limitlarni hisoblang:

1)  $\lim_{x \rightarrow 0} (1 + 3x)^{\frac{1}{x}}$ ;

2)  $\lim_{x \rightarrow 0} (1 + 7x)^{8x^{-1}}$ ;

3)  $\lim_{x \rightarrow 0} \frac{\ln(1+4x)}{x}$ ;

4)  $\lim_{x \rightarrow 0} \frac{\ln(1+9x)}{7x}$ .

## 1-§. Funksiyaning hosilasi va differensiali

**1. Funksiya orttirmasi.** Biz funksiyalar qiymatlari jadvallarini tuzish jarayonida funksiyaning  $\Delta f(x) = f(x_{i+1}) - f(x_i)$  chekli ayirmasi bilan tanishganmiz. Unda funksiya argumentning diskret qiymatlarida qaraldi, funksiya o'zining bir  $f(x_0)$  qiymatidan ikkinchi  $f(x_0 + \Delta x)$  qiymatiga sakrab o'tgandek bo'ladi, bunda  $\Delta x = h$  — jadval qadami. Endi biz argumentning uzluksiz o'zgarishiga bog'liq masalalarga o'tamiz.

To'g'ri chiziqli harakat qilayotgan nuqtaning  $x$  vaqt momentidagi koordinatasi (o'tilgan masofa)  $f(x)$  bo'lsin. Nuqta  $\Delta x = b - a$  vaqt oralig'ida  $|\Delta f(a)| = |f(b) - f(a)|$  qadar ko'chadi. Agar bunda  $\Delta f > 0$  bo'lsa, ko'chish musbat yo'nalishda,  $\Delta f < 0$  bo'lsa, ko'chish manfiy yo'nalishda bajarilgan bo'ladi.

$x_0 = a$  dan  $x$  ga ko'chishdagi  $\Delta x = h = x - a$  ayirma argumentning  $a$  nuqtadagi orttirmasi,  $\Delta f(a) = f(x) - f(a)$  ayirma funksiyaning shu nuqtadagi orttirmasi deyiladi.

**1 - misol.** Argumentning boshlang'ich qiymati  $a = 5$ , orttirmasi  $h = 0,1$ .  $f(x) = x^2$  funksiya orttirmasini topamiz.

**Yechish.** Argument  $a = 5$  dan  $h = 0,1$  ga ortgan:  $a + h = 5,1$ . U holda  $\Delta f(5) = f(5,1) - f(5) = 5,1^2 - 5^2 = 1,01$ .

**2 - misol.** Argument orttirmasi  $h$  ga teng.  $f(x) = kx + l$  chiziqli funksiya orttirmasini topamiz.

**Yechish.**  $f(a + h) = k(a + h) + l$ ;

$$\Delta f(a) = f(a + h) - f(a) = k(a + h) + l - ka - l = kh.$$

**3 - misol.** Kubning tomoni  $a$  ga teng. Agar tomonlar  $h$  qadar orttirilsa, uning hajmi qanday o'zgaradi?

**Yechish.** Tomonlar  $h$  ga orttirilgandan so'ng uning hajmi  $(a + h)^3$  ga teng bo'ladi. Natijada kubning hajmi

$$\Delta V = (a + h)^3 - a^3 = 3a^2h + 3ah^2 + h^3$$

ga ortadi.



## Mashqlar

**5.1.**  $x = a$  dan  $x = b$  ga o'tishda  $f$  funksiya qabul qiladigan orttirmaning fizik, geometrik ma'nosini tushuntiring, berilgan sonli ma'lumot bo'yicha orttirmani toping:

1)  $f(x)$  — o'tkazgichning ko'ndalang kesimidan  $x$  vaqtda o'tadigan elektr miqdori ( $a = 4$  s,  $b = 7$  s,  $f(x) = 5x$  Kl, Kulon);

2)  $f(x)$  — to'g'ri chiziqli harakat qilayotgan jismning  $x$  vaqt ichida o'tgan yo'li ( $a = 0$ ,  $b = 2$  s,  $f(x) = x^2 + 18x$  m);

3)  $f(x)$  — bir jinsli bo'lmagan sterjenning bir uchidan boshlab  $x$  uzunlikdagi qismining massasi ( $a = 0$ ,  $b = 0,35$  m,  $f(x) = 2x^2 + 3x$  kg).

**5.2.** Kubning qirrasi 1 sm (5 sm; 10 sm). Agar qirra 1 sm ga, 0,5 sm ga, 0,2 sm ga orttirilsa, kubning hajmi qanchaga ortadi?

**5.3.**  $[a; b]$  kesmada  $\Delta f(x)$  orttirma va  $\Delta x$  orttirmaning ishoralari bir xil. Shu kesmada funksiya o'suvchimi (kamayuvchimi)? Ishoralar har xil bo'lsa-chi?

**5.4.** Funksiyaning  $a$  nuqtadagi orttirimasini toping:

1)  $f(x) = 2x^2 - x$ ,  $a = 4$ ,  $h = 0,1$ ;

2)  $f(x) = -4 + 3x + x^2$ ,  $a = -2$ ,  $h = 0,01$ ;

3)  $f(x) = x - 2x^3$ ,  $a = 1$ ,  $h = -0,2$ .

**5.5.** Funksiya argumenti  $h$  orttirmani qabul qilib,  $x = b$  qiymatga erishgan.  $f$  funksiya orttirimasini toping, bunda:

1)  $f(x) = \sqrt{x-1}$ ,  $h = 1,65$ ,  $b = 9,41$ ;

2)  $f(x) = \sqrt{x+1}$ ,  $h = 2,65$ ,  $b = 7,41$ .

**5.6.** Doira radiusi  $R = 6$  sm, u  $h$  sm ga uzaytirilsa, doiraning yuzi qanchaga o'zgaradi? Bunda: 1)  $h = 0,3$  sm; 2)  $h = -0,3$  sm. Chizmada tasvirlang.

**2. Funksiya hosilasi.**  $y = x^2$  funksiya grafigining (1; 1) nuqta yaqinidagi holatini kuzataylik. V.1-a rasmda parabolaning  $h = 2$  uzunlikdagi  $[0; 2]$  kesma ustidagi qismi tasvirlangan. Chiziq o'z egriligi bilan shu nuqtadan o'tuvchi  $y = kx + l$  urinuvchi to'g'ri chiziqdan keskin farq qiladi. Shu nuqta atrofini kattaroq tasvirlaylik (V.1-b rasm). Parabolaning nisbatan kichik  $h = 0,2$  uzunlikka ega

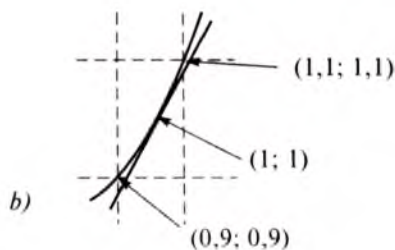
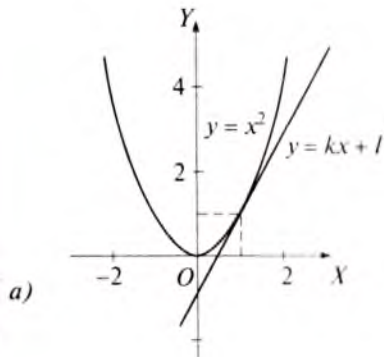

V.1-rasm.

bo'lgan  $[0,9; 1,1]$  kesmadagi qismi uncha egri emas.  $\Delta x = h$  ning yanada kichik qiymatlarida parabola va to'g'ri chiziq kesmalari deyarli ustma-ust tushadi, ya'ni parabola  $(1; 1)$  nuqta yaqinida «chiziqli kichik» holatida bo'ladi. U boshqa nuqtalar yaqinida ham shunday «chiziqli kichik» xossasiga ega bo'ladi. *Fizika nuqtayi nazaridan* «chiziqli kichiklik» xossasi mos fizik jarayon deyarli tekis, deyarli doimiy tezlik bilan ro'y berayotganini anglatadi. Matematikada «chiziqli kichik holatdagi funksiya» tushunchasi *differensiallanuvchi* nomi bilan ataladi (lot.: *differentia* – ayirma). Holatni matematik jihatdan tushuntiramiz.

Agar  $x = a$  dan  $x = a + h$  ga o'tishda  $f$  funksiya orttirmasini

$$\Delta f = f(a + h) - f(a) = (k + \alpha)h \quad (1)$$

ko'rinishda berish mumkin bo'lsa,  $f$  funksiya  $x = a$  da *differensiallanuvchi funksiya* deyiladi, bunda  $k$  – son,  $\alpha(x)$  funksiya  $\Delta x = h \rightarrow 0$  da cheksiz kichik,  $\lim_{h \rightarrow 0} \alpha(x) = 0$ .

Masalan,  $f(x) = kx + l$  chiziqli funksiya orttirmasi

$$\Delta f = f(a + h) - f(a) = k(a + h) + l - ka - l = kh,$$

ya'ni  $\alpha(x) = 0$  bo'lishini ko'ramiz. Demak, chiziqli funksiya  $x$  ning barcha qiymatlarida differensiallanadi.

Boshqa differensiallanuvchi funksiyalar uchun  $\Delta x$  va  $\Delta f$  orttirmalarning faqat taqribiy proporsionalligi o'rinli bo'ladi:

$$f(a + h) - f(a) \approx kh,$$

bundagi chetlanish  $\alpha(x)$  ga teng.

1 - misol.  $x^2$  funksiya  $x$  ning istalgan qiymatida differensiallanadi. Haqiqatan, funksiya  $x$  dan  $x + h$  ga o'tishda

$$\Delta f = (x + h)^2 - x^2 = (2x + h)h$$

orttirmaga ega, undagi  $2x$  ta'rif bo'yicha  $k$  ni,  $h$  esa  $\alpha$  funksiyani ifodalaydi,  $\lim_{h \rightarrow 0} \alpha = 0$ .

(1) tenglikdan:  $\frac{f(x+h)-f(x)}{h} = k + \alpha$ , bunda  $h = (x + h) - x = \Delta x$ ,  $\lim_{h \rightarrow 0} \alpha(x) = 0$ . Bularga ko'ra:

$$\lim_{h \rightarrow 0} \frac{f(x+h)-f(x)}{h} = k \quad (2)$$

va

$$\lim_{h \rightarrow 0} \alpha(x) = \lim_{h \rightarrow 0} \left( \frac{f(x+h)-f(x)}{h} - k \right) = 0.$$

Aksincha, bu limitli ifodadan (1) tenglikni hosil qilish mumkin. Shu tariqa ushbu teorema isbot qilinadi.

**Teorema.**  $k = \lim_{h \rightarrow 0} \frac{f(x+h)-f(x)}{h}$  limit mavjud bo'lgandagina  $f(x)$  funksiya differensiallanadi va uning orttirmasi

$$\Delta f = f(x+h) - f(x) = (k + \alpha)h$$

bo'ladi, bunda  $\lim_{h \rightarrow 0} \alpha(x) = 0$ .

$\Delta f = (k + \alpha)h$  tenglik funksiyaning differensiallanishini xarakterlaydi. Masalan,  $v$  doimiy tezlik bilan to'g'ri chiziqli tekis harakat qilayotgan jism  $t$  vaqtda  $s = vt + s_0$  masofani bosib o'tsin, bunda  $s_0$  - harakat boshlanguncha o'tilgan masofa,  $s$  bog'lanish  $y = kx + l$  funksiyaning o'zi,  $k = v$ ,  $x = t$ ,  $l = s_0$ ,  $y = s$ . Mexanika nuqtayi nazaridan  $k$  son *harakat tezligi*, geometrik jihatdan to'g'ri chiziqning *burchak koeffitsiyenti* miqdorini ifodalaydi.  $k$  ning qiymati  $x$  ga bog'liq. Demak,  $k$  son biror funksiyaning xususiy qiymatidan iborat. Bu funksiya  $f(x)$  funksiyaning *hosilasi* deb ataladi va  $f'(x)$  orqali belgilanadi.

$f'(x)$  ning  $x$  nuqtadagi qiymati ushbu formula bo'yicha topiladi:

$$f'(x) = \lim_{h \rightarrow 0} \frac{f(x+h)-f(x)}{h} = \lim_{h \rightarrow 0} \frac{\Delta f}{h}, \quad (3)$$

bunda  $\Delta x = h$  - argument orttirmasi.

Shunday qilib, funksiya orttirmasi  $f(x+h) - f(x) = (k + \alpha)h$  ko'rinishda berilgan bo'lsa,  $k$  son hosilaning qiymatini beradi.

Jism  $t = t_0$  boshlang'ich vaqt momentida  $f(t_0)$  koordinatali nuqtada,  $t = t_0 + \Delta t$  momentda  $f(t_0 + \Delta t)$  koordinatali nuqtada bo'lsin.  $[t_0; t_0 + \Delta t]$  vaqt oralig'ida  $\Delta f = f(t_0 + \Delta t) - f(t_0)$  masofani o'rtacha  $v_{o'rt} (t) = \frac{\Delta f}{\Delta t}$  tezlik bilan o'tadi, bunda  $\Delta t = (t_0 + \Delta t) - t_0$  o'tgan vaqt. O'rtacha tezlikning  $\Delta t \rightarrow 0$  dagi limiti, ya'ni  $f'(t_0)$  hosila to'g'ri chiziqli harakatning  $t_0$  momentdagi *oniy (bir lahzadagi) tezligini* ifodalaydi:

$$v_{oniy} (t_0) = \lim_{\Delta t \rightarrow 0} \frac{\Delta f}{\Delta t} = f'(t_0).$$

Bir jinsli sterjenning  $x$  uzunlikdagi qismining massasi  $f(x) = kx$ , bunda  $k$  son - sterjenning *chiziqli zichligi*. Agar sterjen bir jinsli bo'lmasa, uning  $h$  uzunlikdagi  $AB$  qismining massasi  $f(x_0 + h) - f(x_0)$  bo'ladi, bunda  $x_0$  qiymat sterjenning  $A$  boshlang'ich uchining koordinatasi.  $AB$  qismning o'rtacha zichligi:

$$k_{o'rt} (t) = \frac{f(x_0+h) - f(x_0)}{h} = f'(x_0) + \alpha,$$

bunda  $x_0$  nuqtadagi *chiziqli zichlik*  $k(x_0) = \lim_{h \rightarrow 0} k_{o'rt} (t) = f'(x_0)$  bo'ladi.

Har qanday  $l$  doimiy sonning hosilasi nolga teng. Chunki,  $l = 0 \cdot x + l$  yozuvi bo'yicha  $k = l' = 0$  ni olamiz. Demak,  $(kx + l)' = k$ . Lekin  $(x^2)' = 2x$  bo'ladi. Chunki  $f(x+h) - f(x) = (x+h)^2 - x^2 = (2x + h)h$  bo'lganidan,  $(k + \alpha)h$  yozuv bo'yicha  $k = 2x$  olinadi.

$[a; b]$  yopiq kesmaning  $a$  nuqtasida  $f$  funksiyaning o'ng tomonli,  $b$  nuqtasida esa chap tomonli differensiallanish i haqida so'z borishi mumkin:

$$f'(a+0) = \lim_{h \rightarrow +0} \frac{f(a+h) - f(a)}{h}, \quad f'(b-0) = \lim_{h \rightarrow -0} \frac{f(b-h) - f(b)}{h}.$$

2 - misol. (3) formuladan foydalanib,  $f(x) = \frac{a}{x}$  funksiya hosilasini topamiz, bunda  $a$  - biror doimiy son,  $\Delta x = h$ ,  $\Delta y = f(x + \Delta x) - f(x)$ ,  $x \neq 0$ .

Yechish.  $\Delta y = \frac{a}{x+\Delta x} - \frac{a}{x} = \frac{ax - ax - a \cdot \Delta x}{x(x+\Delta x)} = -\frac{a \cdot \Delta x}{x(x+\Delta x)}$ , u holda:

$$\left(\frac{a}{x}\right)' = \lim_{\Delta x \rightarrow 0} \left(-\frac{a}{x(x+\Delta x)}\right) = -\frac{a}{x^2}.$$

3 - misol. 1)  $y = x$ ; 2)  $y = x^2$ ; 3)  $y = ax^2 + bx + c$ ; 4)  $y = x^3$  funksiyalarning hosilalarini topamiz.

Yechish. 1)  $y = x = 1 \cdot x + 0$ , bundan  $k = y' = 1$ , ya'ni  $x' = 1$  bo'lishini aniqlaymiz. Bu misolda (3) kabi limit formulalardan foydalanishga hojat bo'lmadi;

2) (1) formula bo'yicha:

$$\Delta y = (x + \Delta x)^2 - x^2 = x^2 + 2x \cdot \Delta x + (\Delta x)^2 - (\Delta x)^2 = (2x + \Delta x) \cdot \Delta x.$$

Orttirma  $\Delta y = (k + \alpha) \cdot \Delta x$  ko'rinishda tasvirlandi. Unda

$$\lim_{x \rightarrow 0} \alpha = 0, k = 2x. \text{ Demak, } (x^2)' = 2x;$$

3) funksiya orttirmasi:

$$\begin{aligned} \Delta y &= a(x + \Delta x)^2 + b(x + \Delta x) + c - (ax^2 + bx + c) = \\ &= 2ax \cdot \Delta x + a(\Delta x)^2 + b \cdot \Delta x. \end{aligned}$$

Funksiya orttirmasining argument orttirmasiga nisbati:

$$\frac{\Delta y}{\Delta x} = \frac{(2ax + a \cdot \Delta x + b) \cdot \Delta x}{\Delta x} = 2ax + a \cdot \Delta x + b;$$

topilgan nisbatning  $\Delta x \rightarrow 0$  dagi limiti:

$$y' = \lim_{\Delta x \rightarrow 0} (2ax + a \cdot \Delta x + b) = 2ax + b.$$

Demak,  $(ax^2 + bx + c)' = 2ax + b$ ;

$$4) \Delta(x^3) = (x + \Delta x)^3 - x^3 = (3x^2 + 3x \cdot \Delta x + (\Delta x)^2) \cdot \Delta x,$$

$$y' = \lim_{\Delta x \rightarrow 0} \frac{\Delta y}{\Delta x} = \lim_{\Delta x \rightarrow 0} (3x^2 + 3x \cdot \Delta x + (\Delta x)^2) = 3x^2.$$



## Mashqlar

5.7. Funksiyalarning differensiallanishini isbot qiling:

$$1) \sqrt{x}, x > 0; \quad 2) -\frac{1}{x}, x \neq 0; \quad 3) \frac{1}{x-5}, x \neq 5;$$

$$4) -\frac{1}{\sqrt{x}}, x > 0; \quad 5) -\frac{1}{x^2}, x \neq 0; \quad 6) x^4.$$

**5.8.** 5.4-mashqda keltirilgan funksiyalar hosilalarini toping.

**5.9.** Funksiyalarning hosilalarini toping:

1)  $\frac{4}{9}x - 1$ ;                      2)  $5 - 7x^2$ ;                      3)  $\sqrt{7x}$ ;

4)  $2 + \sqrt{7x}$ ;                      5)  $x^3 + \sqrt{3}$ ;                      6)  $5x^2$ ;

7)  $-\frac{x^2}{6}$ ;                              8)  $-x^3 + 7$ ;                      9)  $\sqrt{x}$ ;

10)  $\sqrt{x+1}$ ;                      11)  $(x^2 - x + 1)^2$ .

**5.10.**  $f(x)$  funksiya  $f'(x)$  hosilasining  $x = a$  nuqtadagi qiymatini toping:

1)  $4 - 5x^2$ ,  $a = 1$ ;

2)  $\sqrt[3]{4 + \sqrt{6x}}$ ,  $a = \frac{8}{3}$ ;

3)  $x^3$ ,  $a = -1$ ,  $a = 3$ ,  $a = -0,5$ .

**5.11.**  $f(x) = x^3 - \frac{3}{5}x^2 + 10x - 2$ ,  $f'(0) = ?$   $f'(-1) = ?$   $f'(1) = ?$

**5.12.**  $x$ ,  $x^2$ ,  $x^3$ ,  $\frac{1}{x}$ ,  $\sqrt{x}$  funksiyalar hosilalarini kuzating, ularning tuzilishida qanday umumiylik bor?

**5.13.**  $y = \sqrt[3]{x}$  funksiya hosilasini toping.

**5.14.** Jismning aylanma harakatida  $\omega$  burchak tezligi va  $v$  chiziqli tezligi orasidagi bog'lanish  $\omega = \frac{v}{R}$  munosabat orqali ifodalanadi,  $R$  — aylana radiusi. Oniy burchak tezlik tushunchasini ta'riflang va uning ifodasini hosila orqali bering.

**5.15.** Qattiq jismning issiqlikdan chiziqli kengayishi  $l_t - l_0 = a l_0(t - t_0)$ , bog'lanish orqali ifodalanadi, bunda  $l_0$  va  $l_t$  jismning  $t_0$  va  $t$  temperaturalardagi uzunligi,  $a$  — jismning issiqlikdan chiziqli kengayish koeffitsiyenti (jism moddasining tabiatiga va turiga bog'liq kattalik). Oniy chiziqli kengayish tushunchasini ta'riflang va uning ifodasini hosila orqali bering.

**5.16.**  $h_0$  balandlikdan  $v_0$  boshlang'ich tezlik bilan yuqoriga tik otilgan jism  $h(t) = h_0 + v_0 t - \frac{gt^2}{2}$  qonun bo'yicha harakat qilmoqda. Agar  $h_0 = 5$  m,  $v_0 = 2,5$  m/s,  $g \approx 10$  m/s<sup>2</sup> bo'lsa, jismning tezligi uning  $v_0$  tezligidan 5 marta kichik bo'lgan vaqt momentidagi balandligini toping.

**5.17.**  $t = 0$  momentdan boshlab o'tkazgich orqali o'tgan elektr miqdori  $q(t) = 2,5t^2 - 3t$  formula bo'yicha hisoblanadi. Ixtiyoriy



vaqt momentidagi tok kuchini hisoblash uchun formula chiqaring va 5-sekund oxiridagi tok kuchini hisoblang.

**3. Funksiya differensial.** Agar  $y = f(x)$  funksiya orttirmasi uchun tuzilgan  $\Delta y = f(x + \Delta x) - f(x) = (k + \alpha) \cdot \Delta x$  formulaga  $k = f'(x)$  qiymat qo'yilsa, so'ng  $\lim_{\Delta x \rightarrow 0} \alpha = 0$  bo'lgani uchun  $f(x + \Delta x) - f(x) \approx f'(x) \cdot \Delta x$  yoki

$$f(x + \Delta x) \approx f(x) + f'(x) \cdot \Delta x \quad (1)$$

taqribiy formulaga ega bo'lamiz. Bu munosabatdagi  $f'(x) \cdot \Delta x$  qo'shiluvchi  $y = f(x)$  funksiyaning berilgan  $x$  qiymatdagi *differensial* deyiladi va  $dy$  yoki  $df(x)$  orqali belgilanadi, ya'ni

$$dy = f'(x) \cdot \Delta x. \quad (2)$$

$x$  erkli o'zgaruvchining  $dx$  differensialini topaylik.  $x' = 1$  va  $y = x$  bo'lishini nazarda tutib, (2) munosabat bo'yicha  $dx = f'(x) \cdot \Delta x = x' \cdot \Delta x = 1 \cdot \Delta x = \Delta x$ , ya'ni  $dx = \Delta x$  ni olamiz. (2) munosabat

$$df(x) = f'(x) dx \quad (3)$$

ko'rinishga keladi. Shu kabi, (1) munosabatga muvofiq  $f(x)$  funksiyaning  $x = a$  nuqta yaqinidagi qiymati uning shu nuqtadagi  $f(a)$  qiymati bilan  $f'(a) \cdot h$  differensialining yig'indisiga teng, bunda  $\Delta x = h$ .

$y = f(x)$  funksiya biror oraliqda uzluksiz va qat'iy monoton bo'lsin. U holda unga *teskari*  $x = \varphi(y)$  funksiya mavjud,  $\Delta y = f(x + \Delta x) - f(x) \neq 0$  da  $\Delta x = \varphi(y + \Delta y) - \varphi(y) \neq 0$  va  $\Delta x \rightarrow 0$  da  $\Delta y \rightarrow 0$ ,  $\Delta y \rightarrow 0$  da  $\Delta x \rightarrow 0$  bo'ladi. Natijada:  $\lim_{\Delta y \rightarrow 0} \frac{\Delta x}{\Delta y} = \frac{1}{\lim_{\Delta x \rightarrow 0} \frac{\Delta y}{\Delta x}}$  yoki

$$\varphi'(y) = \frac{1}{f'(x)} \quad (4)$$

va

$$dx = d\varphi(y) = \varphi'(y) dy \quad (5)$$

munosabatlarga ega bo'lamiz.

(1) formula taqribiy hisoblashlarda keng qo'llaniladi.

**Misol.**  $y = x^3$  funksiyaning  $x = 3,0184$  dagi qiymatini  $\varepsilon = 0,005$  gacha aniqlikda topamiz.

**Yechish.**  $3,0184 = 3 + 0,0184$ . Shunga ko'ra,  $a = 3$ ,  $h = 0,0184$  deb olishimiz mumkin.  $f(3) = 3^3 = 27$ ,  $f'(3) = 3x^2 = 27$ . (1) munosabat bo'yicha  $f(x + \Delta x) = (3 + 0,0184)^3 \approx 27 + 27 \cdot 0,0184 = 27,4968$ . Vujudga keladigan xatolik:

$$(x + \Delta x)^3 - (x^3 + 3x^2 \cdot \Delta x) = 3x(\Delta x)^2 + (\Delta x)^3 = 3 \cdot 3 \cdot 0,0184^2 + 0,0184^3 = \\ = 0,0184^2 \cdot 9,0184 < 0,02^2 \cdot 9,02 = 0,003608 < 0,004 < \varepsilon.$$



## Mashqlar

**5.18.**  $f(x)$  funksiyaning  $x = a$  dan  $x = b$  ga o'tishdagi chekli ayirmasi, ortirmasi, hosilasi, differensiali tushunchalarining ma'nosini fizik va geometrik misollar yordamida tushuntiring.

**5.19.** Differensiallarni toping:

1)  $d\left(\frac{4}{9}x\right)$ ; 2)  $d\sqrt{x}$ ; 3)  $d(5x^2)$ ; 4)  $d(\sqrt[3]{x})$ ; 5)  $d(kx + l)$ .

**5.20.** Taqribiy hisoblang:

1)  $\sqrt{7,9}$ ; 2)  $\sqrt{56}$ ; 3)  $\sqrt[3]{46}$ ; 4)  $\sqrt[3]{24,7}$ .

**4. Funksiya grafigiga urinuvchi to'g'ri chiziq.**  $y = f(x)$  funksiya grafigida yotgan  $M(x_0; y_0)$  va  $N(x_1; y_1)$  nuqtalar ustidan kesuvchi (a) to'g'ri chiziqni o'tkazaylik (V.2-rasm). Uning tenglamasi:

$$\frac{y - y_0}{y_1 - y_0} = \frac{x - x_0}{x_1 - x_0}$$

yoki

$$y = \frac{y_1 - y_0}{x_1 - x_0} (x - x_0) + y_0, \quad (1)$$

bo'ladi, bunda  $\Delta x = x_1 - x_0 = h$ ,  $dy = y_1 - y_0 = f(x_0 + h) - f(x_0)$ ,  $N$  nuqtani qo'zg'almas  $M$  nuqta tomon  $f(x)$  chiziq bo'yicha siljitsak, (a) kesuvchi  $M$  nuqta atrofida burilib harakatlanadi va  $M$  nuqtadan o'tuvchi (b) urinmaga yaqinlashadi. Urinma esa og'ma bo'lsin, u holda  $\Delta x = x_1 - x_0$  oraliq qisqaradi. Bunga qaraganda  $\cup NM \rightarrow 0$  yoki  $\Delta x \rightarrow 0$  da (a) kesuvchi (b) *urinma holatida* bo'ladi.

Natijada (a) to'g'ri chiziq  $k_{\text{kes.}}$  burchak koeffitsiyentining  $NM \rightarrow 0$  dagi limiti (b) urinmaning  $k_{\text{urin.}} = \text{tg} \varphi$  burchak koeffitsiyentiga teng bo'ladi.  $k_{\text{kes.}} = \frac{f(x_0 + h) - f(x_0)}{h}$  bo'lganidan quyidagilarga ega bo'lamiz:

$$k_{\text{urin.}} = \lim_{h \rightarrow 0} \frac{f(x_0 + h) - f(x_0)}{h} = f'(x_0)$$

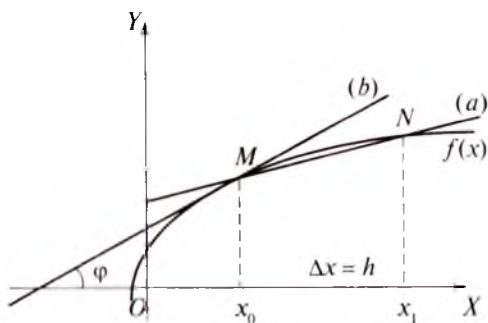

V.2-rasm.

va

$$y = f(x_0) + f'(x_0)(x - x_0). \quad (2)$$

Bu mulohazalarda urinma og'ma, ya'ni  $\varphi \neq 90^\circ$  deb olindi. Urinma vertikal bo'lgan holda  $\operatorname{tg} 90^\circ = +\infty$ .

**Misol.** Absissasi  $x = -3$  bo'lgan nuqtada  $y = 9 - x^2$  egri chiziqqa urinuvchi to'g'ri chiziq tenglamasini tuzamiz.

**Yechish.** (2) formuladan foydalanamiz. Bizda  $f'(x) = (9 - x^2)' = -2x$ ,  $k = f'(-3) = -2 \cdot (-3) = 6$ . U holda  $y = (9 - (-3)^2) + 6 \cdot (x - (-3)) = 6x + 18$ .



## Mashqlar

**5.21.** Absissasi  $x_0 = 1$  bo'lgan nuqtada  $y = 2x^2$  egri chiziqqa urinuvchi to'g'ri chiziqning tenglamasini tuzing.

**5.22.** Ordinatasi  $y_0 = -2$  bo'lgan nuqtada  $y = x^2 - 4x + 1$  egri chiziqqa urinuvchi to'g'ri chiziqning tenglamasini tuzing.

**5.23.**  $y = -2x + 6$  to'g'ri chiziqqa parallel bo'lgan va  $y = x^2 - 6x + 5$  parabolaga urinuvchi to'g'ri chiziqning tenglamasini tuzing.

**5.24.**  $B(2; -5)$  nuqtadan o'tib,  $y = x^2 - 6x + 5$  parabolaga urinuvchi to'g'ri chiziqning tenglamasini tuzing.

**5. Differensiallanuvchi funksiyaning uzluksizligi.** Oldingi boblardan funksiyaning uzluksizligi haqida bir qadar ma'lumotga egamiz.  $f(x)$  funksiyaning  $x = a$  nuqtada uzluksiz bo'lishi uchun:

1)  $f(a) = b$ , unda  $b$  — aniq qiymat; 2)  $\lim_{x \rightarrow a} f(x) = b$  bo'lishi

kerak. Bu shartlardan aqalli biri bajarilmay qolsa, funksiya  $x = a$

nuqtada uziladi. Masalan,  $f(x) = \frac{1}{x-1}$  funksiya  $x = 2$  nuqtada uzluksiz. Chunki  $f(2) = 1$ ,  $\lim_{x \rightarrow 2} f(x) = 1$ . Lekin u  $x = 1$  da uziladi:

1-shart bajarilmaydi (funksiya aniq qiymatga ega emas). Uning grafigiga, masalan, (1; 3) nuqta kiritilishi bilan tuziladigan ushbu

$$g(x) = \begin{cases} \frac{1}{x-1}, & \text{agar } x \neq 1 \text{ bo'lsa,} \\ 3, & \text{agar } x = 1 \text{ bo'lsa} \end{cases}$$

funksiya ham uzilishga ega: endi 1-shart bajariladi, 2-shart esa bajarilmaydi:  $\lim_{x \rightarrow 1} \frac{1}{x-1} = \infty$  (cheksiz limit). Masalani oydinlashtirish maqsadida ushbu teoremadan foydalanamiz:

**Teorema.** *Agar  $f(x)$  funksiya  $x = a$  nuqtada differensiallan-  
sa, u shu nuqtada uzluksizdir.*

**Isbot.**  $a$  nuqtada  $f$  funksiya differensiallansin:  $f(a+h) - f(a) = (k + \alpha)h$ . Lekin  $h \rightarrow 0$  da  $\alpha \rightarrow 0$  va  $\lim_{h \rightarrow 0} (k + \alpha)h = (k + 0) \cdot 0 = 0$ .

Bundan  $\lim_{h \rightarrow 0} (f(a+h) - f(a)) = 0$  yoki  $\lim_{h \rightarrow 0} (f(a+h)) = f(a)$ .

Bu esa  $f$  funksiyaning  $x = a$  nuqtada uzluksizligini bildiradi.

Teskari fikr noto'g'ri, funksiya biror nuqtada uzluksiz bo'lsa-da unda differensiallanmasligi ham mumkin. Masalan,  $|x|$  funksiya barcha nuqtalarda uzluksiz, lekin  $x = 0$  da differensiallanmaydi.

Haqiqatan, funksiya ifodasini  $|x| = \begin{cases} x, & \text{agar } x \geq 0 \text{ bo'lsa,} \\ -x, & \text{agar } x < 0 \text{ bo'lsa} \end{cases}$  ko'ri-

nishda yozaylik. Funksiyaning  $x = 0$  nuqtadagi o'ng tomonli va chap tomonli limitlari teng:

$$\lim_{x \rightarrow +0} |x| = \lim_{x \rightarrow +0} x = 0, \quad \lim_{x \rightarrow -0} |x| = \lim_{x \rightarrow -0} (-x) = 0.$$

Demak,  $|x|$  funksiya  $x = 0$  nuqtada uzluksiz. Lekin u shu nuqtada differensiallanadimi? Ixtiyoriy  $x = h$  da  $y = |x| = |h|$ ,

$x = 0$  da  $y = |x| = 0$ ,  $\lim_{h \rightarrow +0} \frac{|h|}{h} = \lim_{h \rightarrow +0} \frac{h}{h} = 1$ ,  $\lim_{h \rightarrow -0} \frac{|h|}{h} = -1$ , ya'ni hosila qiymatini berishi kerak bo'lgan o'ng va chap tomonli limitlar

teng emas. Demak,  $x=0$  nuqtada  $|x|$  funksiyaning hosilasi mavjud emas, funksiya bu nuqtada differensiallanmaydi, grafigi o'z yo'nalishini o'zgartiradi.



## Mashqlar

**5.25.** Quyidagi funksiyalarning  $x=a$  nuqtada uzluksizligi, lekin unda differensiallanmasligini isbot qiling:

1)  $f(x)=|x-3|$ ,  $a=3$ ;                      2)  $f(x)=x+|x-2|$ ,  $a=2$ ;

3)  $f(x)=\sqrt[3]{x^2}$ ,  $a=0$ .

**5.26.** Quyidagi funksiyalar  $x=0$  nuqtada differensiallanadimi?

1)  $f(x)=\frac{3|x|}{x}$ ;                      2)  $f(x)=-2|x|$ ;                      3)  $f(x)=\frac{x}{4}$ ;

4)  $f(x)=\frac{x^2}{4}$ ;                      5)  $f(x)=\begin{cases} x^2, & \text{agar } x \leq 0 \text{ bo'lsa,} \\ x, & \text{agar } x > 0 \text{ bo'lsa.} \end{cases}$

**5.27.** Funksiyalarning qaysi biri sonlar o'qida uzluksiz?

1)  $f(x)=|x^2-4|$ ;                      2)  $f(x)=-\frac{|x|}{x}$ ;

3)  $f(x)=\begin{cases} x-2, & \text{agar } x \leq 0 \text{ bo'lsa,} \\ x^2-2, & \text{agar } x > 0 \text{ bo'lsa;} \end{cases}$

4)  $f(x)=\begin{cases} x-2, & \text{agar } x \leq 0 \text{ bo'lsa,} \\ x^2, & \text{agar } x > 0 \text{ bo'lsa.} \end{cases}$

**5.28.**  $f(x)=\begin{cases} x^2, & \text{agar } x \leq 1 \text{ bo'lsa,} \\ ax+b, & \text{agar } x > 1 \text{ bo'lsa} \end{cases}$  funksiya  $a$  va  $b$  ning

qanday qiymatlarida  $x=1$  nuqtada differensiallanadi?

## 2-§. Funksiyani differensiallash qoidalari

**1. Chiziqli kombinatsiyalarni differensiallash.**  $f$  funksiyaning

biror  $x$  nuqtada differensiallanishi uchun  $f'(x) = \lim_{h \rightarrow 0} \frac{f(x+h)-f(x)}{h}$  limitning albatta mavjud bo'lishi zarur ekanligini bilamiz.  $f'(x)$

hosilani topish  $f(x)$  funksiyani differensiallash deyiladi. Funksiya differensial  $df(x) = f'(x)dx$  ko'paytmaga tengligini bilamiz. Differensiallash masalasi  $f'(x)$  hosilani topishga keladi. Quyida biz differensiallash qoidalari bilan tanishar ekanmiz, unda qaralayotgan funksiya hosilaga ega deb qabul qilinadi.

1 - teorema.  $C$  doimiy ko'paytuvchini hosila belgisi ostidan chiqarish mumkin:

$$(Cf(x))' = Cf'(x). \quad (1)$$

Isbot.  $\Delta(Cf(x)) = Cf(x+h) - Cf(x) = C(f(x+h) - f(x)) = C \cdot \Delta f$ . Bundan:  $\lim_{h \rightarrow 0} \frac{C \cdot \Delta f}{h} = C \lim_{h \rightarrow 0} \frac{\Delta f}{h} = Cf'$ .

2 - teorema.  $f$  va  $g$  funksiyalar differensiallanadigan nuqtalarda  $f + g$  funksiya ham differensiallanadi va

$$(f(x) + g(x))' = f'(x) + g'(x) \quad (2)$$

bo'ladi.

Isbot.  $f(x) + g(x)$  funksiyaning  $[x; x+h]$  kesmada qabul qiladigan orttirmasi:

$$\begin{aligned} \Delta(f(x) + g(x)) &= (f(x+h) + g(x+h)) - (f(x) + g(x)) = \\ &= (f(x+h) - f(x)) + (g(x+h) - g(x)) = \Delta f(x) + \Delta g(x), \end{aligned}$$

bundan  $\frac{\Delta(f(x)+g(x))}{h} = \frac{\Delta f(x)}{h} + \frac{\Delta g(x)}{h}$ . Tenglikning ikkala tomonida  $h \rightarrow 0$  da limitga o'tsak,

$$\lim_{h \rightarrow 0} \frac{\Delta(f(x)+g(x))}{h} = \lim_{h \rightarrow 0} \frac{\Delta f(x)}{h} + \lim_{h \rightarrow 0} \frac{\Delta g(x)}{h};$$

chap tomondagi limit  $(f(x) + g(x))'$  ga, o'ng tomondagi limit  $f'(x) + g'(x)$  ga teng. Demak,  $(f(x) + g(x))' = f'(x) + g'(x)$ .

1 - misol.  $f(x) = -x^3 - 5x^2 + \frac{4}{9}x + 7$  funksiyaning hosilasini topamiz.

Yechish.  $f'(x) = (-x^3)' + (-5x^2)' + \left(\frac{4}{9}x\right)' + 7'$ ;  $(-x^3)' = -3x^2$ ,  $(-5x^2)' = -5 \cdot 2x = -10x$ ,  $\left(\frac{4}{9}x\right)' = \frac{4}{9}$ ,  $7' = 0$ . Bundan,  $f'(x) = -3x^2 - 10x + \frac{4}{9}$ .

2 - misol. Absissasi  $x_0 = 1$  bo'lgan nuqtada  $f(x) = 2x^2 - 3x$  funksiya grafigiga urinuvchi to'g'ri chiziq tenglamasini tuzamiz.

Yechish. Bizda  $f(1) = 2 \cdot 1^2 - 3 \cdot 1 = -1$ ,  $f'(x) = (2x^2 - 3x)' = 2 \cdot 2x - 3 = 4x - 3$ , bundan  $f'(1) = 4 \cdot 1 - 3 = 1$ . Bu qiymatlar urinmaning  $y = f(x_0) + f'(x_0)(x - x_0)$  tenglamasiga qo'yilsa,  $y = -1 + 1 \cdot (x - 1) = x - 2$  yoki  $y = x - 2$  hosil qilinadi.

3 - misol. Jismning erkin tushishda o'tadigan masofasi  $s = \frac{gt^2}{2}$  formula bo'yicha topiladi. Tushishning  $t_0 = 1$  s; 2 s dagi oniy tezligini topamiz ( $g \approx 10$  m/s<sup>2</sup>).

Yechish. Oniy tezlik  $v(t_0) = s'(t_0)$  ga teng, bunda

$$s'(t) = \left( \frac{gt^2}{2} \right)' = \frac{g}{2} (t^2)' = \frac{g}{2} \cdot 2t = gt.$$

U holda  $v(1) = g \cdot 1 \approx 10$  m/s,  $v(2) \approx 10 \cdot 2 = 20$  m/s.



## Mashqlar

**5.29.**  $f$  funksiya uchun  $[a - h; a + h]$  kesmada tuzilgan  $\frac{f(a+h)-f(a)}{h}$ ,  $\frac{f(a)-f(a-h)}{h}$ ,  $\frac{f(a+h)-f(a-h)}{2h}$  va  $f'(a)$  ifodalarning qiymatlarini (mikrokalkulator yoki EHM yordamida) hisoblang, bunda uchinchi kasr ifodaning qiymati, ya'ni birinchi va ikkinchi kasrlarning o'rta arifmetigi  $f'(a)$  uchun yaxshiroq yaqinlashish bo'lishini tekshirib ko'ring ( $h = 0,1; 0,01; 0,001$ ):

1)  $f(x) = x^3 - 2x^2 + 4$ ,  $a = 3$ ;      2)  $f(x) = 3\sqrt{x} - 6x$ ,  $a = 9$ .

**5.30.** Funksiyalarning hosilalarini toping:

1)  $x^3 - 4\sqrt{x} + x - 5$ ;      2)  $-2x^3 + 3x^2 + 4$ ;

3)  $5x^2 + 3\sqrt{x} - 4$ ;      4)  $\frac{3}{x} + \sqrt{x}$ .

**5.31.**  $x_0 = 1$  nuqtada  $y = 2x^3$  egri chiziqqa urinuvchi to'g'ri chiziq tenglamasini tuzing va uning shu urinish nuqtasidan absissalar o'qi bilan kesishuvigacha uzunligini toping.

**5.32.** Absissasi  $x_0 = 2$  bo'lgan nuqtada  $y = 3x^3 - 6x^2 - 4$  egri chiziqqa o'tkazilgan urinmaning tenglamasini tuzing.

**5.33.** Ordinatasi  $y_0 = -2$  bo'lgan nuqtada  $y = x^3 - 1\frac{3}{4}x - 1\frac{1}{4}$  egri chiziqqa o'tkazilgan urinuvchi to'g'ri chiziq tenglamasini tuzing.



**5.34.**  $x_0 = -3$  nuqtada  $y = x^2 + 6x + 5$  parabola ga urinuvchi to'g'ri chiziqning burchak koeffitsiyenti va  $OX$  o'qi bilan kesishish nuqtasini toping.

**5.35.**  $y = x^2 - 9$  parabola ga uning absissalar o'qi bilan kesishish nuqtalarida urinuvchi to'g'ri chiziqning burchak koeffitsiyentlari va ordinatalar o'qi bilan kesishish nuqtalarini toping.

**5.36.** Jism  $h_0$  balandlikdan  $v_0$  boshlang'ich tezlik bilan yuqoriga tik otilgan. Uning  $t$  vaqt momentidagi o'ny tezligini toping.

**5.37.** 60 sm uzunlikdagi bir jinsli yupqa  $AB$  sterjenning massasi  $m = 4x^2$  (g larda) qonun bo'yicha taqsimlangan. Sterjenning  $A$  uchidan  $x_0 = 20$  sm va  $x_0 = 50$  sm uzoqlikda turgan nuqtalardagi chiziqli zichlikni toping.

**5.38.** O'tkazgich orqali  $t = 0$  vaqt momentidan boshlab o'tadigan elektr miqdori  $q(t) = 5t^3 - 1$  formula bo'yicha topiladi.  $t$  vaqt momentidagi tok kuchining kattaligini toping.

**5.39.** Jism  $s(t) = 10t + t^2$  qonun bo'yicha to'g'ri chiziqli harakat qilmoqda. Uning  $t = 2; 5; 7$  (s) vaqt momentidagi o'ny tezligini toping.

**5.40.**  $y = 1 - 1,5x - x^2$  parabola bilan  $OY$  o'qining kesishish nuqtasida shu parabola ga urinuvchi to'g'ri chiziqning tenglamasini tuzing.

**5.41.** Nuqtaning koordinatalar to'g'ri chizig'i bo'ylab harakat qonuni  $x = 2 + 10t - 0,3t^2$  (m) tenglama bilan ifodalanadi. Nuqtaning  $t_0 = 6$  (s) momentdagi tezligini toping. Harakat qachon to'xtaydi?

**5.42.** Nuqtaning koordinatalar to'g'ri chizig'i bo'yicha harakat qonuni  $x = t^3 - 6t^2 + 4$  (m) tenglama bilan ifodalanadi. Qaysi vaqt momentida tezlik 0 ga, 5 ga, 6 ga teng bo'ladi?

**2. Darajali funksiyani va funksiyalar ko'paytmasini differensiallash.** Agar geometrik progressiya hadlari yig'indisi uchun ushbu

$1 + x + x^2 + \dots + x^{n-1} = \frac{x^n - 1}{x - 1}$ ,  $x \neq 1$  tenglikka  $x = \frac{b}{a}$  qo'yilsa, natijada

$$1 + \frac{b}{a} + \frac{b^2}{a^2} + \dots + \frac{b^k}{a^k} + \dots + \frac{b^{n-1}}{a^{n-1}} = \frac{b^n - 1}{\frac{b}{a} - 1} = \frac{b^n - a^n}{a^{n-1}(b - a)},$$

yoki



$$a^{n-1} + a^{n-2}b + \dots + a^{n-k}b^k + \dots + b^{n-1} = \frac{b^n - a^n}{b - a},$$

yoki

$$b^n - a^n = (b - a)(a^{n-1} + a^{n-2}b + \dots + a^{n-k}b^{k-1} + \dots + b^{n-1}) \quad (1)$$

ayniyat hosil bo'ladi. Hisoblashlarda undan foydalanamiz.

**1 - t e o r e m a .**  $f(x)$  funksiya differensiallanadigan nuqtalarda uning  $f^n(x)$ ,  $n \in N$ , darajasi ham differensiallanadi va

$$(f^n(x))' = n f^{n-1}(x) \cdot f'(x), \quad (2)$$

$$d(f^n(x)) = n f^{n-1}(x) \cdot f' dx \quad (3)$$

munosabatlar o'rinli bo'ladi.

**I s b o t .**  $\Delta f^n(x) = f^n(x+h) - f^n(x)$  bo'lsin. (1) ayniyat bo'yicha

$$\Delta f^n(x) = (f(x+h) - f(x)) [f^{n-1}(x+h) + f(x) \cdot f^{n-2}(x+h) + \dots + f^{k-1}(x) f^{n-k}(x+h) + \dots + f^{n-1}(x)]$$

(ikkinchi qo'shiluvchi  $n$  ta qo'shiluvchidan iborat) yoki

$$\frac{\Delta f^n(x)}{h} = \frac{f(x+h) - f(x)}{h} \left[ f^{n-1}(x+h) + \dots + f^{k-1}(x) \cdot f^{n-k}(x+h) + \dots + f^{n-1}(x) \right].$$

Keyingi tenglikda  $h \rightarrow 0$  bo'lganda limitga o'tamiz. Teorema sharti bo'yicha  $f(x)$  funksiya differensiallanuvchi, demak, u uzluksiz

funksiya va shunga ko'ra  $\lim_{h \rightarrow 0} f(x+h) = f(x)$  va  $\lim_{h \rightarrow 0} \frac{f(x+h) - f(x)}{h} =$

$= f'(x)$ . Kvadrat qavslar ichidagi  $n$  ta qo'shiluvchining har birining  $h \rightarrow 0$  dagi limiti  $f^{n-1}(x)$  ga, jami yig'indi  $n f^{n-1}(x)$  ga teng. Shu tariqa (2) va (3) tengliklar hosil bo'ladi. Teorema isbotlandi.

Xususan,  $f(x) = x^n$  uchun:

$$(x^n)' = n x^{n-1} \cdot x' = n x^{n-1} \cdot 1 = n x^{n-1}$$

va

$$d(x^n) = n x^{n-1} dx. \quad (4)$$

Keyinroq, (2) formula daraja ko'rsatkichning har qanday qiymatida o'rinli ekani isbotlanadi. Buning uchun daraja asosining musbat bo'lishi,  $n$  butun son bo'lganda esa asosning faqat noldan farqli bo'lishi talab qilinadi.

**1 - m i s o l .**  $n = 1; 0; -m$  (bunda  $m \in N$ ) va  $x \neq 0$  uchun  $f(x) = x^n$  funksiya hosilasini topamiz.

Yechish. 1)  $n = 1$  da  $(x)' = 1 \cdot x^{1-1} = 1 \cdot x^0 = 1 \cdot 1 = 1$ , ya'ni  $x' = 1$ ;

2)  $n = 0$  da  $(x^0)' = 0 \cdot x^{0-1} = 0$ , ya'ni  $(x^0)' = 0$ ;

3)  $n = -m$ ,  $m \in \mathbb{N}$  da  $(x^{-m})' = -m x^{-m-1} = -m x^{-(m+1)}$ .

2-misol.  $(6x^2 - 5x + 7)^3$  funksiyaning hosilasi va differensialini topamiz.

Yechish. Bizda  $f(x) = 6x^2 - 5x + 7$ ,  $f'(x) = 12x - 5$ ,  $n = 3$ . (2) va (3) formulalar bo'yicha:

$$((6x^2 - 5x + 7)^3)' = 3(6x^2 - 5x + 7)^2 \cdot (12x - 5)$$

va

$$d(6x^2 - 5x + 7)^3 = 3(6x^2 - 5x + 7)^2 \cdot (12x - 5)dx.$$

3-misol.  $\sqrt[5]{x^4}$ ,  $x > 0$  funksiya hosilasini topamiz.

Yechish.  $\sqrt[5]{x^4}$  ifodani  $x^{\frac{4}{5}}$  ko'rinishda yozamiz. Daraja ko'rsatkichi natural son emas, lekin asos musbat son. (2) formuladan foydalanamiz:

$$\left(\sqrt[5]{x^4}\right)' = \left(x^{\frac{4}{5}}\right)' = \frac{4}{5} x^{\frac{4}{5}-1} = \frac{4}{5} x^{-\frac{1}{5}} = \frac{4}{5\sqrt[5]{x}}.$$

4-misol.  $\frac{1}{(3x^2-4)^2}$  funksiyaning hosilasini topamiz.

Yechish.  $\frac{1}{(3x^2-4)^2} = (3x^2-4)^{-2}$ ,  $f(x) = 3x^2-4$ ,  $f'(x) = 6x$ ,  $n = -2$ ,

$$\left(\frac{1}{(3x^2-4)^2}\right)' = ((3x^2-4)^{-2})' = -2 \cdot (3x^2-4)^{-2-1} \cdot 6x = -\frac{12x}{(3x^2-4)^3}.$$

5-misol.  $\sqrt{x^2+9}$  funksiya hosilasini topamiz.

Yechish.  $f(x) = x^2 + 9$ ,  $f'(x) = 2x$ ,  $n = \frac{1}{2}$ ;

$$(\sqrt{x^2+9})' = ((x^2+9)^{\frac{1}{2}})' = \frac{1}{2} \cdot (x^2+9)^{\frac{1}{2}-1} \cdot 2x = \frac{x}{\sqrt{x^2+9}}.$$

2-teorema.  $f$  va  $g$  funksiyalar differensiallanadigan  $x$  nuqtada ularning  $fg$  ko'paytmasi ham differensiallanadi va bu ko'paytmaning hosilasi va differensial

$$(fg)' = f'g + fg', \quad (4)$$

$$d(fg) = f dg + g df \quad (5)$$

formulalar bo'yicha hisoblanadi, bunda  $f = f(x)$ ,  $g = g(x)$ .

Isbot.  $\Delta(fg) = f(x + \Delta x) \cdot g(x + \Delta x) - f(x)g(x)$  yoki  $f(x + \Delta x) = f(x) + \Delta f(x)$ ,  $g(x + \Delta x) = g(x) + \Delta g(x)$  bo'lgani uchun,

$$\begin{aligned}\Delta(fg) &= (f + \Delta f)(g + \Delta g) - fg = fg + f \cdot \Delta g + g \cdot \Delta f + \Delta f \cdot \Delta g - fg = \\ &= f \cdot \Delta g + g \cdot \Delta f + \Delta f \cdot \Delta g.\end{aligned}$$

Shartga ko'ra  $f$  va  $g$  funksiyalar  $x$  nuqtada differensiallanuvchi bo'lganidan

$$\lim_{\Delta x \rightarrow 0} \frac{\Delta f}{\Delta x} = f', \quad \lim_{\Delta x \rightarrow 0} \frac{\Delta g}{\Delta x} = g',$$

$$\lim_{\Delta x \rightarrow 0} \Delta g = \lim_{\Delta x \rightarrow 0} \left( \frac{\Delta g}{\Delta x} \cdot \Delta x \right) = \lim_{\Delta x \rightarrow 0} \frac{\Delta g}{\Delta x} \cdot \lim_{\Delta x \rightarrow 0} \Delta x = g' \cdot 0 = 0.$$

U holda:

$$\begin{aligned}(fg)' &= \lim_{\Delta x \rightarrow 0} \frac{\Delta(fg)}{\Delta x} = \lim_{\Delta x \rightarrow 0} \left( f \cdot \frac{\Delta g}{\Delta x} + g \cdot \frac{\Delta f}{\Delta x} + \frac{\Delta f}{\Delta x} \cdot \Delta g \right) = f \cdot \lim_{\Delta x \rightarrow 0} \frac{\Delta g}{\Delta x} + \\ &+ g \cdot \lim_{\Delta x \rightarrow 0} \frac{\Delta f}{\Delta x} + \lim_{\Delta x \rightarrow 0} \frac{\Delta f}{\Delta x} \cdot \lim_{\Delta x \rightarrow 0} \Delta g = fg' + gf' + f' \cdot 0 = fg' + gf'.\end{aligned}$$

Shu kabi  $g' = \frac{dg}{dx}$ ,  $f' = \frac{df}{dx}$ ,  $(fg)' = \frac{d(fg)}{dx}$  bo'lganidan  $d(fg) = fg'dx + gdf$  bo'ladi.

6 - misol.  $f(x) = (x^3 + 6x - 3)(x^2 + 4x + 5)$  funksiya differensialini topamiz.

Yechish. (4) va (5) formulalar bo'yicha:

$$\begin{aligned}f'(x) &= (x^3 + 6x - 3)'(x^2 + 4x + 5) + (x^3 + 6x - 3)(x^2 + 4x + 5)' = \\ &= (3x^2 + 6)(x^2 + 4x + 5) + (x^3 + 6x - 3)(2x + 4) = 5x^4 + 16x^3 + 33x^2 + \\ &+ 42x + 18,\end{aligned}$$

$$df = (5x^4 + 16x^3 + 33x^2 + 42x + 18)dx.$$



## Mashqlar

5.43. Funksiyalarning hosilalari va differensiallarini toping:

1)  $(x^3 - 5x + 1)(x^2 - 5x + 1)$ ;

2)  $(x^4 - 6x + 1)(x^3 + x^2 - 2)$ ;

3)  $(\sqrt{x} - 1)(\sqrt[3]{x} + 4)$ ;

4)  $\sqrt{x}(x^3 - 2x + 2)$ ;

5)  $(x^2 - 4x + 2)^3$ ;

6)  $(8x - 3)^{12}$ ;

7)  $\left(\sqrt{x} + \frac{3}{x}\right)^{14}$ .

5.44.  $(uvw)'$  hosila uchun formula chiqaring.

5.45.  $y = \sqrt[3]{x} - 1$  egri chiziqning qaysi nuqtasida unga o'tkazilgan urinma absissalar o'qi bilan 45° li burchak tashkil etadi?

5.46.  $y = x^3 + x - 7$  chiziqning qaysi nuqtalarida unga o'tkazilgan urinma  $y = 13x - 4$  to'g'ri chiziqqa parallel bo'ladi?

5.47.  $f(x) = \frac{1}{3}x^3 - 2x + 1$  funksiyaning  $f(a+h)$  qiymatlarini taqribiy hisoblash uchun formula tuzing, uning yordamida quyidagi ma'lumotlar bo'yicha hisoblashlarni bajaring va hisoblash xatoligini baholang:

- 1)  $a = 3, h = 0,01$ ;                      2)  $a = 4, h = 0,1$ .

### 3. Kasrni differensiallash.

1 - t e o r e m a .  $f(x)$  funksiya differensiallanadigan va noldan farqli bo'lgan nuqtalarda  $\frac{1}{f(x)}$  funksiya ham differensiallanadi va ushbu tenglik o'rinli bo'ladi:

$$\left(\frac{1}{f(x)}\right)' = \frac{f'(x)}{f^2(x)}. \quad (1)$$

I s b o t . Oldin  $\frac{1}{f(x)}$  funksiyaning orttirmasini topamiz:

$$\Delta\left(\frac{1}{f(x)}\right) = \frac{1}{f(x+h)} - \frac{1}{f(x)} = -\frac{f(x+h) - f(x)}{f(x+h)f(x)}.$$

Endi  $\Delta\left(\frac{1}{f(x)}\right)$  orttirmalar nisbatining  $h = \Delta x \rightarrow 0$  dagi limitiga o'tamiz:

$$\begin{aligned} \left(\frac{1}{f(x)}\right)' &= -\lim_{h \rightarrow 0} \frac{f(x+h) - f(x)}{h} \cdot \lim_{h \rightarrow 0} \frac{1}{f(x+h)f(x)} = -f'(x) \cdot \frac{1}{f^2(x)} = \\ &= -\frac{f'(x)}{f^2(x)}. \end{aligned}$$

Teorema isbot qilindi.

2 - t e o r e m a .  $f$  va  $g$  funksiyalar differensiallanadigan va  $g \neq 0$  bo'lgan nuqtalarda  $\frac{f}{g}$  funksiya ham differensiallanadi va ular uchun ushbu tenglik o'rinli bo'ladi:

$$\left(\frac{f}{g}\right)' = \frac{gf' - fg'}{g^2}. \quad (2)$$

Isbot.  $\frac{f}{g}$  funksiyaning differensiallanishi uning  $f$  va  $\frac{1}{g}$  funksiyalar ko'paytmasidan iboratligidan kelib chiqadi. (1) formuladan foydalanamiz:

$$\left(\frac{f}{g}\right)' = \left(f \cdot \frac{1}{g}\right)' = f' \cdot \frac{1}{g} + f \cdot \left(\frac{1}{g}\right)' = \frac{f'}{g} - \frac{fg'}{g^2} = \frac{gf' - fg'}{g^2}.$$

1 - misol.  $\frac{x^3-5}{x^4+3}$  funksiyaning hosilasini topamiz.

Yechish. Bizda  $f = x^3 - 5$ ,  $g = x^4 + 3$ ,  $f' = 3x^2$ ,  $g' = 4x^3$  va (2) formula bo'yicha:

$$\left(\frac{x^3-5}{x^4+3}\right)' = \frac{(x^4+3) \cdot 3x^2 - (x^3-5) \cdot 4x^3}{(x^4+3)^2} = \frac{-x^6+20x^3+9x^2}{(x^4+3)^2}.$$



### Mashqlar

5.48. Funksiyalarning hosilasini toping:

- 1)  $\frac{x^2+4x}{x^3+5}$ ;      2)  $\frac{x^3}{(x-5)^4}$ ;      3)  $\frac{\sqrt{x-4}}{\sqrt[3]{x+5}}$ ;  
 4)  $\frac{(1+x^3)^{10}}{x^5}$ ;      5)  $\frac{4x^3+3x^2-5x+1}{4x-1}$ .

5.49. Hosilalarning ko'rsatilgan nuqtalardagi qiymatlarini toping:

- 1)  $f(x) = \frac{2+x^2}{\sqrt{2x}}$ ,  $f'(0)$ ,  $f'(2)$ ;  
 2)  $f(x) = \frac{x^2-5x-7}{x^3}$ ,  $f'(-1)$ ,  $f'(0,2)$ .

5.50. Absissasi 2 ga teng bo'lgan nuqtada  $y = \frac{4x-5}{\sqrt[3]{x+5}}$  funksiya grafigiga urinuvchi to'g'ri chiziqning tenglamasini tuzing.

4. Trigonometrik funksiyalarni differensiallash.

1)  $f(x) = \sin x$  funksiya hosilasini topamiz:

$$\Delta f(x) = \sin(x+h) - \sin x = 2 \cos\left(x + \frac{h}{2}\right) \sin \frac{h}{2},$$

$$\frac{\sin(x+h) - \sin x}{h} = 2 \cos\left(x + \frac{h}{2}\right) \frac{\sin \frac{h}{2}}{\frac{h}{2}},$$

lekin kosinus uzluksiz funksiya, shunga ko'ra  $\lim_{h \rightarrow 0} \cos\left(x + \frac{h}{2}\right) = \cos x$ .

Ikkinchi tomondan,  $\lim_{h \rightarrow 0} \frac{\sin \frac{h}{2}}{\frac{h}{2}} = 1$  bo'lishi oldingi boblarda isbot

qilingan edi. Shunday qilib,

$$(\sin x)' = \lim_{h \rightarrow 0} \frac{\sin(x+h) - \sin x}{h} = \cos x$$

yoki

$$(\sin x)' = \cos x \quad (1)$$

va sinus funksiya differensial:

$$d(\sin x) = \cos x dx \quad (2)$$

2)  $\cos(x+h) - \cos x = -2 \sin\left(x + \frac{h}{2}\right) \sin \frac{h}{2}$  orttirmaning  $h$  ga nisbatining  $h \rightarrow 0$  dagi limiti yuqoridagi kabi almashtirishlardan so'ng quyidagini beradi:

$$(\cos x)' = -\sin x, \quad (3)$$

$$d(\cos x) = -\sin x dx \quad (4)$$

3) bo'linma, sinus va kosinusning hosilalari formulalaridan foydalansak, quyidagilarni hosil qilamiz:

$$\begin{aligned} (\operatorname{tg} x)' &= \left(\frac{\sin x}{\cos x}\right)' = \frac{\cos x \cdot (\sin x)' - \sin x \cdot (\cos x)'}{\cos^2 x} = \\ &= \frac{\cos x \cdot \cos x - \sin x \cdot (-\sin x)}{\cos^2 x} = \frac{1}{\cos^2 x}, \end{aligned}$$

yoki

$$(\operatorname{tg} x)' = \frac{1}{\cos^2 x}, \quad (5)$$

$$d(\operatorname{tg} x) = \frac{dx}{\cos^2 x}. \quad (6)$$

4) Shu kabi:

$$(\operatorname{ctg} x)' = -\frac{1}{\sin^2 x}, \quad (7)$$

$$d(\operatorname{ctg} x) = -\frac{dx}{\sin^2 x}. \quad (8)$$

1 - misol. Sinusoida va tangensoida koordinatalar boshida  $OX$  o'qini qanday burchak ostida kesishini aniqlaymiz.

**Yechish.**  $O(0; 0)$  nuqtada sinusoidaga urinuvchi  $y = kx$  to'g'ri chiziqning  $k = \operatorname{tg}\alpha$  burchak koeffitsiyentini topishimiz kerak, bunda  $\alpha$  - izlanayotgan burchak.  $k = (\sin x)' = \cos x$ . Lekin  $O(0; 0)$  nuqtada  $\cos 0 = 1$ . Demak,  $k = \operatorname{tg}\alpha = 1$ , bundan  $\alpha = \pi/4$ .

Shu kabi  $k = (\operatorname{tg} x)' = \frac{1}{\cos^2 x}$  bo'yicha  $x = 0$  da  $k = 1$ , bu safar ham bundan  $\alpha = \pi/4$  bo'lishi aniqlanadi.

2 - misol. Absissasi  $x_0 = \frac{\pi}{6}$  bo'lgan nuqtada kosinusoidaga urinuvchi to'g'ri chiziq tenglamasini tuzamiz.

**Yechish.** Urinmaning  $y - y_0 = k(x - x_0)$  tenglamasiga  $y_0 = \cos \frac{\pi}{6} = \frac{\sqrt{3}}{2}$ ,  $k = (\cos x_0)' = -\sin x_0 = -\frac{1}{2}$  qo'yilsa,  $y - \frac{\sqrt{3}}{2} = -\frac{1}{2}(x - \frac{\pi}{6})$  hosil bo'ladi. Bu yerdan  $y = -\frac{1}{2}x + \frac{\pi}{12} + \frac{\sqrt{3}}{2}$ .

3 - misol.  $\operatorname{ctg}(\frac{\pi}{4} + 0,001)$  ning taqribiy qiymatini topamiz.

**Yechish.**  $f(x_0 + h) \approx f(x_0) + f'(x_0) \cdot h$  formuladan foydalanamiz. Bizda  $f(x) = \operatorname{ctg} x$ ,  $f'(x) = -\frac{1}{\sin^2 x}$ ,  $x_0 = \frac{\pi}{4}$ ,  $h = 0,001$ . Misolda izlanayotgan qiymatning qanday aniqlikda bo'lishi aytilmagan. Bu aniqlik 0,001 gacha kattalikda bo'lsin, deylik. U holda

$$\operatorname{ctg}\left(\frac{\pi}{4} + 0,001\right) \approx \operatorname{ctg} \frac{\pi}{4} - \frac{1}{\sin^2 \frac{\pi}{4}} \cdot 0,001 = 1 - \frac{0,001}{\left(\frac{\sqrt{2}}{2}\right)^2} = 0,998.$$

Agar burchak graduslarda berilgan bo'lsa, formulalardan foydalanishda radian o'lchoviga o'tiladi. Masalan,

$$\begin{aligned} \cos 28^\circ &= \cos(30^\circ - 2^\circ) = \cos\left(\frac{\pi}{6} - \frac{\pi}{90}\right) \approx \cos \frac{\pi}{6} - \sin \frac{\pi}{6} \cdot \left(-\frac{\pi}{90}\right) = \\ &= \frac{\sqrt{3}}{2} + \frac{1}{2} \cdot \frac{\pi}{90} = 0,8660 + 0,5 \cdot 0,0349 \approx 0,883. \end{aligned}$$

Shu maqsadda tayyor jadvallardan yoki mikrokalkulator va EHMning imkoniyatidan ham foydalanish mumkin.

**5. Murakkab funksiya hosilasi.** Oldingi bandlarda funksiyalarni differensiallash jarayonida biz hosilaning ta'rifidan foydalandik. Agar murakkab funksiyalarni differensiallash zarur bo'lsa, maxsus qoidalardan foydalanish qulayroq.

**Teorema.**  $f(x)$  funksiya  $x$  nuqtada,  $g(t)$  funksiya  $t = f(x)$  nuqtada differensiallansin. U holda  $g(f(x))$  murakkab funksiya ham  $x$  nuqtada differensiallanadi va ushbu tenglik o'rinli bo'ladi:

$$(g(f(x)))' = g'(f(x)) \cdot f'(x). \quad (1)$$

**Isbot.**  $t = f(x)$ ,  $t + v = f(x + h)$  bo'lsin.  $g(t)$  funksiya orttirmasi:  $\Delta(g(f(x))) = g(f(x + h)) - g(f(x)) = g(t + v) - g(t)$ . Shart bo'yicha  $g$  funksiya  $t = f(x)$  nuqtada differensiallanadi. Shunga ko'ra:

$$\Delta(g(f(x))) = (g'(t) + \alpha)v = (g'(t) + \alpha)(f(x + h) - f(x)), \quad (2)$$

bunda  $\alpha$  miqdor  $v \rightarrow 0$  da cheksiz kichrayadi. Biz  $v = 0$  da  $\alpha = 0$  deb qabul qilamiz. (2) tenglikning ikkala qismini  $h$  ga bo'lib,  $h \rightarrow 0$  bo'yicha limitga o'tamiz. U holda  $v \rightarrow 0$  bo'lganidan  $\alpha \rightarrow 0$  bo'ladi. Natijada:

$$\begin{aligned} \lim_{h \rightarrow 0} \frac{\Delta g(f(x))}{h} &= \lim_{h \rightarrow 0} (g'(t) + \alpha) \cdot \lim_{h \rightarrow 0} \frac{\Delta f}{h} = g'(t) \cdot f'(x) = \\ &= g'(f(x)) \cdot f'(x). \end{aligned}$$

Isbot bo'ldi.

1 - misol. Agar  $g(t) = t^n$ ,  $t = f(x)$  bo'lsa,  $g'(t) = (t^n)' = nt^{n-1}$ .  $t' = n(f(x))^{n-1} \cdot f'(x)$  bo'ladi.

2 - misol.  $\cos(x^3 - x^2 - 2)$  funksiyaning hosilasini topamiz.

**Yechish.**  $t = x^3 - x^2 - 2$ ,  $g(t) = \cos t$  bo'lsin. U holda:  $g'(t) = -\sin t$ ,  $f'(x) = 3x^2 - 2x$ . U holda:  $(\cos(x^3 - x^2 - 2))' = -\sin(x^3 - x^2 - 2) \cdot (3x^2 - 2x)$ .



## Mashqlar

**5.51.** Hosilalari va differensiallarini toping:

- |                                      |                                      |   |
|--------------------------------------|--------------------------------------|---|
| 1) $\cos^4 x$ ;                      | 2) $\frac{1}{\cos x}$ ;              | 3) $\operatorname{tg} x + \operatorname{ctg} x$ ; |
| 4) $\sin^3 x - \cos^3 x$ ;           | 5) $\frac{1}{\cos^3 x}$ ;            | 6) $(x^3 - 4)\cos^2 x$ ;                          |
| 7) $3x^2 \cos x + (x^3 + 5)\sin x$ ; | 8) $\frac{1 + \cos x}{1 - \cos x}$ ; |   |



9)  $\frac{1+\sin x}{1-\sin x}$ ;

10)  $6 \sin^3 x + 4 \operatorname{tg}^5 x$ .

**5.52.** Hosilaning ta'rifidan foydalanib isbot qiling:

1)  $(\operatorname{tg} 2x)' = \frac{2}{\cos^2 2x}$ ;

2)  $(\operatorname{ctgx})' = -\frac{1}{\sin^2 x}$ ;

3)  $(\cos 2x)' = -2 \sin 2x$ ;

4)  $(\sin 3x)' = 3 \cos 3x$ .

**5.53.** Ifodalarning taqribiy qiymatlarini toping:

1)  $\sin\left(\frac{\pi}{6} + 0,02\right)$ ;

2)  $\cos\left(\frac{\pi}{3} + 0,001\right)$ ;

3)  $\operatorname{tg}\left(\frac{\pi}{3} + 0,001\right)$ ;

4)  $\operatorname{tg}\left(\frac{3\pi}{4} - 0,02\right)$ ;

5)  $\operatorname{ctg}\left(\frac{2\pi}{3} - 0,003\right)$ ;

6)  $\sin 74^\circ$ ;

7)  $\cos 31^\circ 30'$ ;

8)  $\operatorname{ctg} 59^\circ 30'$ .

**5.54.**  $x_0$  nuqtada  $f$  funksiya grafigiga urinuvchi to'g'ri chiziq tenglamasini tuzing:

1)  $f(x) = \sin^3 x$ ,  $x_0 = \frac{2\pi}{3}$ ;

2)  $f(x) = x \cos x$ ,  $x_0 = \frac{2\pi}{3}$ ;

3)  $f(x) = \operatorname{tg}^3 x$ ,  $x_0 = \frac{\pi}{3}$ ;

4)  $f(x) = \sqrt[3]{\operatorname{ctgx}}$ ,  $x_0 = \frac{5\pi}{4}$ .

**5.55.** Funksiyaning hosilasini toping:

1)  $(5x-1)^{16}$ ;

2)  $\sin\left(5x + \frac{\pi}{3}\right)$ ;

3)  $\sin^3\left(7x^2 - \frac{\pi}{6}\right)$ ;

4)  $3x^2 - \frac{1}{\sin^2 3x}$ ;

5)  $4 \sin^2 x - 1$ ;

6)  $\cos \sqrt{x}$ ;

7)  $\sqrt{\sin 2x}$ ;

8)  $\sqrt{\cos^3 7x + \sin^3 7x}$ ;

9)  $\sqrt{\operatorname{tg} x} - \sqrt[3]{\operatorname{ctg} x}$ ;

10)  $y = \sin \frac{1}{x}$ ;

11)  $y = \sin(\sin x)$ ;

12)  $y = \sqrt{\operatorname{tg} \frac{x}{2}}$ ;

13)  $y = \sin \sqrt{1+x^2}$ ;

14)  $y = \sqrt{1 + \left(\operatorname{tg} x + \frac{1}{x}\right)}$ ;

15)  $y = \cos^2 \frac{1-\sqrt{x}}{1+\sqrt{x}}$ .

**5.56.**  $x_0$  nuqtada  $f$  funksiya grafigiga urinuvchi to'g'ri chiziqning tenglamasini tuzing:

1)  $f(x) = \cos x$ ,  $x_0 = \sqrt[3]{\frac{\pi}{6}}$ ;    2)  $f(x) = \sin(x^2 - 3x + 1)$ ,  $x_0 = \frac{\pi}{3}$ ;

3)  $f(x) = \operatorname{tg}(\sqrt[3]{x})$ ,  $x_0 = \pi^3$ ;    4)  $f(x) = \operatorname{ctg}(x^4 - \frac{\pi}{6})$ ,  $x_0 = \frac{\pi}{4}$ .

**5.57.**  $f(a + h) \approx f(a) + f'(a) \cdot h$  formuladan foydalanib, funksiyalarning qiymatini 0,001 gacha aniqlikda toping:

1)  $\sin(\frac{\pi}{3} - 0,003)$ ;    2)  $\cos(\frac{\pi}{6} + 0,002)$ ;    3)  $\operatorname{tg}(\frac{\pi}{4} + 0,003)$ ;

4)  $\sin 61^\circ$ ;    5)  $\cos 30^\circ 30'$ ;    6)  $\operatorname{tg} 59^\circ 30'$ .

**5.58.** Quyidagi funksiyalarni tekshiring va grafigini yasang:

1)  $f(x) = \sin x + \frac{1}{3} \sin 3x + \frac{1}{5} \sin 5x$ ;

2)  $f(x) = \cos x + \frac{1}{3} \cos 3x + \frac{1}{5} \cos 5x$ .

**5.59.** Tekislikda olingan  $O$  va  $A$  nuqtalar orasidagi masofa  $s$  ga teng.  $A$  nuqtadagi  $E$  yoritilganlik eng katta bo'lishi uchun  $B$  lampochka shu tekislikdan qanday balandlikda ilinishi kerak?

( $OB = ?$ )  $A$  nuqtadagi yoritilganlik  $E = I \cdot \frac{\sin \varphi}{r^2}$  formula bo'yicha hisoblanadi, bunda  $r = AB$ ,  $\varphi = \angle BAO$ ; argument sifatida  $\varphi$  burchakni oling;  $I$  – yorug'lik kuchi (V.3-rasm).

## 6. Teskari trigonometrik funksiyalarni differensiallash.

Agar  $y = \varphi(x)$  va  $y = \psi(x)$  funksiyalar o'zaro teskari bo'lsa, ularning grafiglari  $u = x$  bissektrisaga nisbatan simmetrik joyla-

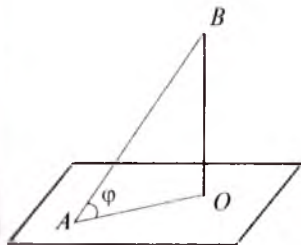

V.3-rasm.

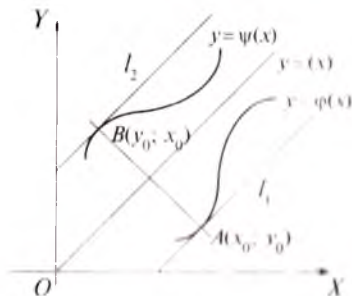

V.4-rasm.

shishini bilamiz. Shunga ko'ra, biror  $A(x_0; y_0)$  nuqtada  $\varphi$  grafikka urinuvchi  $l_1$  to'g'ri chiziqqa  $y = x$  to'g'ri chiziqqa nisbatan simmetrik  $B(y_0; x_0)$  nuqtada  $\psi$  grafikka urinuvchi  $l_2$  to'g'ri chiziq mavjud (V.4-rasm).

Demak,  $x_0$  nuqtada  $\varphi$  funksiyaning differensiallanishidan  $y_0$  nuqtada  $\psi$  funksiyaning differensiallanishi kelib chiqadi (qat'iy isboti oliy matematikada beriladi). Xususan, trigonometrik funksiyalarning differensiallanishidan teskari trigonometrik funksiyalarning differensiallanishi kelib chiqadi. Bundan foydalanamiz:

1) Agar  $y = \arcsin x$  bo'lsa,  $\sin y = x$  bo'lishini bilamiz, bunda  $-\frac{\pi}{2} < y < \frac{\pi}{2}$ . U holda  $(\sin y)' = x' = 1$  yoki murakkab funksiya hosilasi formulasi bo'yicha  $\cos y \cdot y' = 1$  yoki  $y' = \frac{1}{\cos y}$  ga ega bo'lamiz. Lekin  $-\frac{\pi}{2} < y < \frac{\pi}{2}$  da  $\cos y > 0$ ,  $\cos y = \sqrt{1 - \sin^2 y} = \sqrt{1 - x^2}$ , natijada:

$$(\arcsin x)' = \frac{1}{\sqrt{1-x^2}}, \quad (x < 1), \quad (1)$$

$$d(\arcsin x) = \frac{dx}{\sqrt{1-x^2}}, \quad |x| < 1. \quad (2)$$

2) Shu kabi quyidagilarni hosil qilamiz (unda  $|x| < 1$ ):

$$(\arccos x)' = -\frac{1}{\sqrt{1-x^2}}, \quad (3)$$

$$d(\arccos x) = -\frac{dx}{\sqrt{1-x^2}}. \quad (4)$$

3)  $y = \arctg x$  bo'yicha  $tgy = x$ , lekin  $(tgy)' = \frac{1}{\cos^2 y} \cdot y' = 1$  edi.

Bu tenglikka  $\cos^2 y = \frac{1}{1+tg^2 y} = \frac{1}{1+x^2}$  qo'yilsa, natijada:

$$(\arctg x)' = \frac{1}{1+x^2}, \quad (5)$$

$$d(\arctg x) = \frac{dx}{1+x^2}. \quad (6)$$

4) Shu kabi:

$$(\text{arcctg } x)' = -\frac{1}{1+x^2}, \quad (7)$$

$$d(\operatorname{arctg}x) = -\frac{dx}{1+x^2}. \quad (8)$$

1 - m i s o l . Quyidagi funksiyalarning hosilalarini topamiz:

a)  $2x \cdot \operatorname{arctg}^2 4x$ ;    b)  $x^3 \cdot \operatorname{arcsin} 3x$ ;    d)  $\frac{2}{\operatorname{arcsin} 2x}$ .

Y e c h i s h .

$$\begin{aligned} \text{a) } (2x \cdot \operatorname{arctg}^2 4x)' &= 2x' \cdot \operatorname{arctg}^2 4x + 2x \cdot (\operatorname{arctg}^2 4x)' = \\ &= 2(\operatorname{arctg}^2 4x + x \cdot 2\operatorname{arctg} 4x \cdot \frac{1}{1+16x^2} \cdot (4x)') = 2\operatorname{arctg} 4x \cdot (\operatorname{arctg} 4x + \\ &+ \frac{8x}{1+16x^2}); \end{aligned}$$

$$\begin{aligned} \text{b) } (x^3 \cdot \operatorname{arcsin} 3x)' &= (x^3)' \operatorname{arcsin} 3x + x^3 (\operatorname{arcsin} 3x)' = \\ &= 3x^2 \cdot \operatorname{arcsin} 3x + x^3 \cdot \frac{1}{\sqrt{1-9x^2}} \cdot (3x)' = 3x^2 \left( \operatorname{arcsin} 3x + \frac{x}{\sqrt{1-9x^2}} \right); \end{aligned}$$

$$\begin{aligned} \text{d) } \left( \frac{2}{\operatorname{arcsin} 2x} \right)' &= 2((\operatorname{arcsin} 2x)^{-1})' = -2 \cdot \frac{1}{\operatorname{arcsin}^2 2x} \cdot (\operatorname{arcsin} 2x)' = \\ &= -\frac{2}{\operatorname{arcsin}^2 2x} \cdot \frac{1}{\sqrt{1-(2x)^2}} \cdot (2x)' = -\frac{4}{\operatorname{arcsin}^2 2x \cdot \sqrt{1-4x^2}}. \end{aligned}$$

2 - m i s o l .  $x_0 = \frac{1}{3}$  nuqtada  $y = \operatorname{arctg} 3x$  funksiya grafigiga uri-nuvchi to'g'ri chiziq tenglamasini tuzamiz.

Y e c h i s h . Tenglamani  $y = y_0 + k(x - x_0)$  ko'rinishda izlaymiz.

Masala shartiga ko'ra  $x_0 = \frac{1}{3}$ ,  $y_0 = \operatorname{arctg} \left( 3 \cdot \frac{1}{3} \right) = \operatorname{arctg} 1 = \frac{\pi}{4}$ ,

$$k = y' = (\operatorname{arctg} 3x)' = -\frac{3}{1+9x^2}, \quad y'(x_0) = -\frac{3}{1+9 \cdot \left(\frac{1}{3}\right)^2} = -\frac{3}{2}. \text{ Urinma:}$$

$$y = \frac{\pi}{4} - \frac{3}{2} \left( x - \frac{1}{3} \right).$$

3 - m i s o l . a)  $\operatorname{arcsin} 0,48$ ; b)  $\operatorname{arctg} 0,96$  ifodalar qiymatlarini 0,001 gacha aniqlikda topamiz.

Y e c h i s h . a)  $f(x+h) \approx f(x) + f'(x)h$  taqribiy formuladan foydalanamiz. Bizda

$$\begin{aligned} \arcsin 0,48 &= \arcsin(0,5 - 0,02) \approx \arcsin 0,5 + \frac{1}{\sqrt{1-0,5^2}} \cdot (-0,02) = \\ &= \frac{\pi}{6} - \frac{0,04}{\sqrt{3}} = 0,5236 - 0,0231 = 0,5005 \approx 0,501; \end{aligned}$$

b)  $\operatorname{arctg} 0,96 = \operatorname{arctg}(1 - 0,04) \approx \operatorname{arctg} 1 + \frac{1}{1+1^2} \cdot (-0,04) =$   
 $= \frac{\pi}{4} - 0,02 \approx 0,765$ .  $|x| < 1$  bo'lganda  $\operatorname{arctg} x$  va  $\operatorname{arcct} x$  ni aniqroq hisoblash maqsadida quyidagi taqribiy tengliklardan foydalanish mumkin:

$$\operatorname{arctg} x = x - \frac{x^3}{3} + \frac{x^5}{5} + \dots + (-1)^n \cdot \frac{x^{2n+1}}{2n+1} \pm \dots, \quad n \in N. \quad (9)$$

$$\operatorname{arcct} x = \frac{\pi}{2} - \operatorname{arctg} x. \quad (9')$$

4 - misol.  $\operatorname{arctg} 0,3$  qiymatini  $1 \cdot 10^{-4}$  gacha aniqlikda topamiz.

Yechish. Shunday natural  $n$  sonni topish kerakki, unda

$$\frac{0,3^{2n+1}}{2n+1} < 0,0001 \text{ bo'lsin. } n=2 \text{ da } \frac{0,3^5}{5} = 0,00048 > 0,0001, \text{ lekin}$$

$n=3$  da  $\frac{0,3^7}{7} = 0,00003 < 0,0001$ . Shuning uchun  $n=3$  deb olinishi kifoya. U holda:

$$\operatorname{arctg} 0,3 \approx 0,3 - \frac{0,3^3}{3} + \frac{0,3^5}{5} - \frac{0,3^7}{7} \approx 0,2958.$$



## Mashqlar

**5.60.** Funksiyalarning hosilalarini toping:

1)  $y = \arcsin^2 3x$ ;

2)  $y = \arccos^2 \sqrt{x}$ ;

3)  $y = \operatorname{arctg}^3 x^4$ ;

4)  $y = \operatorname{arcctg}(\operatorname{ctg} x)$ ;

5)  $y = \arcsin x - \arccos x$ ;

6)  $y = \arccos \frac{x}{1+x^2}$ ;

7)  $y = \frac{-x \cdot \arccos x}{\sqrt{1-x^2}}$ ;

8)  $y = \frac{\arcsin x}{\arccos x}$ ;

9)  $y = x \arcsin x + \sqrt{1-x^2}$ ;

10)  $y = x \cdot \sin x \cdot \operatorname{arctg} x$ ;

$$11) y = \sqrt{x} \cdot \arctg x ; \quad 12) y = \arcsin \frac{2}{x} ;$$

$$13) y = \arcsin \sqrt{\frac{1-x}{1+x}} .$$

**5.61.** 0,001 gacha aniqlikda hisoblang:

$$1) \arcsin(-0,47); \quad 2) \arctg(\sqrt{3}-0,003); \quad 3) \arccos 0,52 .$$

**5.62.** Funksiyalarning grafiklarini yasang:

$$1) y = \arctg \frac{1-x}{1+x}; \quad 2) y = 3x - \arctg \frac{x}{3}; \quad 3) y = x + \arctg x .$$

**7. Yuqori tartibli hosilalar.**  $f'(x)$  hosila  $x$  ning funksiyasidan iborat. Uning  $(f'(x))'$  hosilasi (albatta, u mavjud bo'lsa)  $f$  funksiyaning *ikkinchi hosilasi* yoki *ikkinchi tartibli hosilasi* deyiladi va  $f''(x)$  orqali belgilanadi. Ta'rif bo'yicha  $(f'(x))' = f''(x)$ . Shu kabi  $(f'')' = f'''$ ,  $(f''')' = f^{IV}$  va hokazo. Masalan,  $f(x) = x^3$  funksiya uchun  $f' = 3x^2$ ,  $f'' = 3 \cdot 2x$ ,  $f''' = 3 \cdot 2 \cdot 1 = 6$ ,  $f^{IV} = 6' = 0$ .

To'g'ri chiziqli harakat qilayotgan nuqta  $t$  vaqt ichida  $s$  masofani o'tgan va  $v = \frac{s}{t}$  tezlikka erishgan bo'lsin. Agar tezlik ( $t$ ;  $t + \Delta t$ ) vaqt oralig'ida  $\Delta v$  orttirma olgan bo'lsa,  $\frac{\Delta v}{\Delta t}$  nisbat tezlikning vaqt birligi ichida o'rtacha o'zgarishini ko'rsatadi va *o'rtacha tezlanish* deb ataladi.  $t$  momentdagi tezlanish sifatida  $v'(t) = \frac{dv}{dt}$  hosila qabul qilinadi. Lekin  $v$  tezlikning o'zi  $s'(t) = \frac{ds}{dt}$  birinchi tartibli hosila. Demak, tezlanish  $s$  kattalikning ikkinchi tartibli hosilasi bo'ladi:  $a = s''(t)$ . Shu kabi  $(n-1)$ - tartibli hosiladan olingan hosila funksiyaning  $n$ - *tartibli hosilasi* bo'ladi:

$$(f^{(n-1)})' = f^{(n)} .$$

Hosilaning tartibini ko'rsatuvchi  $n$  sonni daraja ko'rsatkichidan farq qilib, rim raqamlarida yoki kichik qavslar ichiga olib yoziladi:

$$y'', y''', y^{IV}, y^V, y^{(6)}, y^{(m)} \text{ va hokazo.}$$

$f(x) = x^m$ ,  $m \in N$  funksiyadan olinadigan  $n$ - tartibli hosila

$$(x^m)^{(n)} = (mx^{m-1})^{(n-1)} = (m(m-1)x^{m-2})^{(n-2)}, \text{ umuman,}$$

$$(x^m)^{(n)} = m(m-1)(m-2)\dots(m-n+1)x^{m-n}, \quad m \geq n \quad (1)$$

ko'rinishda bo'ladi.

Xususan,  $m = n$  bo'lganda  $(x^m)^{(n)} = m(m-1)(m-2) \cdot \dots \cdot 3 \cdot 2 \cdot 1 = m!$  ga ega bo'lamiz. Masalan,  $(x^4)^{IV} = 4 \cdot 3 \cdot 2 \cdot 1 = 4! = 24$ .  $m < n$  da  $(x^m)^{(n)} = 0$  bo'ladi. Haqiqatan,  $(x^4)^{(V)} = ((x^4)^{IV})' = (24)' = 0$ .

1-misol.  $(x^3 + 3)^6 \cdot (x^2 - 5)^3$  funksiyaning  $n = 24$ - tartibli hosilasini topamiz.

**Yechish.** Qavslar ochilib, ixchamlashtirishlar bajarilsa, bosh hadi  $x^{24}$  bo'lgan, ya'ni  $m = 24$ -darajali ko'phad hosil bo'ladi.  $m = n$  bo'lmoqda. Shunga ko'ra  $((x^3 + 3)^6 \cdot (x^2 - 5)^3)^{(24)} = (x^{24} + A \cdot x^{23} + B \cdot x^{22} + \dots + M)^{(24)} = ((1) \text{ formula}) 24 \cdot 23 \cdot \dots \cdot (24 - 24 + 1)x^{24-24} + 0 + 0 + \dots + 0 = 24!$ , bunda  $A, B, \dots, M$  - ixchamlashtirishlar natijasida hosil bo'ladigan sonlar.



## Mashqlar

**5.63.** Hosilalarni toping:

1)  $(x^2 + 3x - 1)''$ ;

2)  $(x^2 + 3x - 1)'''$ ;

3)  $(3x^5 - 2x^2 + 3)^{(4)}$ ;

4)  $\left(\frac{x^3+4}{x^3+6}\right)''$ ;

5)  $\left(\frac{x^3}{x^2-1}\right)''$ ;

6)  $\left(\frac{\sqrt{x}}{x^2+1}\right)''$ ;

7)  $\left(\sqrt{\frac{x}{2}}\right)''$ ;

8)  $((x^2 - 4)^5 \cdot (x^3 + 1)^{10})^{(45)}$ ;

9)  $((x^2 - 4)^5 \cdot (x^3 + 1)^{10})^{(40)}$ ;

10)  $(x^4 - 2x^3)^{(7)}$ ;

11)  $\left(\frac{1}{x^2+9x+20}\right)^{(48)}$ .

**5.64.**  $\left(\frac{a}{x+a}\right)^{(n)}$  uchun formula chiqaring.

**5.65.** So'nmas tebranma harakat  $s = A \sin \frac{2\pi t}{T}$  tenglama bilan ifodalanadi, bunda  $T$  - tebranish davri,  $A$  - amplitudasi,  $s$  - turg'unlik holatidan og'ish. Harakatning  $v = s'$  tezligi va  $v' = s''$  tezlanishini toping.

**8. Ko'rsatkichli, logarifmik va darajali funksiyalarning hosilasi.** Dastlab  $y = e^x$  funksiyaning hosilasini hisoblaymiz:

$$\Delta y = e^{x+h} - e^x = e^x (e^h - 1); \quad \frac{\Delta y}{h} = e^x \cdot \frac{e^h - 1}{h}.$$

$\lim_{h \rightarrow 0} \frac{e^h - 1}{h} = 1$  bo'lganligi uchun  $\lim_{h \rightarrow 0} \frac{\Delta y}{h} = e^x$ , ya'ni  $(e^x)' = e^x$ .

$y = e^{u(x)}$  funksiya berilgan bo'lsa, murakkab funktsiyani differensiallash qoidasiga ko'ra

$$(e^{u(x)})' = e^{u(x)} \cdot u'(x)$$

bo'ladi.

$y = a^x$  funktsiyani differensiallash uchun  $a^x = e^{x \ln a}$  munosabatdan foydalanamiz:

$$(a^x)' = (e^{x \ln a})' = e^{x \ln a} \cdot (x \cdot \ln a)' = a^x \cdot \ln a.$$

Demak,  $(a^x)' = a^x \cdot \ln a$ .

1 - misol.  $(e^{3x})' = e^{3x} \cdot (3x)' = 3e^{3x}$ .

2 - misol.  $y = 3^x$  hosilasini hisoblaymiz.

Yechish.  $y' = 3^x \cdot \ln 3$ .

Umuman,

$$(a^{u(x)})' = a^{u(x)} \cdot u'(x) \cdot \ln a.$$

3 - misol.  $(3^{\sin x})' = 3^{\sin x} \cdot \cos x \cdot \ln 3$ .

$y = \log_a x$  logarifmik funksiya  $x = a^y$  funktsiyaga nisbatan teskari funksiya bo'lgani uchun teskari funktsiyani differensiallash qoidasiga ko'ra

$$y'_x = \frac{1}{x'_y} = \frac{1}{a^y \ln a} = \frac{1}{\ln a} \cdot \frac{1}{x}$$

bo'ladi. Demak,  $(\log_a x)' = \frac{1}{x \ln a}$ . Xususan,  $(\ln x)' = \frac{1}{x}$ .

Agar  $y = \log_a u(x)$  funktsiyani differensiallash talab etilsa,

$$(\log_a u(x))' = \frac{1}{u(x) \ln a} \cdot u'(x)$$

bo'ladi.

4 - misol. a)  $y = \log_3 x$ ; b)  $y = \log_4 5x$  funktsiyalar hosillarini hisoblaymiz.

Yechish. a)  $y' = \frac{1}{x \ln 3}$ ; b)  $y' = \frac{1}{x \ln 4}$ .



Biz  $(x^n)' = nx^{n-1}$ ,  $n \in N$  ekanligini ko'rgan edik. Endi  $y = x^\alpha$ ,  $\alpha \in R$  funksiyani differensiallash qoidasini keltiramiz.  $y = x^\alpha = e^{\alpha \cdot \ln x}$  bo'lganligi uchun

$$y' = (e^{\alpha \ln x})' = e^{\alpha \ln x} (\alpha \ln x)' = x^\alpha \cdot \alpha \cdot \frac{1}{x} = \alpha x^{\alpha-1}.$$

Demak,  $(x^\alpha)' = \alpha x^{\alpha-1}$ . Funksiya murakkab bo'lgan holda,

$$(u(x))^\alpha)' = \alpha(u(x))^{\alpha-1} \cdot u'(x)$$

bo'ladi.

5-misol.  $y = 5 \cdot x^{-\frac{3}{4}}$  funksiyaning hosilasini hisoblaymiz.

Yechish.  $y' = 5 \cdot \left(-\frac{3}{4}\right) \cdot x^{-\frac{3}{4}-1} = -\frac{15}{4} x^{-\frac{7}{4}}.$



## Mashqlar

**5.66.** Funksiyalarning hosilasini toping:

- |                              |                               |                                  |
|------------------------------|-------------------------------|----------------------------------|
| 1) $y = 2^x$ ;               | 2) $y = \frac{x}{4^x}$ ;      | 3) $y = x \cdot 10^x$ ;          |
| 4) $y = e^x \cos x$ ;        | 5) $y = \frac{\cos x}{e^x}$ ; | 6) $y = \frac{1-10^x}{1+10^x}$ ; |
| 7) $y = \frac{e^x}{1+x^2}$ ; | 8) $y = \sin(2^x)$ .          |                                  |

**5.67.** Funksiyalarning hosilasini toping:

- |                                    |                           |                            |
|------------------------------------|---------------------------|----------------------------|
| 1) $y = \log_3 x$ ;                | 2) $y = \ln^2 x$ ;        | 3) $y = x \lg x$ ;         |
| 4) $y = \frac{x-1}{\log_2 x}$ ;    | 5) $y = x \sin x \ln x$ ; | 6) $y = \frac{1}{\ln x}$ ; |
| 7) $y = \frac{1-\ln x}{1+\ln x}$ ; | 8) $y = \ln \sin x$ .     |                            |

**5.68.** Funksiyalarning hosilasini toping:

- |  |                                   |   |
|--|-----------------------------------|---|
| 1) $y = \frac{(x+4)^2}{x+3}$ ;                   | 2) $y = \frac{x^2}{(1-x)^2}$ ;    | 3) $y = \frac{1+\sqrt{x}}{1+\sqrt{2x}}$ ; |
| 4) $y = \frac{1-\sqrt[3]{2x}}{1+\sqrt[3]{2x}}$ ; | 5) $y = \sqrt{1-x^2}$ ;           | 6) $y = \left(\frac{x}{1-x}\right)^m$ ;   |
| 7) $y = 3\sqrt{\frac{1}{1+x^2}}$ ;               | 8) $y = \frac{1+x}{\sqrt{1-x}}$ . |   |

### 3-§. Hosilaning tatbiqi

**1. Funksiyaning ekstremumlarini aniqlash.** Agar  $[a; b]$  kesmada  $f(x)$  funksiya o'suvchi bo'lsa (V.5-rasm) shu kesmaga tegishli ixtiyoriy  $x = x_1$  absissali nuqtada  $f(x)$  grafigiga o'tkazilgan urinma  $OX$  o'qining musbat yo'nalishi bilan  $\varphi$  o'tkir burchak tashkil etadi. O'tkir burchak tangensi esa musbat,  $\text{tg}\varphi > 0$ , bundan  $k = f'(x_1) > 0$  ni aniqlaymiz.

Shu kabi  $[d; e]$  da  $f$  funksiya kamayuvchi bo'lsa,  $\varphi$  o'tmas burchak va  $k = \text{tg}\varphi = f'(x) < 0$  bo'ladi.

$f$  funksiya o'suvchi, ya'ni  $x_1 < x_1 + h$  bo'lganda  $f(x_1) < f(x_1 + h)$  bo'lib, argumentning  $\Delta x = (x_1 + h) - x_1 = h$  orttirmasi va funksiyaning unga mos  $\Delta y = f(x_1 + h) - f(x_1)$  orttirmasi bir xil ishorali, funksiya kamayuvchi bo'lganda esa qarama-qarshi ishorali bo'ladi.

**1 - t e o r e m a .** Agar  $x_1$  nuqtada  $f$  funksiyaning hosilasi  $f'(x_1) > 0$  bo'lsa, shu nuqta yaqinida argumentning  $\Delta x = h$  va funksiyaning  $\Delta y = f(x_0 + h) - f(x_0)$  orttirmalari bir xil ishorali,  $f'(x_1) < 0$  bo'lganda bu orttirmalar qarama-qarshi ishorali bo'ladi.

**I s b o t .** Shartga ko'ra  $x_0$  nuqtada  $f'$  hosila mavjud. U holda  $x = x_0$  dan  $x = x_0 + h$  ga o'tishdagi funksiya orttirmasini

$$\Delta f = f(x_1 + h) - f(x_1) = (f'(x_1) + \alpha) \cdot h$$

ko'paytma ko'rinishida yozish mumkin.  $\alpha$  funksiya  $h \rightarrow 0$  da cheksiz kichik,  $\lim_{h \rightarrow 0} \alpha = 0$ . Shunga ko'ra  $h \rightarrow 0$  da  $f'$  va  $f' + \alpha$  lar  $x_1$  nuqta

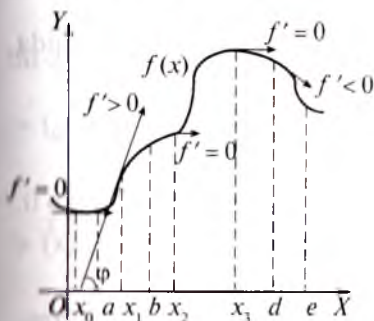

V.5-rasm.

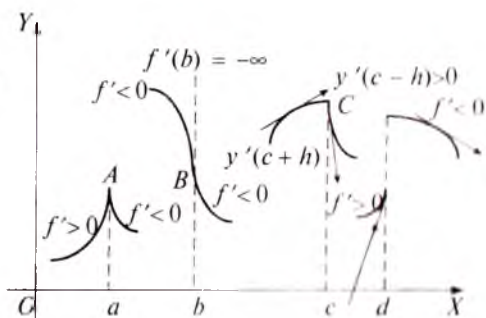

V.6-rasm.

yaqinida bir xil ishoraga ega bo'ladi. Demak, ikki hol bo'lishi mumkin:

1) yo  $f' > 0$ , u holda ko'paytmadagi  $\Delta f$  va  $h$  orttirmalar bir xil ishorali;

2) yoki  $f' < 0$ , bu holda  $\Delta f$  va  $h$  orttirmalar har xil ishorali. Isbot bo'ldi.

$x_0$  nuqtaning (V.5-rasm) chap yaqinida  $f'(x_0 - h) < 0$ , o'zida  $f'(x_0) = 0$  (chunki  $(x_1, f(x_1))$  nuqtadan o'tuvchi urinma  $OX$  o'qiga parallel,  $\varphi = 0$ ,  $\text{tg}\varphi = 0$ ), o'ng yaqinida  $f'(x_0 + h) > 0$ . Shu bilan birga  $f$  ning  $x_0$  nuqta atrofidagi qiymatlari  $x_0$  dagi qiymatidan kichik emas,  $f(x_0 + h) \geq f(x_0)$ , ya'ni  $f(x)$  funksiya  $x_0$  nuqtada *minimum*ga erishadi. Aksincha,  $f(x_3 \pm h) \leq f(x_3)$ , ya'ni funksiya  $x_3$  nuqtada *maksimum*ga erishadi. Maksimum va minimum nuqtalarini birgalikda funksiyaning *ekstremum nuqtalari* deb ataladi.

Shunday qilib, funksiyaning nuqtada ekstremumga (ekstremal qiymatga) ega bo'lishi uning shu nuqtada va uning atrofida qanday qiymat qabul qilishiga bog'liq. Ekstremum nuqtasida  $f' = 0$  bo'lib, unda  $f$  grafigiga urinma  $OX$  o'qiga parallel bo'ladi. Lekin hosila mavjud bo'lmagan (funksiya differentsiallanmaydigan) nuqtalarda ham funksiya ekstremumga ega bo'lishi mumkin. V.6-rasmda  $A$  maksimum nuqtasidan o'tgan urinma  $OY$  o'qiga parallel ( $\varphi = 90^\circ$ ),  $f'(x = a) = \text{tg}90^\circ = \infty$ . Chizmadagi  $C$  maksimum nuqtasidan esa bittadan ortiq (chizmada ikkita) urinma o'tayotganligidan bu holda ham hosila mavjud emas.

**2 - t e o r e m a .**  $f$  funksiyaning hosilasi  $x_0$  ekstremum nuqtada yo nolga teng, yoki mavjud emas.

Isbot. To'rt hol bo'lishi mumkin: 1)  $f'(x_0) > 0$ ; 2)  $f'(x_0) < 0$ ; 3)  $f'(x_0) = 0$ ; 4)  $f'(x_0)$  hosila mavjud emas.

Agar  $f'(x_0) > 0$  bo'lsa, 1-teoremaga muvofiq  $x_0$  nuqta yaqinida  $\Delta f$  va  $\Delta x$  orttirmalar bir xil ishoraga ega bo'ladi:

$[x_0 - h; x_0]$  kesmada  $\Delta x = x_0 - (x_0 - h) = h > 0$  va  $\Delta f = f(x_0) - f(x_0 - h) > 0$ ;

$[x_0; x_0 + h]$  da  $\Delta x = (x_0 + h) - x_0 = h > 0$ ,  $\Delta f = f(x_0 + h) - f(x_0) > 0$ .

Bunga qaraganda  $[x_0 - h; x_0 + h]$  kesmada  $f(x_0 - h) < f(x) < f(x_0 + h)$  o'rinli, ya'ni  $x_0$  - ekstremum nuqtasi emas.

Shu kabi, agar  $f'(x_0) < 0$  bo'lsa,  $f$  funksiya  $x_0$  nuqtada ekstremumga ega bo'lmashligi isbotlanadi. Demak,  $f'(x) = 0$  bo'ladigan

yoki  $f'(x)$  mavjud bo'lmagan nuqtalar ekstremum nuqtalari bo'lishi mumkin.

Bu teorema ekstremumlikka «shubhali» nuqtalarni aniqlashga imkon beradi. Ular orasidan haqiqatan ham ekstremum nuqtalari ajratib olinishi kerak. Masalan,  $f(x) = (x - 2)^3$  funksiyaning hosilasi  $f'(x) = 3(x - 2)^2$  va o'zi  $x = 2$  da nolga aylanadi. Lekin bu nuqta ekstremum nuqtasi emas. Chunki  $x = 2$  dan chapda  $(x - 2)^3$  funksiya manfiy, o'ngda musbat, ya'ni funksiya grafigi bu nuqtada buriladi.

V.6-rasmda funksiya  $B$  nuqtada bukiladi,  $x = d$  da uziladi, uning chap va o'ng tomonlarida hosila mavjud va turli ishoralarga ega, nuqtaning o'zida ekstremumga ega emas. V.5-rasmda garchi  $x_2$  nuqtada  $f' = 0$  bo'lsa-da, bu nuqtada ekstremum yo'q, grafik bukilishga ega.

1 - misol.  $y = x^3 - x^2 - x$  funksiyaning maksimum va minimumini topamiz.

Yechish. Ekstremumga „shubhali“ nuqtalarni topamiz. Buning uchun  $y' = 0$  tenglamani yechamiz.  $y' = 3x^2 - 2x - 1 = 0$  tenglamaning ildizlari  $-\frac{1}{3}$  va 1. Funksiyaning  $x = -\frac{1}{3}$  nuqta atrofidagi holatini tekshiramiz:

$x < -\frac{1}{3}$ da	$x = -\frac{1}{3}$ da	$x > -\frac{1}{3}$ da
$y' > 0$	$y' = 0$	$y' < 0$

Bu nuqtada  $y'$  ning ishorasi «+» dan «-» ga o'zgarmoqda. Demak, funksiya  $x = -\frac{1}{3}$  da maksimumga erishadi, funksiyaning bu qiymatini topish uchun  $x = -\frac{1}{3}$  ni funksiya ifodasiga qo'yamiz:

$$f\left(-\frac{1}{3}\right) = \left(-\frac{1}{3}\right)^3 - \left(-\frac{1}{3}\right)^2 - \left(-\frac{1}{3}\right) = \frac{5}{27}.$$

$x = 1$  nuqta ham shu kabi tekshiriladi:

$x < 1$ da	$x = 1$ da	$x > 1$ da
$y' < 0$	$y' = 1$	$y' > 0$

Funksiya  $x = 1$  da minimumga erishadi. Uni hisoblaymiz:  
 $f(1) = 1^3 - 1^2 - 1 = -1$ . Shunday qilib,  $(-\frac{1}{3}; \frac{5}{27})$  – funksiyaning maksimum nuqtasi,  $(1; -1)$  – minimum nuqtasi.

2 - misol.  $\sqrt[3]{x^2}$  funksiya ekstremumga ega bo'lishi mumkin bo'lgan nuqtalarni aniqlaymiz va ekstremumlarni hisoblaymiz.

Yechish.  $y' = (\sqrt[3]{x^2})' = \left(x^{\frac{2}{3}}\right)' = \frac{2}{3}x^{\frac{2}{3}-1} = \frac{2}{3\sqrt[3]{x}} \Rightarrow D(y') =$

$= R \setminus \{0\}$ .

Barcha  $x \neq 0$  nuqtalarda  $y' \neq 0$ . Demak,  $x \neq 0$  da hosila mavjud, lekin u nolga teng emas, funksiya ekstremumga erishmaydi.

$x = 0$  da esa hosilaning ta'rifi bo'yicha:

$$f'(0) = \lim_{h \rightarrow 0} \frac{f(h) - f(0)}{h} = \lim_{h \rightarrow 0} \frac{\sqrt[3]{h^2}}{h} = \lim_{h \rightarrow 0} \frac{1}{\sqrt[3]{h}} = \infty.$$

Hosilaning  $x = 0$  nuqta atrofidagi ishoralarini aniqlaymiz: hosilaning ishorasi manfiy,  $\infty$  orqali musbatga o'zgarib borganida  $x = 0$  nuqtada funksiya hosilasi mavjud emas, lekin unda funksiya minimumga erishadi (V.7-rasm). Uni topamiz:  $y = \sqrt[3]{0^2} = 0$ . Shunday qilib,  $(0; 0)$  – minimum nuqtasi, unda funksiya grafigi *sinadi*.

$x < 0$ da	$x = 0$ da	$x > 0$ da
$y' < 0$	$\infty$	$y' > 0$

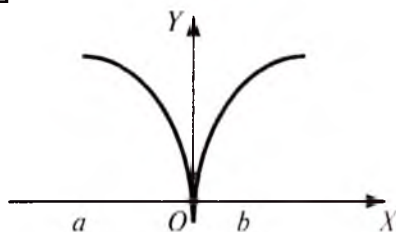

V.7-rasm.



## Mashqlar

5.69. Funksiyalarni ekstremumga tekshiring:

1)  $x^3 + x^2 + 6$ ;

2)  $x^3 + x^2 - x + 3$ ;

3)  $\frac{x^3}{3} - \frac{x^2}{2} - 2x + 1$ ;

4)  $\frac{x-4}{x^2+4}$ ;

5)  $\frac{x^2}{1+x^2}$ ;

6)  $\sqrt[3]{x^2}(x+9)$ ;

7)  $\frac{\sqrt{x+1}}{x-1}$ ;

8)  $\sqrt[3]{(x-2)^2} + \sqrt[3]{(x+2)^2}$ ;

9)  $ax^2 + bx + c$ ,  $a > 0$ ,  $a < 0$ ;

10)  $x + \frac{a}{x}$ ,  $a > 0$ ,  $x > 0$ .

### 2. Funksiyaning kesmadagi eng katta va eng kichik qiymatlarini

**topish.** Bu turdagi masalalar bilan oldin ham shug'ullanganmiz (Koshi tengsizligi va hokazo). Endi ularda hosilaning tatbiqi bilan tanishamiz. V.8-rasmda  $f(x)$  uzluksiz funksiyaning  $[a; b]$  kesmada mos qiymatlari to'plami  $[m; M]$  kesmadan iboratligi tasvirlangan. Bu qiymatlardan eng kichigi  $y_{e.kich.} = m$  ga, eng kattasi  $y_{e.kat.} = M$  ga teng. Ular  $[a; b]$  kesmaning uchlariga (masalan, chizmada  $x = b$  ga), ekstremum beradigan, ya'ni hosila nolga aylanadigan nuqtalarga ( $B, D$  minimum nuqtalariga,  $E$  maksimum nuqtasiga), V.7-rasmda tasvirlanganidek hosila cheksizlikka aylanadigan nuqtalarga ( $O$  nuqta – minimum nuqtasi, eng kichik qiymat nuqtasi), V.9-rasmda tasvirlangandek  $x = c$  uzilish nuqtasiga to'g'ri kelishi mumkin. Keyingi holda funksiyaning eng katta qiymati  $f(c) = M$ , eng kichik qiymati  $f(c) = 0$ .

Uzluksiz funksiyaning  $[a; b]$  kesmadagi eng katta va eng kichik qiymatlarini izlash tartibi quyidagicha:

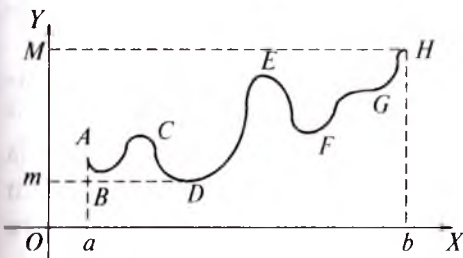

V.8-rasm.

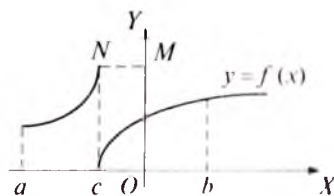

V.9-rasm.

a) funksiyaning kesma uchlaridagi  $f(a)$  va  $f(b)$  qiymatlarini topish;

b) hosila  $f' = 0$  bo'ladigan nuqtalarda funksiyaning qiymatlarini topish;

d) hosila mavjud bo'lmagan nuqtalardagi funksiyaning qiymatlarini topish;

e) bu topilgan barcha qiymatlardan eng katta va eng kichigini aniqlash kerak.

Ba'zan quyidagi hollardan foydalanish ishni yengillashtiradi:

1) agar  $f(x)$  funksiya  $x_0$  nuqtada o'zining eng katta (eng kichik) qiymatini qabul qilsa,  $f(x) + A$ ,  $f(x) \cdot B$  (bunda  $B > 0$ ) funksiyalar ham, shuningdek,  $f(x) \geq 0$  bo'lganda  $(f(x))^n$ ,  $n \in \mathbb{N}$  ham shu nuqtada o'zining eng katta (eng kichik) qiymatini qabul qiladi. Faqat  $B < 0$  bo'lganda  $f(x) \cdot B$  funksiya, aksincha, eng kichik (eng katta) qiymatga erishishi mumkin. Masalan,  $y = x^2$  kabi  $y = 3x^2 + 5$ ,  $y = (x^2)^2$ ,  $y = 3x^4 - 5$  funksiyalar ham  $[-1; 2]$  kesmada eng katta qiymatni  $x = 2$  da, eng kichik qiymatni  $x = 0$  da qabul qiladi;

2) agar  $f$  funksiya  $x_0$  nuqtada eng katta (eng kichik) qiymatni qabul qilgan bo'lsa, shu nuqtada  $-f$  va  $\frac{1}{f}$  funksiyalar o'zlarining eng kichik (mos ravishda eng katta) qiymatini qabul qiladi.

1 - m i s o l. 12 sonini shunday ikki qo'shiluvchiga ajrataylikki, ularning ko'paytmasi eng katta bo'lsin.

**Y e c h i s h .** Birinchi qo'shiluvchi  $x$ , ikkinchisi  $12 - x$  bo'lsin. Masala  $y = x(12 - x)$  ning  $0 \leq x \leq 12$  kesmadagi eng katta qiymatini topishga keladi.  $y' = 12 - 2x = 0$  bo'yicha  $x = 6$  ni topamiz. Funksiyaning  $[0; 12]$  kesmaning uchlaridagi va  $x = 6$  dagi qiymatlarini topish, so'ng ulardan eng kattasini aniqlash kerak:

$$f(0) = 0, \quad f(12) = 0, \quad f(6) = 36.$$

Demak, 12 soni 6 va 6 dan iborat qo'shiluvchilarga ajratilsa, ko'paytma eng katta bo'ladi.

2 - m i s o l. Kesimi to'g'ri to'rtburchak shaklida bo'lgan sterjenning bukilishga qarshiligi  $Q = kxy^2$  munosabat bo'yicha hisoblanadi, bunda  $k$  - proporsionallik koeffitsiyenti. Kesim qanday bo'lganda sterjen eng katta qarshilikka ega bo'ladi?

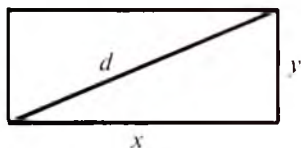

V.10-rasm.

**Y e c h i s h .** V.10-rasmdan



$$y^2 = d^2 - x^2, Q = kx(d^2 - x^2), 0 \leq x \leq d$$

larni aniqlaymiz.  $Q' = kd^2 - 3kx^2 = 0$  tenglamaning ildizlari:  $-\frac{d}{\sqrt{3}}$  va  $\frac{d}{\sqrt{3}}$ . Ulardan  $\frac{d}{\sqrt{3}}$  ildiz  $[0; d]$  kesmada joylashgan.  $Q = kx(d^2 - x^2)$  funksiyaning  $x_1 = 0$ ;  $x_2 = \frac{d}{\sqrt{3}}$ ;  $x_3 = d$  lardagi qiymatlarini topish va ulardan qiymati eng kattasini aniqlash kerak.  $x_1 = 0$  va  $x_3 = d$  da  $Q = 0$ ,  $x = \frac{d}{\sqrt{3}}$  da esa  $Q = k \cdot \frac{d}{\sqrt{3}} \cdot \left(\frac{\sqrt{2}d}{\sqrt{3}}\right)^2$ , bundan  $y = \frac{\sqrt{2}d}{\sqrt{3}}$ . Shunday qilib, kesimning bo'yi va eni  $\frac{y}{x} = \sqrt{2} = \frac{7}{5}$  nisbatda olinishi kerak.

**3 - misol.**  $x + z = C$  bo'lsin,  $x, z$  — o'zgaruvchi kattaliklar,  $C$  — doimiy son.  $x = z$  bo'lsagina,  $xz$  ko'paytma eng katta bo'lishini isbot qilamiz.

**Isbot.** 1-misol natijalaridan foydalanamiz.  $y = x(C - x)$  yoki  $y = Cx - x^2$  funksiyaning  $(-\infty; +\infty)$  intervaldagi eng katta qiymatini topishimiz kerak. Funksiya intervalning uchlarida  $-\infty$  ga aylanadi.

Ekstremum beradigan nuqtalarini aniqlaymiz:  $y' = C - 2x = 0$ , bundan  $x_0 = \frac{C}{2}$ . Unda:

$x$	$x < x_0$	$x = x_0$	$x > x_0$
$y'$	-	0	+

$x = \frac{C}{2}$  da funksiya maksimumga erishadi. Bu  $z = C - x = C - \frac{C}{2} = \frac{C}{2}$  ga to'g'ri keladi. Demak, funksiya  $x = z$  da eng katta qiymatga ega bo'ladi.

**4 - misol.**  $y = x^4(27 - x^4)$  funksiyaning  $[-2; 2]$  dagi eng katta qiymatini topamiz.

**Yechish.** 3-misol xulosasidan foydalanamiz. Funksiya  $x$  ning ixtiyoriy qiymatida aniqlangan va juft ekanidan uni  $[0; 2]$  kesmada qarash kifoya. Topilgan natija (simmetriyaga ko'ra) barcha  $[-2; 2]$  kesmaga nisbatan umumlashtiriladi. Funksiya ifodasi  $x$  ning har qanday qiymatida musbat bo'lgan  $x^4$  va  $32 - x^4$  ko'paytuvchilar ko'paytmasidan iborat, ularning yig'indisi  $x^4 + (32 - x^4) = 32$  — o'zgarmas. Demak,  $x = 2$  da funksiya  $x$  ning  $x^4 = 32 - x^4$  tenglikni



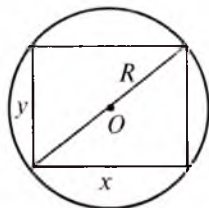

V.11-rasm.

qanoatlantiruvchi qiymatlarida eng katta qiymatga erishadi. Eng katta qiymat  $y = 2^4 \cdot (32 - 2^4) = 256$ .

5-misol. Radiusi  $R$  bo'lgan doira ichiga chizilgan to'g'ri to'rtburchaklardan yuzi eng kattasini topamiz.

Yechish. Chizmadan  $y = \sqrt{4R^2 - x^2}$ ,

to'rtburchak yuzi  $S = x\sqrt{4R^2 - x^2}$ , bunda  $x$  va  $\sqrt{4R^2 - x^2}$  ko'paytuvchilar musbat, demak,  $S > 0$ .  $S$  va  $S^2$  funksiyalar o'zlarining eng katta qiymatlarini bitta  $x$  nuqtada qabul qiladi. Bu nuqtani topamiz (V.11-rasm):

$$\begin{aligned}(S^2)' &= (x\sqrt{4R^2 - x^2})' = (4R^2x^2 - x^4)' = \\ &= 8R^2x - 4x^3 = 0.\end{aligned}$$

Buning ildizlari:  $0, R\sqrt{2}, -R\sqrt{2}$ . Lekin  $0 \in [0; 2R]$ ,  $R\sqrt{2} \in [0; 2R]$ . Endi  $S^2 = x^2(4R^2 - x^2)$  funksiyaning  $0; R\sqrt{2}; 2R$  nuqtalardagi qiymatlarini hisoblaymiz.  $x = 0$  va  $x = 2R$  da funksiya nolga aylanadi.  $S$  va  $S^2$  funksiyalar eng katta qiymatni  $x = R\sqrt{2}$  da qabul qiladi. Bu holda  $y = \sqrt{4R^2 - (R\sqrt{2})^2} = R\sqrt{2}$ , ya'ni  $x = y$  bo'lmoqda. Demak, doira ichiga chiziladigan to'g'ri to'rtburchaklardan yuzi eng kattasi kvadrat bo'lar ekan.



## Mashqlar

5.70. Funksiyalarning eng katta va eng kichik qiymatlarini toping:

1)  $x + 3\sqrt{x}$ ,  $x \in [0; 9]$ ;      2)  $x^5 - 6x^4 + 9x^3 + 1$ ,  $x \in [-3; 3]$ ;

3)  $x^3 + x^2 - x + 2$ ,  $x \in [-1; 1]$ ;      4)  $\frac{2x}{x+1}$ ,  $x \in [0; 6]$ .

5.71. 5.53-mashqda keltirilgan trigonometrik ifodali funksiyalarning eng katta va eng kichik qiymatlarini toping.

5.72. Funksiyalarning eng kichik qiymatlarini toping:

1)  $y = x + \frac{16}{x-2}$ ,  $x > 2$ ;      2)  $y = 5x + \frac{180}{x-1}$ ,  $x > 1$ ;

3)  $y = \frac{(x+1)(x+4)}{x}$ ,  $x > 0$ ;      4)  $y = \frac{(2x+5)(5x+14)}{x}$ ,  $x > 0$ .

**5.73.** Ko'ndalang kesimi to'g'ri to'rtburchak shaklida kanal qazilmoqda (V.12-rasm). Uning  $x$  chuqurligi va  $y$  kengligi  $2x + y = 3$  (m) shart bo'yicha aniqlanadi, bunda kesim perimetri  $R$  berilgan.  $x$  va  $y$  ning qanday qiymatlarida kesimning yuzi eng katta bo'ladi?



V.12-rasm.

**5.74.** To'g'ri to'rtburchakli parallelepipedning balandligi asosining diagonaliga teng va asosining yuzi  $4 \text{ m}^2$ . Asosining tomonlari va balandligi qanday uzunlikda tanlansa, parallelepipedning hajmi eng kichik bo'ladi?

**5.75.** O'tkazgichning har kilometr uzunligiga sarf bo'ladigan  $Q$  quvvat  $Q = 9x + \frac{4}{x} + 2$  formula bo'yicha hisoblanadi,  $x$  — har kilometrga to'g'ri keladigan qarshilik.  $x$  ning qanday qiymatida  $Q$  eng kichik qiymatga ega bo'ladi?

**5.76.** Elektr elementi beradigan energiya  $W = \frac{E^2 x}{(r+x)^2}$  formula bo'yicha hisoblanadi, bunda  $E$  — doimiy elektr yurituvchi kuch,  $r$  — doimiy ichki qarshilik.  $x$  ning qanday qiymatida  $W$  energiya eng katta qiymatga ega bo'ladi?

**5.77.** Tomoni  $a$  ga teng kvadrat shaklidagi tunukaning burchaklaridan shunday bir xil kvadratchalar kesib olinishi kerakki, natijada chekkalari bukilsa, hajmi eng katta bo'lgan quti hosil bo'lsin (V.13-a rasm). Kvadratchalarning tomoni qanday bo'lishi kerak?

**5.78.**  $\sqrt{x-2} + \sqrt{16-x}$  funksiyaning eng katta qiymatini toping.

**5.79.** Ko'rsatilgan kesmada  $f(x)$  funksiya qabul qiladigan eng katta qiymatni toping:

a)  $-7x^4 + 100x^3$ ,  $\left[0; 14\frac{2}{7}\right]$ ;

b)  $-x^4 + 4x^3$ ,  $[0; 4]$ .

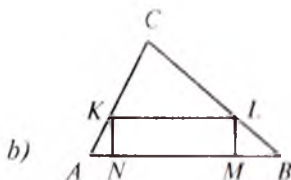
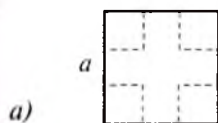

V.13-rasm.

**5.80.**  $f(x) = |x - 1| + |x - 2| + |x - 3| + |x - 4|$  funksiyaning eng kichik qiymatini toping.

**5.81.**  $ABC$  uchburchakda (V.13-*b* rasm)  $AB$  asosga parallel qilib shunday  $KL$  to'g'ri chiziq o'tkazingki, hosil bo'ladigan  $KLMN$  to'g'ri to'rtburchakning yuzi eng katta bo'lsin.

**5.82.** Radiusi  $a$  ga teng bo'lgan yarim shar atrofiga hajmi eng kichik bo'ladigan konus chizing.

**5.83.** Balandligi  $h$  ga, asosining radiusi  $r$  ga teng bo'lgan konus ichiga hajmi eng katta bo'lgan silindr chizing.

**5.84.** Transport xarajati  $f(v) = a + bv^3$  formula bo'yicha hisoblanadi, bunda  $a$  va  $b$  — o'zgarmas sonlar,  $v$  — transport harakat tezligi,  $a$  — amortizatsiya xarajatlari,  $bv^3$  — yonilg'i haqi. Qanday tezlik bilan harakat qilinsa,  $s$  masofani o'tishdagi xarajat eng kam bo'ladi?

**3. Lagranj teoremasi. Funksiyaning o'sishi va kamayishi.** (Lagranj Jozef Lui, 1736–1813, fransuz matematigi va mexanigi). Biz oldingi bandlarda funksiyaning nuqtadagi holatini tekshirish bilan shug'ullandik. Funksiyaning butun bir oraliqdagi holatini o'rganishda bir qator teoremlarga tayaniladi. Ulardan biri Lagranj teoremasi bo'lib, u ko'rsatilgan oraliqda funksiya orttirmasi bilan hosilasi o'rtasidagi bog'lanishga bag'ishlanadi.

$f(x)$  funksiya  $[a; b]$  kesmada uzluksiz bo'lsin.  $l$  to'g'ri chiziq  $f$  funksiyaga uringan holda  $A$  nuqta tomon to'xtovsiz burilib borsin (demak, funksiya uzluksiz hosilaga ega, V.14-rasm). U holda  $A$  va  $B$  nuqtalar orasida shunday  $C$  nuqta topiladiki, unda urinma  $AB$  vatarga parallel bo'lib qoladi. Bu holda urinmaning  $f'(c) = \tan \varphi$  burchak koeffitsiyenti vatarning  $\frac{f(b)-f(a)}{b-a}$  burchak koeffitsiyentiga

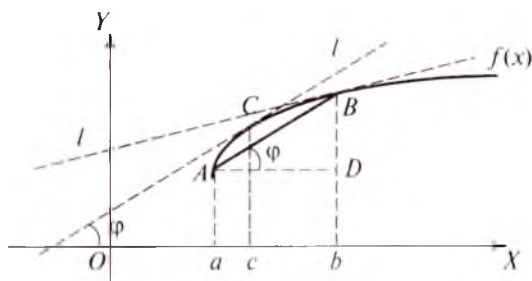

V.14-rasm.

teng bo'ladi, bunda  $a < c < b$ . Bunday xossaga ega bo'lgan  $C$  nuqtaning mavjudligini Lagranj teoremasi ta'kidlaydi:

**1 - teorema (Lagranj teoremasi).**  $f(x)$  funksiya  $[a, b]$  kesmada uzluksiz va uning ichki nuqtalarida differentsiallanuvchi bo'lsin. U holda bu kesmada shunday  $x = c$  nuqta topiladiki, unda ushbu tenglik o'rinli bo'ladi:

$$\frac{f(b)-f(a)}{b-a} = f'(c). \quad (1)$$

**1 - xulosa.** Agar  $f(x)$  funksiya  $[a, b]$  kesmada uzluksiz, kesmaning ichida funksiya hosilasi nolga teng bo'lsa,  $f(x)$  funksiya  $[a, b]$  kesmada o'zgarmas funksiya bo'ladi.

**Isbot.** Shart bo'yicha  $f'(c) = 0$ . U holda ixtiyoriy  $x \in (a, b)$  uchun:

$$f(x) - f(a) = f'(c)(x - a) \Rightarrow f(x) - f(a) = 0 \Leftrightarrow f(x) = f(a) = \text{const.}$$

**2 - xulosa.**  $[a, b]$  kesmada uzluksiz bo'lgan  $f(x)$  va  $g(x)$  funksiyalar kesmaning ichida bir xil hosilaga ega bo'lsa (ya'ni  $f'(x) = g'(x)$ ), bu funksiyalar o'zgarmas qo'shiluvchi bilangina farq qiladi.

**Isbot.** Istalgan  $x \in (a, b)$  uchun

$$f(x) = f(a) + f'(c)(x - a) \quad \text{va} \quad g(x) = g(a) + g'(c)(x - a)$$

bo'lsin. Shartga ko'ra  $f'(c) = g'(c)$ . Shunga ko'ra

$$f'(c)(x - a) = g'(c)(x - a) \Rightarrow f(x) - g(x) = f(a) - g(a) = A = \text{const.}$$

Demak,  $f - g = A$  yoki  $f = g + A$ .

**2 - teorema.** Agar  $f(x)$  funksiya  $X$  oraliqda uzluksiz, hosilasi esa shu oraliqda musbat (yoki manfiy) bo'lsa, funksiya oraliqning ichki nuqtalarida o'sadi (mos ravishda kamayadi).

**Isbot.**  $x_1$  va  $x_2$  nuqtalar  $X$  oraliqdan olingan va  $x_1 < x_2$  bo'lsin. Shartga ko'ra oraliq ichida  $f' > 0$ , jumladan  $c \in (x_1, x_2)$  nuqtada  $f'(c) > 0$ . Lagranj teoremasiga muvofiq  $f(x_2) - f(x_1) = f'(c)(x_2 - x_1)$ , bunda  $f'(c) \cdot (x_2 - x_1) > 0$ . Bunga qaraganda  $f(x_2) > f(x_1)$ , ya'ni  $X$  oraliqda  $f(x)$  funksiya o'sadi.

$X$  da  $f'(x) < 0$  bo'lgan hol ham shu kabi qaraladi.

Teoremaning kuchaytirilgan ko'rinishi: Agar  $f$  funksiya  $X$  oraliqda uzluksiz, hosilasi nomanfiy (nomusbat) va faqat ichki nuqtalarning chekli to'plamida nolga teng bo'lsa,  $f$  funksiya shu oraliqda o'sadi (kamayadi).

V.5-rasmda tasvirlanishicha  $[x_0; x_3]$  kesmaning ichki  $x_2$  nuqtasidagina  $f'$  nolga teng (unda funksiya grafigi bukiladi), qolgan nuqtalarda funksiyaning hosilasi musbat va funksiya o'sadi.

**3 - t e o r e m a .** Agar  $f$  funksiya  $x_0$  nuqtada uzluksiz, hosilasi shu nuqtaning chap yaqinida musbat (mos ravishda manfiy), o'ng yaqinida manfiy (musbat) bo'lsa,  $f$  funksiya  $x_0$  nuqtada maksimumga (minimumga) erishadi.

**I s b o t .**  $x_0$  dan chapda  $f' > 0$  bo'lsa, unda funksiya o'sadi,  $x_0$  dan o'ngda  $f' < 0$  bo'lsa, bu tomonda funksiya kamayadi. U holda funksiya  $x_0$  nuqtaning o'zida nuqtaning chap va o'ng yaqinidagiga nisbatan kattaroq qiymatni qabul qiladi. Demak,  $x_0$  nuqta — funksiya maksimum nuqtasining absissasi.

Teoremaning funksiya minimumiga oid qismi ham shu kabi isbotlanadi.



## Mashqlar

**5.85.** Quyidagi funksiyalar va kesmalar uchun Lagranj teoremasida ko'rsatilgan  $x = c$  ning qiymatini toping:

1)  $x^3 + 2x - 1$ ,  $[-1; 2]$ ;

2)  $x^4 + 4x - 1$ ,  $[-1; 1]$ ;

3)  $(x - 2)(x^2 + 9)$ ,  $[-2; 2]$ ;

4)  $(x^2 + 4)(x^2 + 9)$ ,  $[-4; 4]$ .

**5.86.**  $f(x) = x^2 - px - q$  funksiya va istalgan  $[a; b]$  kesma uchun  $c = \frac{a+b}{2}$  (5.85-mashqqa qarang) tenglikning bajarilishini isbot qiling.

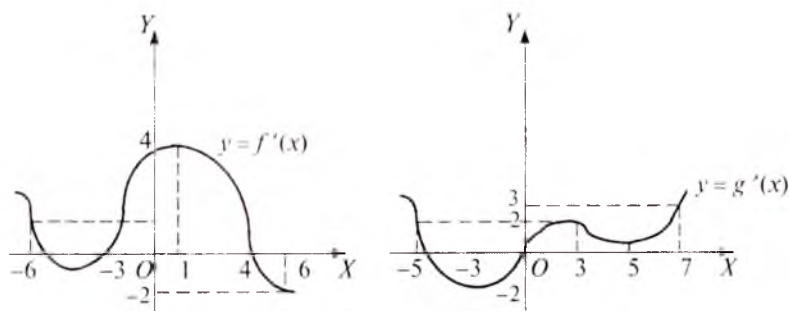

V.15-rasm.

**5.87.** Funksiyalarni o'lish-kamayishga tekshiring va grafiklarini sxematik tasvirlang:

1)  $y = x^5 - 3x^3 - 5$ ;

2)  $y = 2e^{-x}$ ;

3)  $y = 5(x^5 - 15x^2 + 36x - 1)$ .

**5.88.** 1) 5.69-mashqda keltirilgan funksiyalarni o'lish va kamayishga tekshiring;

2) V.15-rasmda  $f'(x)$  va  $g'(x)$  hosila funksiyalarning grafiklari tasvirlangan.  $f$  va  $g$  funksiyalarning grafiklarini sxematik tasvirlang:

3)  $y = x^2 + 7$  funksiyaning o'zgarishini tekshiring.

**4. Funksiya grafigining qavariqligi.** Biz quyi sinflardan oq  $y = Ax^2 + Bx + C$  kvadrat funksiya grafigi (parabola)  $A > 0$  da qavariqligi bilan pastga,  $A < 0$  da qavariqligi bilan yuqoriga yo'nalganligini bilamiz.  $A$  sonning ishorasi shu funksiyadan olingan  $y''$  hosilaning ishorasi bilan bir xil:  $y'' = (Ax^2 + Bx + C)'' = (2Ax + B)' = 2A$ . Bu ta'kid har qanday funksiya uchun o'rinlidir (bunda botiqlik qavariqlikka nisbatan qarama-qarshi yo'nalish deb qaralishi kerak).

**1 - teorema.** Agar  $f(x)$  funksiya  $[a; b]$  kesmada uzluksiz, kesmaning ichida  $f''(x) > 0$  (mos ravishda  $f'' < 0$ ) bo'lsa,  $f$  funksiya grafigi shu kesmada qavariqligi bilan pastga (mos ravishda yuqoriga) tomon yo'nalgan bo'ladi.

**Isbot.**  $(a; b)$  da  $f''(x) > 0$  bo'lgan holni qaraylik (V.16-a rasm). Ixtiyoriy  $c \in (a; b)$  nuqtani tanlab,  $M(c; f(c))$  nuqtadan  $f$  grafigiga urinma o'tkazamiz. Urinma to'liq grafikning ostiga joylanishini, ya'ni

$$y_{\text{eg.chiz.}} - y_{\text{urin.}} = f(x) - [f(c) + f'(c)(x - c)] > 0$$

bo'lishini isbot qilishimiz kerak.  $x < c$  nuqtani olaylik ( $x < c$  holi ham shu tariqa qaraladi).  $[c; x]$  kesmaga nisbatan Lagranj teoremasini qo'llaymiz:  $f(x) - f(c) = f'(c_1)(x - c)$ , bunda  $c < c_1 < x$ . U holda

$$\begin{aligned} y_{\text{eg.chiz.}} - y_{\text{urin.}} &= [f(c) + f'(c_1)(x - c)] - [f(c) + f'(c)(x - c)] = \\ &= (f'(c_1) - f'(c))(x - c). \end{aligned} \quad (1)$$

Shu kabi  $f'(x)$  funksiya va  $[c; c_1]$  kesmaga nisbatan Lagranj teoremasi qo'llanilsa:  $f'(c_1) - f'(c) = f''(c_2)(c_1 - c)$ , bunda  $c < c_2 < c_1$ . U holda (1) munosabat quyidagi ko'rinishga keladi:

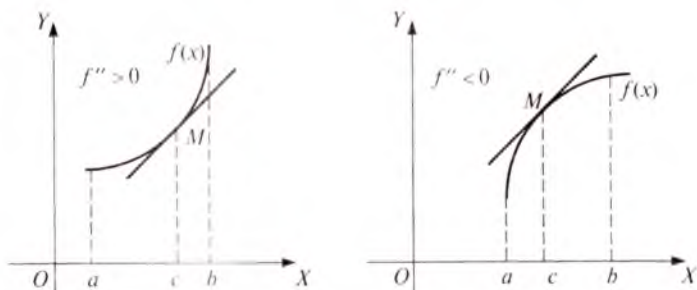

V.16-rasm.

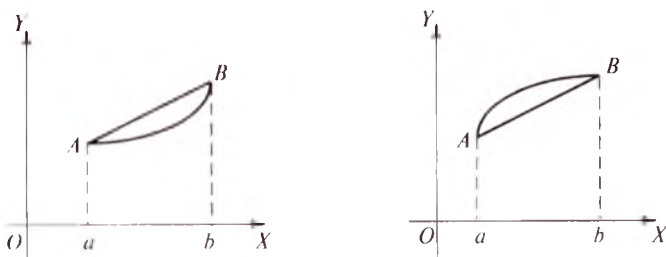

V.17-rasm.

$$y_{\text{eg.chiz.}} - y_{\text{urin.}} = f''(c_2)(c_1 - c)(x - c), \quad c < c_2 < c_1.$$

$c_1$  va  $x$  nuqtalar  $c$  nuqtaning bir tomonida yotganligidan  $(c_1 - c)(x - c) > 0$ , shart bo'yicha esa  $f'' > 0$ . Demak, keyingi tenglikdan  $y_{\text{eg.chiz.}} - y_{\text{urin.}} > 0$  bo'lishi ma'lum bo'ladi.

$[a; b]$  kesma ichida  $f''(x) < 0$  bo'lgan hol ham shu kabi qaraladi (V.16-b rasm).

**2- teorema.** Agar  $[a; b]$  kesmada  $f(x)$  funksiya grafigi qavariqligi bilan pastga (mos ravishda yuqoriga) tomon yo'nalgan bo'lsa,  $[a; b]$  kesmaning ichida bu grafik  $AB$  vatarining ostiga (mos ravishda ustiga) joylashadi, bunda  $A(a; f(a))$ ,  $B(b; f(b))$  (V.17-a, b rasm).

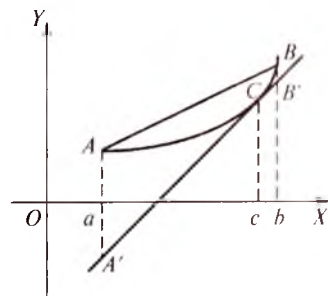

V.18-rasm.

**Isbot.** Funksiya grafigi qavariqligi bilan pastga yo'nalgan bo'lsin (V.18-rasm). Bu holda grafik uning ixtiyoriy nuqtasidan o'tkazilgan urinmaning ustiga joylashadi. Xususan,  $A$  nuqta  $A'$  nuqtadan,  $B$  esa  $B'$  dan yuqorida.  $C$  urinish nuqtasi  $AB$  vatardan quyida joylashgan bo'ladi. Bu hol  $AB$



yoyni barcha  $C$  nuqtalari uchun o'rinli. Bu hol  $AB$  yoyni barcha  $C$  nuqtalari uchun o'rinli bo'lganidan yoy to'laligicha  $AB$  vatarning ostiga joylashadi.

Grafik qavariqligi bilan yuqoriga qaragan hol ham shu kabi isbotlanadi.

1 - misol.  $f(x) = x^6$  funksiya grafigi qavariqligi bilan qaysi tomonga yo'nalganligini aniqlaymiz.

Yechish.  $f''(x) = (x^6)'' = (6x^5)' = 30x^4$ . Bunda  $30x^4 \geq 0$  va faqat  $x = 0$  da nolga aylanadi. Demak,  $f(x) = x^6$  funksiya grafigi barcha nuqtalarda qavariqligi bilan quyi tomonga yo'nalgan.

2 - misol.  $f(x) = x^4 - 6x^2 + 5$  funksiya grafigi qavariqligi bilan yuqoriga va quyiga tomon yo'naladigan oraliqlarni topamiz.

Yechish.  $f'(x) = 4x^3 - 12x$ ,  $f''(x) = 12x^2 - 12 = 12(x-1)(x+1)$ . Bu tenglik  $x = -1$  va  $x = 1$  da nolga aylanadi. Intervallar usuli bilan  $f''(x)$  ifoda ishoralari saqlanadigan oraliqlarni aniqlaymiz (jadvalga qarang).

	$(-\infty; -1)$	$(-1; 1)$	$(1; +\infty)$
$x - 1$	-	-	+
$x + 1$	-	+	+
$f''$	+	-	+

$(-\infty; -1]$  va  $[1; +\infty)$  intervallarda  $f(x)$  funksiya grafigi qavariqligi bilan quyiga,  $[-1; 1]$  da esa yuqoriga yo'nalgan.



## Mashqlar

**5.89.** Quyidagi funksiyalarning graflari qavariqligi bilan yuqoriga va quyiga tomon yo'nalgan oraliqlarni toping:

1)  $3x^4 - 4x^3$ ;                      2)  $x^3 - 3x^2 + 8x + 1$ ;

3)  $(x - 4)^4$ ;                      4)  $\frac{x^4 - 2}{x^3}$ .

**5. Funksiya grafigining bukilib nuqtalari.** V.5-rasmda tasvirlanishicha,  $f$  funksiya  $x_2$  nuqtada  $f' = 0$  hosilaga ega bo'lsa-da, funksiya unda ekstremumga erishmaydi: grafigi bukilib, urinmaning bir tomonidan ikkinchi tomoniga (chizmada urinmaning ostidan ustiga) o'tadi. Bunday nuqtalar  $f(x)$  egri chiziqning *bukilib nuqtalari* deyiladi.



1 - teorema. Agar  $c$  nuqtada  $f$  funksiyaning ikkinchi tartibli hosilasi uzluksiz va noldan farqli bo'lsa,  $C(c; f(c))$  nuqtada  $f$  funksiya grafigi bukilmaydi.

Isbot. Shart bo'yicha  $f''(c) \neq 0$  edi.  $f''(c) > 0$  bo'lsin.  $f''$  funksiya uzluksiz bo'lganligidan  $c$  nuqta yaqinida ham musbat. Bunga qaraganda  $f$  grafik qavariqligi bilan pastga yo'nalgan bo'lib,  $C$  nuqtadan o'tuvchi urinmadan yuqorida joylashadi, demak, grafik urinmani kesib o'tmaydi, bu nuqtada bukilmaydi.

$f''(c) < 0$  bo'lgan hol ham shu kabi isbotlanadi.

Xulosa.  $f(x)$  funksiya grafigi  $C(c; f(c))$  nuqtada bukilishi uchun yo  $c$  nuqtada  $f'' = 0$  bo'lishi, yoki  $c$  nuqta  $f''$  funksiya uchun uzilish nuqtasi bo'lishi, yoki  $c$  nuqtada  $f''$  hosila mavjud bo'lmasligi kerak.

Bayon qilingan xulosa bukilish nuqtasi bo'lish uchun zaruriy shartni beradi, lekin bu yetarlilik sharti emas. Masalan,  $y = x^4$  funksiyaning  $y'' = 12x^2$  ikkinchi tartibli hosilasi  $x = 0$  da nolga aylanadi, lekin bu nuqtada grafik bukilmaydi (V.19-rasm).

2 - teorema.  $f(x)$  funksiya  $c$  nuqtada differentsiallanuvchi va  $c$  nuqtaning  $h$  radiusli teshilgan atrofida  $f''$  hosilaga ega bo'lsin. Agar  $c$  nuqtadan o'tishda  $f''$  hosila ishorasi o'zgarsa,  $C(c; f(c))$  nuqta  $f$  funksiya grafigining bukilish nuqtasi bo'ladi.

Isbot.  $c$  nuqtadan chapdan o'ngga o'tishda  $f''$  ishorasi « $\rightarrow$ » dan « $\leftarrow$ » ga o'zgarsin. Bu holda  $f$  funksiya grafigi  $[c - h; c]$  chap kesmada qavariqligi bilan yuqoriga qaragan va  $c$  nuqtadan o'tuvchi urinmadan quyida joylashgan bo'ladi.  $[c; c + h]$  o'ng kesmada esa qavariqligi bilan quyiga qaragan bo'lib, o'sha urinmaning ustiga joylashadi. Demak,  $c$  nuqtada  $f(x)$  egri chiziq urinmaning ostki tomonidan ustki tomoniga o'tadi.

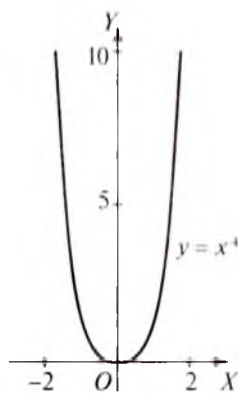

V.19-rasm.

Shu kabi  $c$  nuqtada  $f''$  ishorasi « $\leftarrow$ » dan « $\rightarrow$ » ga o'zgarsa,  $f$  egri chiziq urinmaning ustki tomonidan ostki tomoniga o'tadi. Demak, ikkala holda ham  $c$  nuqta funksiya bukilish nuqtasining absissasi bo'ladi.

Bukilish nuqtalari funksiya grafigining qavariq va botiq qismlarini bir-biridan ajratib turadi.

Misol.  $f(x) = \frac{1}{2}x^4 - 12x^2 + 6$  funksiya grafigi bukilishga egaligini tekshiramiz.

Yechish.  $f''(x) = (\frac{1}{2}x^4 - 12x^2 + 6)'' = (2x^3 - 24x)' = 6x^2 - 24 = 0$ .

Tenglamaning ildizlari:  $x = -2, x = 2$ . Bu qiymatlarda  $f'(-2) = f'(2) = -34$ . Grafik  $(-2; -34)$  va  $(2; -34)$  nuqtalarda bukilishi mumkin.  $x = -2$  nuqtaning  $x > -2$  yaqinida  $f'' = 6x^2 - 24 > 0$ ,  $x < -2$  da  $f'' > 0$ , ya'ni  $x = -2$  da  $f''$  ning ishorasi o'zgarimoqda. Demak,  $C_1(-2; 34)$  - bukilish nuqtasi. Shu kabi  $C_2(2; -34)$  ham bukilish nuqtasi ekani aniqlanadi.



## Mashqlar

**5.90.** 1) 5.89-mashqda keltirilgan funksiyalar grafiglarining bukilish nuqtalarini toping;

2)  $y = -x^{1/3}$  funksiya grafigining bukilish nuqtasini toping.

**6. Funksiya grafiglarini yasash tartibi.** Funksiya grafigini  $(x; f(x))$  nuqtalar bo'yicha yasashdan oldin funksiya va uning grafigining xususiyatlari o'rganilishi kerak. Bunda quyidagi ma'lumotlar to'planadi:

1)  $f(x)$  funksiyaning  $D(f)$  aniqlanish sohasi,  $E(f)$  qiymatlar sohasi, uzluksizligi;

2) funksiyaning juft-toqligi;

3) grafigining  $OX$  o'qi bilan kesishish nuqtalari (funksiyaning nollari). Buning uchun  $f(x) = 0$  tenglama yechilishi kerak;

4) funksiyaning nollari va uzilish nuqtalari absissalar o'qini funksiya ishoralari saqlanadigan oraliqlarga ajratadi. Bu oraliqlarda funksiyaning ishoralari;

5) uzilish nuqtalari yaqinida va cheksizlikda funksiyaning holati va asimptotalari;

6) funksiyaning o'sish va kamayish oraliqlari;

7) maksimum va minimumi;

8) grafigining qavariqligi, bukilish nuqtalari;

9) funksiya va uning hosilalari qiymatlari jadvali tuziladi (bunga oldin topilgan va boshqa kerakli nuqtalar ham kiritilishi mumkin);

10) funksiya grafigining eskizini chizish va xulosalar.

**1-misol.**  $f(x) = x^3 + 6x^2 + 8x$  funksiyaning tekshiramiz va grafigini yasaymiz.

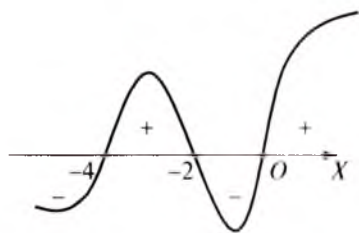

V.20-rasm.

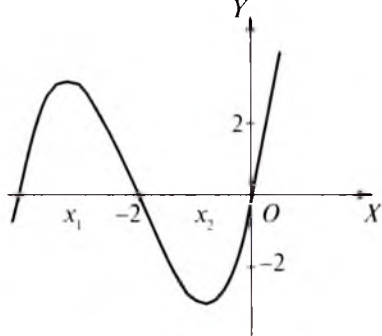

V.21-rasm.

Ye'chish. 1) Funksiya  $x$  ning har qanday qiymatida aniqlangan, ya'ni  $D(f) = (-\infty; +\infty)$ ;

2)  $f(-x) = (-x)^3 + 6(-x)^2 + 8(-x) = -x^3 + 6x^2 - 8x$ . Bunga qaraganda  $f(-x) \neq f(x)$  va  $f(-x) \neq -f(-x)$ , ya'ni qaralayotgan  $f(x)$  funksiya juft ham emas ( $OY$  o'qiga nisbatan simmetrik emas), toq ham emas (koordinatalar boshiga nisbatan simmetrik emas);

3) grafikning abssissalar o'qini kesish nuqtalarini topamiz. Buning uchun  $x^3 + 6x^2 + 8x = 0$  tenglamani yechamiz. Uning ildizlari: 0; -4; -2. Kesishish nuqtalari:  $A(-4; 0)$ ;  $B(-2; 0)$ ;  $O(0; 0)$  (V.20, V.21-rasmlar);

4)  $f(x)$  funksiya son o'qining barcha nuqtalarida uzluksiz. Uning nollari son o'qini to'rtta ishora saqlanadigan intervalga ajratadi (V.20-rasm). Tasvir bo'yicha funksiya  $(-4; -2)$  da maksimumga,  $(-2; 0)$  da minimumga ega bo'lishi kerak;

$$\begin{aligned} 5) \lim_{x \rightarrow +\infty} (x^3 + 6x^2 + 8x) &= \lim_{x \rightarrow +\infty} x^3 \left(1 + \frac{6}{x} + \frac{8}{x^2}\right) = \\ &= \lim_{x \rightarrow +\infty} x^3 \cdot \lim_{x \rightarrow +\infty} \left(1 + \frac{6}{x} + \frac{8}{x^2}\right) = +\infty \cdot 1 = +\infty. \end{aligned}$$

Shu kabi  $\lim_{x \rightarrow -\infty} (x^3 + 6x^2 + 8x) = -\infty$ . Demak, asimptotalarga ega emas, uzilish nuqtalari yo'q;

6)–7) funksiyaning o'sishi, kamayishi va ekstremum nuqtalari:

$$f'(x) = (x^3 + 6x^2 + 8x)' = 3x^2 + 12x + 8 = 0.$$

Bu tenglamaning ildizlari  $x_{1,2} \approx -2 + \frac{2}{3}\sqrt{3}$  yoki taqriban  $x_1 \approx -3,155$  va  $x_2 \approx -0,845$ . Funksiya  $x_1$  nuqtada maksimumga,

$x_2$  nuqtada minimumga erishadi, bunda  $x_1 \in (-4; -2)$ ,  $x_2 \in (-2; 0)$ . Ularda funksiya qiymatlari  $f(x_1) \approx 2,996$ ,  $f(x_2) \approx -3,079$ .

$(-\infty; x_1]$  kesmada  $f'(x) \geq 0$ . Demak, unda funksiya o'sadi;  $[x_1; x_2]$  da  $f' \leq 0$ , unda funksiya kamayadi;

$[x_2; +\infty)$  da  $f' \geq 0$ , funksiya o'sadi;

8)  $f''(x) = (x^3 + 6x^2 + 8x)'' = (3x^2 + 12x + 8)' = 6x + 12$ .  $f'' = 0$  tenglamaning ildizi  $x = -2$ . Grafikning bukilishini tekshiramiz.  $x < -2$  da  $f'' < 0$ ,  $x > -2$  da esa  $f'' > 0$ , ya'ni  $x = -2$  dan o'tishda  $f''$  hosila o'z ishorasini o'zgartirmoqda. Demak, bu nuqtada  $f(x)$  egri chiziq bukiladi. Bu nuqtadan chap tomonda grafik qavariqligi bilan yuqoriga, o'ng tomonda esa qavariqligi bilan pastga qaraydi. Bukilish nuqtasidan o'tuvchi urinuvchi to'g'ri chiziqning burchak koeffitsiyenti  $k = f'(-2) \approx -1,301$ ;

9) to'plangan ma'lumotlarni quyidagi jadvalga joylashtiramiz:

$x$	$(-\infty; -4)$	$-4$	$(-4; x_1)$	$x_1 \approx -3,15$	$(x_1; -2)$	$-2$	$(-2; x_2)$
$f(x)$	-	0	+	$\approx 2,9$	+	0	-
$f'(x)$	+	+	+	0	-	$\approx -1,301$	-
$f''(x)$	-	-	-	-	-	0	+
Funksiya	manfiy, o'sadi, qavariqligi yuqoriga yo'nalgan	O'X o'qini kesadi	musbat, o'sadi, qavariqligi yuqoriga yo'nalgan	maksimum	musbat, kamayadi, qavariqligi yuqoriga yo'nalgan	O'X o'qini kesadi, bukilish nuqtasi	manfiy, kamayadi, qavariqligi pastga yo'nalgan

davomi

$x$	$x_2 \approx -0,845$	$(x_2; 0)$	$0$	$(0; +\infty)$
$f(x)$	$-3,079$	-	0	+
$f'(x)$	0	+	+	+
$f''(x)$	+	+	+	+
Funksiya	minimum	manfiy, o'sadi, qavariqligi pastga yo'nalgan	O'X o'qini kesadi	musbat, o'sadi, qavariqligi pastga yo'nalgan

10) tekshirish natijalari bo'yicha funksiya grafisini yasaymiz (V.21-rasm).

2 - misol.  $f(x) = \frac{(x-1)^3}{(x+1)^2}$  funksiya grafisini yasaymiz.

Ye chish. Funksiya ifodasini  $f(x) = x - 5 + 4 \frac{3x+1}{(x+1)^2}$  sodda

ifodalar yig'indisi ko'rinishiga keltiramiz va tekshirishni bajaramiz:

1) funksiya  $x = -1$  dan tashqari hamma joyda aniqlangan,  $x = -1$  da  $\lim_{x \rightarrow -1} f(x) = -\infty$ ,  $\lim_{x \rightarrow -1} f(x) = -\infty$ , ya'ni bu nuqtada grafik cheksiz uzilishga ega va  $x = -1$  to'g'ri chiziq – vertikal asimptota. Tarmoqlarning ikkalasi ham quyi tomonga cheksiz yo'nalgan (V.22-rasm);

2) funksiya toq ham emas, juft ham emas (tekshirib ko'ring);

3) funksiya grafigi  $OX$  o'qini  $B(1; 0)$  nuqtada kesib o'tadi;

4)  $x = -1$  va  $x = 1$  nuqtalar  $OX$  o'qini  $(-\infty; -1)$ ,  $(-1; 1)$ ,  $(1; +\infty)$  intervallarga ajratadi. Funksiya  $(-\infty; -1)$  va  $(-1; 1)$  da manfiy,  $(1; +\infty)$  da musbat;

5) og'ma asimptotalarini aniqlaymiz:

$$\lim_{x \rightarrow \infty} \frac{3x+1}{(x+1)^2} = \lim_{x \rightarrow \infty} \frac{3 + \frac{1}{x}}{x(1 + \frac{1}{x})^2} = 0,$$

$$k = \lim_{x \rightarrow +\infty} \frac{f(x)}{x} = \lim_{x \rightarrow +\infty} \frac{x-5+4 \cdot \frac{3x+1}{(x+1)^2}}{x} = \lim_{x \rightarrow +\infty} \left( 1 - \frac{5}{x} + 4 \cdot \frac{3 + \frac{1}{x}}{(x+1)^2} \right) = 1,$$

$$b = \lim_{x \rightarrow +\infty} (f(x) - kx) = \lim_{x \rightarrow +\infty} \left( -5 + 4 \cdot \frac{3x+1}{(x+1)^2} \right) = -5.$$

Nuqta	$x$	$y$	$y'$	$y''$	
	-1	$-\infty$			uzilish
A	-5	-13,5	+0-		maksimum
B	1	0	+0+	-0+	bukilish
C	-7	-14,2			
D	0	-1			
E	-0,5	-13,5			
F	5	1,78			
	$-\infty$	$-\infty$			
	$+\infty$	$+\infty$			

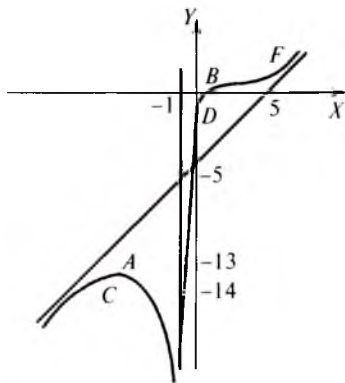

V.22-rasm.

Demak, og'ma asimptota  $h = x - 5$  to'g'ri chiziqdan iborat;

$$6) y' = \frac{(x-1)^2(x+5)}{(x+1)^3}; y'' = 24 \cdot \frac{x-1}{(x+1)^4}. \text{ Ikkala hosila ham } x = -1$$

nuqtadan boshqa hamma joyda aniqlangan.  $y' = 0$  tenglama  $x_1 = -5$  va  $x_2 = 1$  ildizlarga ega. Ularda  $y_1 = f(-5) = -13,5$ ,  $y_2 = f(1) = 0$ . Birinchi hosila  $(x_1; y_1)$  nuqta atrofida va o'zida «+», 0, «-» tartibda ishora almashtiradi,  $(x_2; y_2)$  atrofida «+», 0, «-» ga,  $y''$  esa «-», 0, «+» ga ega. Demak,  $(-5; -13,5)$  nuqta funksiyaning maksimum nuqtasi (chizmada  $A$  nuqta),  $B(1; 0)$  – bukilish nuqtasi.  $B$  nuqtadan chapda grafik qavariqligi bilan yuqoriga, o'ngda esa quyi tomonga yo'nalgan;

7)  $\lim_{x \rightarrow +\infty} (f(x) - (x - 5)) > 0$ ,  $\lim_{x \rightarrow -\infty} (f(x) - (x - 5)) < 0$ . Demak, grafikning o'ng tarmog'ining  $4 \cdot \frac{3x+1}{(x+1)^2} > 0$  bo'lgan, ya'ni  $x > -\frac{1}{3}$  dagi qismi va grafikning chap qismi shu asimptotadan quyida joylashadi. O'ng tarmoq  $(-\frac{1}{3}; -5\frac{1}{3})$  nuqtada  $y = x - 5$  to'g'ri chiziqni (asimptotani) kesib o'tadi va quyi tomonga cheksiz yo'naladi:  $x \rightarrow -1$  da  $y \rightarrow -\infty$ ;

8) olingan natijalarni jadvalga to'ldiramiz va grafik eskizini chizamiz:



## Mashqlar

**5.91.** Funktsiyalarni tekshiring va grafiklarini yasang:

$$1) (x-1)^2 x(x+1); \quad 2) \frac{x^2-4}{x(1-x^2)}; \quad 3) \frac{x^2-4}{1-x^2}; \quad 4) \frac{x^2+2x-2}{x-1};$$

$$5) \sqrt[3]{4-x^2}; \quad 6) \sqrt[3]{4-x^3}; \quad 7) \sqrt[3]{(x-1)^2} - \sqrt[3]{(x+1)^2}; \quad 8) \frac{4}{x\sqrt{x^2-1}};$$

$$9) x^3 - 6x^2 + 2x - 4.$$

**5.92.** 5.69 va 5.89-mashqlarda keltirilgan funksiylarning grafiklarini yasang.

**7. Hosila yordamida tengsizliklarni isbotlash.**  $x = a$  nuqtada  $f(x)$  funksiya uzluksiz va  $f(a) = 0$  bo'lsin. Agar  $[a; \infty)$  kesmada  $f' > 0$  bo'lsa, shu kesmada funksiya o'suvchi va  $x > a$  larda

$f(x) > f(a)$ , ya'ni  $f(x) > 0$  bo'ladi. Aksincha,  $f' < 0$  bo'lsa, funksiya kamayadi va  $x > a$  larda  $f(x) < f(a)$ , ya'ni  $f(x) < 0$  bo'ladi. Bu ta'kidlar bizga ma'lum. Ulardan tengsizliklarni isbotlashda foydalanamiz.

1 - misol.  $x > 1$  da  $\frac{1+x}{2} > \sqrt{x}$  tengsizlikning bajarilishini isbot qilamiz.

Isbot.  $f(x) = \frac{1+x}{2} - \sqrt{x}$  bo'lsin. Bundan:  $f'(x) = \frac{1}{2} - \frac{1}{2\sqrt{x}}$ ;  $x = 1$  da  $f(1) = 0$ ,  $(1; +\infty)$  da  $f' > 0$ . Demak,  $x > 1$  da  $f(x) > f(1)$ , ya'ni  $f(x) > 0$ . U holda

$$x > 1 \text{ da } \frac{1+x}{2} > \sqrt{x} \quad (1)$$

bo'lishi ma'lum bo'ladi.

Bu misolni biz Koshi tengsizligidan foydalanib, osonroq hal qilishimiz mumkin edi. Lekin har vaqt ham shunday bo'lavermaydi.

2 - misol. Agar  $a > 0$ ,  $x > 0$ ,  $n > 1$  bo'lsa,  $(a+x)^n > a^n + na^{n-1}x$  tengsizlikning o'rinli bo'lishini isbot qilamiz.

Isbot.  $f(x) = (a+x)^n - (a^n + na^{n-1}x)$  bo'lsin.  $x = 0$  da  $f(0) = 0$ . Ikkinchi tomondan,  $f'(x) = n(a+x)^{n-1} - na^{n-1}$ . Agar  $n > 1$ ,  $x > 0$ ,  $a > 0$  bo'lsa,  $n(a+x)^{n-1} > na^{n-1}$ , ya'ni  $f'(x) > 0$  bo'ladi. Demak,  $(0; +\infty)$  da  $f(x) > 0$  va

$$(a+x)^n > a^n + na^{n-1}x \quad (2)$$

o'rinli bo'lar ekan.

3 - misol. Agar  $a > 0$ ,  $x > 0$ ,  $n > 2$  bo'lsa,

$$(a+x)^n > a^n + na^{n-1}x + \frac{n(n-1)}{1 \cdot 2} a^{n-2}x^2 \quad (3)$$

tengsizlikning o'rinli bo'lishini isbot qilamiz.

Isbot.  $f(x) = (a+x)^n - \left( a^n + na^{n-1}x + \frac{n(n-1)}{1 \cdot 2} a^{n-2}x^2 \right)$  bo'lsin, bunda  $f(0) = 0$ .

$$\begin{aligned} f'(x) &= n(a+x)^{n-1} - na^{n-1} - n(n-1)a^{n-2}x = \\ &= n((a+x)^{n-1} - a^{n-1} - (n-1)a^{n-2}x); \end{aligned}$$

agar  $x > 0$  va  $n > 2$  bo'lsa,  $f'(x) > 0$  bo'ladi. Bunga qaraganda  $(0; +\infty)$  da  $f(x) > 0$ , demak, (3) tengsizlik ixtiyoriy  $a > 0$  va  $x > 0$ ,  $n > 2$  da o'rinli.

Endi ikkinchi tartibli hosiladan foydalanib, muhim tengsizliklardan yana birini isbot qilamiz.



Agar  $[a; b]$  kesmada  $f''(x) \geq 0$  bo'lsa, har qanday  $\lambda$ ,  $0 \leq \lambda \leq 1$  son uchun

$$f(\lambda b + (1 - \lambda)a) \leq \lambda f(b) + (1 - \lambda)f(a) \quad (4)$$

tengsizlik va shu shartlarda  $f''(x) < 0$  bo'lsa,

$$f(\lambda b + (1 - \lambda)a) \geq \lambda f(b) + (1 - \lambda)f(a) \quad (5)$$

tengsizlik bajariladi.

Isbot.  $[a; b]$  kesmada  $f''(x) \geq 0$  bo'lsa (V.18-rasm),  $f(x)$  grafikning shu kesmadagi qismi  $AB$  vatardan quyida joylashgan bo'ladi. Shunga ko'ra ixtiyoriy  $x = c \in [a; b]$  nuqtada  $cC$  ordinata  $cC_1$  ordinatadan katta bo'la olmaydi:  $cC < cC_1$ . Ordinalarni  $f(x)$  egri chiziq va  $AB$  vatar tenglamalaridan foydalanib topamiz. Agar  $y_{\text{vatar}} = f(a) + \frac{x-a}{b-a}(f(b) - f(a))$  tenglamaga  $x = c$  va  $\frac{c-a}{b-a} = \lambda$  almashtirish kiritsak,  $cC_1 = f(a) + \lambda(f(b) - f(a)) = \lambda f(b) + (1 - \lambda)f(a)$  ni hosil qilamiz, bunda  $0 \leq \lambda \leq 1$  bo'ladi.

Shu kabi  $cC = f(s)$  ga  $\frac{c-a}{b-a} = \lambda$  bo'yicha  $c = \lambda b + (1 - \lambda)a$  topib qo'yilsa,  $cC = f(\lambda b + (1 - \lambda)a)$  bo'ladi. Agar topilgan natijalar  $cC \leq cC_1$  ga qo'yilsa, (4) tengsizlik hosil qilinadi.

$f'' < 0$  bo'lgan hol ham shunday isbotlanadi.  $\lambda = \frac{1}{2}$  bo'lgan xususiy hol uchun (4) bo'yicha

$$f\left(\frac{a+b}{2}\right) \leq \frac{f(a)+f(b)}{2} \quad (6)$$

ga ham ega bo'lamiz.

4-misol.  $\left(\frac{a+b}{2}\right)^5 \leq \frac{a^5+b^5}{2}$  ni isbot qilamiz, bunda  $a \geq 0$ ,  $b > 0$ .

Isbot. Bizda  $f(c) = f\left(\frac{a+b}{2}\right) = \left(\frac{a+b}{2}\right)^5$ ,  $\lambda = \frac{c-a}{b-a} = \frac{\frac{a+b}{2}-a}{b-a} = \frac{1}{2}$ ,

$f'' > 0$ . (6) munosabatdan foydalanamiz.  $f(a) = a^5$ ,  $f(b) = b^5$  bo'layotganidan, bular (6) ga qo'yilsa, berilgan tengsizlik hosil bo'ladi.



## Mashqlar

5.93. Tengsizliklarni isbot qiling:

1)  $\left(\frac{a+b}{2}\right)^4 \leq \frac{a^4+b^4}{2}$ ,  $a \geq 0$ ,  $b \geq 0$ ;



$$2) \left( \frac{a+\lambda b}{1+\lambda} \right)^2 \leq \frac{a^2+\lambda b^2}{1+\lambda}, \quad a \geq 0, \quad b \geq 0, \quad \forall \lambda \in [0; 1];$$

$$3) \sqrt[4]{\frac{a+\lambda b}{1+\lambda}} \geq \frac{\sqrt[4]{a+\lambda} \sqrt[4]{b}}{1+\lambda}, \quad a \geq 0, \quad b \geq 0, \quad \lambda \in [0; 1];$$

$$4) \left( \frac{a+b}{2} \right)^p \leq \frac{a^p+b^p}{2}, \quad a \geq 0, \quad b \geq 0, \quad p \geq 1;$$

$$5) a^8 + b^8 \geq \frac{1}{128}, \quad a \geq 0, \quad b \geq 0, \quad a + b = 1.$$

**8. Nyuton binomi.** (lot. *bi* – ikki, yunoncha *nomos* – qism, had). Isaak Nyuton (1643–1727) – buyuk ingliz olimi. Nyuton binomi formulasi Nyuton ijodidan ancha oldin, xususan, samarqandlik olimlar G‘iyosiddin Jamshid al-Koshiy, Ali bin Muhammad Qushchining asarlarida uchraydi.

$(a+x)$  binom o‘z-o‘ziga  $n$  marta ko‘paytirilgach, natijada

$$(a+x)^n = T_0 + T_1x + T_2x^2 + T_3x^3 + \dots + T_nx^n \quad (1)$$

ko‘phad hosil bo‘ladi. Tenglikning o‘ng qismini binom *yoyilmasi* deb ataymiz. Noma‘lum  $T_0, T_1, \dots, T_n$  larni topamiz. Shu maqsadda (1) tenglikka  $x=0$  ni qo‘yamiz,  $T_0 = a^n$  hosil bo‘ladi.  $T_1$  ni topish uchun (1) tenglikni differensiallaymiz:

$$((a+x)^n)' = n(a+x)^{n-1} \cdot (a+x)' = n(a+x)^{n-1},$$

$$(T_0 + T_1x + T_2x^2 + \dots + T_nx^n)' = T_1 + 2T_2x + \dots + nT_nx^{n-1},$$

yoki

$$T_1 + 2T_2x + \dots + nT_nx^{n-1} = n(a+x)^{n-1} \quad (2)$$

(2) tenglikka  $x=0$  qo‘yilsa,  $T_1 = \frac{n}{1} a^{n-1}$  hosil bo‘ladi.

$T_2$  ni topish uchun (2) tenglikni differensiallaymiz va hosil bo‘ladigan

$$2T_2 + 3 \cdot 2 \cdot T_3x + \dots + n(n-1) \cdot T_nx^{n-2} = n(n-1)(a+x)^{n-2}$$

tenglikka  $x=0$  ni qo‘yamiz. Natijada:  $T_2 = \frac{n(n-1)}{1 \cdot 2} a^{n-2}$ .

Shu kabi takror differensiallashlar va natijalarga  $x=0$  ni qo‘yishlardan so‘ng

$$T_3 = \frac{n(n-1)(n-2)}{1 \cdot 2 \cdot 3} a^{n-3}, \quad T_4 = \frac{n(n-1)(n-2)(n-3)}{1 \cdot 2 \cdot 3 \cdot 4} a^{n-4},$$

umuman,  $k$ -qadamdan so‘ng

$$T_k = \frac{n(n-1)\dots(n-(k-1))}{1 \cdot 2 \cdot \dots \cdot k} a^{n-k}$$

ni topamiz.  $a^{n-k}$  ning oldida turgan kasrni  $C_n^k$  orqali belgilaylik, u holda ifoda

$$T_k = C_n^k a^{n-k} \quad (3)$$

ko'rinishga keladi.  $C_n^k$  kasr son (1) binom yoyilmasining  $(k+1)$ -hadi koeffitsiyenti, qisqacha, *binomial koeffitsiyent* deyiladi. (1) munosabatni quyidagi ko'rinishda yozamiz:

$$(a+x)^n = C_n^0 a^n + C_n^1 a^{n-1} x + \dots + C_n^k a^{n-k} x^k + \dots + C_n^n x^n, \quad (4)$$

bunda  $C_n^0 = C_n^n = 1$  deb qabul qilinadi. (4) formula *Nyuton binomi formulasidan* iborat. Agar  $1 \cdot 2 \cdot 3 \cdot \dots \cdot n$  ko'paytma  $n!$  ( $n$ -faktorial) orqali almashtirilsa,  $C_n^k$  ni topish formulasi yanada ixcham ko'rinishga keladi:

$$C_n^k = \frac{n(n-1)\dots(n-k+1)(n-k)(n-k-1)\dots 3 \cdot 2 \cdot 1}{1 \cdot 2 \cdot \dots \cdot k \cdot (n-k)(n-k-1)\dots 2 \cdot 1} = \frac{n!}{k!(n-k)!}, \quad C_n^k = \frac{n!}{k!(n-k)!}. \quad (5)$$

Hisoblashlarda  $0! = 1$  deb qabul qilinadi.

Binomial koeffitsiyentlarning ayrim xossalari:

1) koeffitsiyentlarning yuqori indeksleri 0 dan  $n$  gacha o'zgarib boradi; yoyilmada jami  $n+1$  ta had bor. Ixtiyoriy  $(k+1)$ -hadi

$$C_n^k a^{n-k} x^k \quad (6)$$

ko'rinishga ega;

2) agar (4) formulaga  $a = x = 1$  qo'yilsa,

$$2^n = C_n^0 + C_n^1 + C_n^2 + \dots + C_n^n \quad (7)$$

hosil bo'ladi, ya'ni  $n$ -darajali binom yoyilmasidagi koeffitsiyentlar yig'indisi  $2^n$  ga teng;

3) agar (4) formulaga  $a = 1, x = -1$  qo'yilsa:

$$0 = C_n^0 - C_n^1 + C_n^2 - C_n^3 - \dots,$$

ya'ni  $C_n^0 + C_n^2 + C_n^4 + \dots = C_n^1 + C_n^3 + C_n^5 + \dots$ . Bunga qaraganda toq o'rinda turgan binomial koeffitsiyentlar yig'indisi juft o'rinda turgan koeffitsiyentlar yig'indisiga teng;

4) agar (5) formulada  $k$  o'rniga  $n-k$  qo'yilsa,

$$C_n^k = C_n^{n-k} \quad (8)$$

formula hosil bo'ladi;

$$5) C_{n-1}^{k-1} + C_{n-1}^k = \frac{(n-1)!}{(k-1)!(n-1-(k-1))!} + \frac{(n-1)!}{k!(n-1-k)!} = \\ = (n-1)! \frac{k+(n-k)}{k!(n-k)!} = \frac{n!}{k!(n-k)!} = C_n^k.$$

Demak,

$$C_{n-1}^{k-1} + C_{n-1}^k = C_n^k. \quad (9)$$

1 - misol.  $C_{1000}^{998} = C_{1000}^2 = \frac{1000 \cdot 999}{1 \cdot 2} = 499500.$

2 - misol.  $(a+x)^6$  binom darajasini yoyamiz.

Yechish. Bizda  $n=6$ , binomial koeffitsiyentlar soni yettita.

Ularni topamiz:

$$C_6^0 = 1, C_6^1 = \frac{6}{1} = 6, C_6^2 = \frac{6 \cdot 5}{1 \cdot 2} = 15, C_6^3 = \frac{6 \cdot 5 \cdot 4}{1 \cdot 2 \cdot 3} = 20,$$

$$C_6^4 = C_6^2 = 15, C_6^5 = C_6^1 = 6, C_6^6 = 1.$$

(4) formula bo'yicha:

$$(a+x)^6 = a^6 + 6a^5x + 15a^4x^2 + 20a^3x^3 + 15a^2x^4 + 6ax^5 + x^6.$$

3 - misol.  $(a-x)^6$  binom darajasi yoyilmasini topamiz.

Yechish. Masala 1-misolda  $x$  o'rniga  $-x$  ni qo'yish bilan hal qilinadi:

$$(a-x)^6 = a^6 - 6a^5x + 15a^4x^2 - 20a^3x^3 + 15a^2x^4 - 6ax^5 + x^6.$$

Shu misolni  $(a+x)$  binomni o'z-o'ziga olti marta ko'paytirish, so'ng ixchamlashtirishlarni bajarish orqali ham yechgan bo'lardik. Lekin bu ish nisbatan mushkul ekani tushunarli.

4 - misol.  $(a^{-2} + \sqrt{x})^5$  binom darajasini yoyamiz.

Yechish.  $n=5$ . (4) munosabatda  $a$  o'rniga  $a^{-2}$  ni,  $x$  o'rniga  $\sqrt{x}$  ni qo'yish kerak. Binomial koeffitsiyentlar:

$$C_5^0 = 1, C_5^1 = \frac{5}{1} = 5, C_5^2 = \frac{5 \cdot 4}{1 \cdot 2} = 10, C_5^3 = C_5^2 = 10,$$

$$C_5^4 = C_5^1 = 5, C_5^5 = 1.$$

U holda:

$$(a^{-2} + \sqrt{x})^5 = (a^{-2})^5 + 5(a^{-2})^4 \cdot \sqrt{x} + 10(a^{-2})^3 (\sqrt{x})^2 + \\ + 10(a^{-2})^2 (\sqrt{x})^3 + 5a^{-2} (\sqrt{x})^4 + (\sqrt{x})^5 = a^{-10} + 5a^{-8} \sqrt{x} + \\ + 10a^{-6}x + 10a^{-4}x\sqrt{x} + 5a^{-2}x^2 + x^2\sqrt{x}.$$



**5.94.** Hisoblang:

1)  $C_3^1 \cdot C_3^2, C_4^1, C_4^3, C_5^4, C_6^1, C_6^5, C_n^1, C_n^{n-2};$

2)  $C_{1000}^1 \cdot C_{1000}^1, C_{1000}^{995}, C_{1000}^{996}.$

**5.95.**  $C_{1000}^3 = C_{1000}^{997}$  bo'lishini tekshiring.

**5.96.** (4) formuladan foydalanib, binomlarni yoying:

1)  $(a + x)^4;$                       2)  $(3 - m)^4;$                       3)  $(x - 1)^5;$

4)  $(x + 2)^5;$                       5)  $(a - 36)^4;$                       6)  $\left(\frac{1}{3}a + 2\right)^6;$

7)  $(\sqrt{a} - 2)^6;$                       8)  $(\sqrt{m} - \sqrt{n})^3;$                       9)  $\left(x^{\frac{1}{3}} + y^{\frac{1}{2}}\right)^5;$

10)  $\left(\frac{1}{2} - 4x\right)^5;$                       11)  $(\sqrt{5} - \sqrt{6})^6;$                       12)  $(\sqrt{3} - 1)^7.$

**5.97.** 5.96- mashqda keltirilgan binomlar yoyilmalarida qanchadan had bor?

**5.98.** (4) formulani matematik induksiya metodi yordamida isbot qiling.

**5.99.** Hisoblang:

1)  $C_{10}^3 + C_{11}^3 + C_{12}^3;$  2)  $C_{10}^0 \cdot C_8^3 + C_{10}^1 \cdot C_8^2 + C_{10}^2 \cdot C_8^1 + C_{10}^3 \cdot C_8^0;$

3)  $(C_4^0)^2 + (C_4^1)^2 + (C_4^2)^2 + (C_4^3)^2 + (C_4^4)^2.$

**9. Nyuton binomidan taqribiy hisoblashlarda foydalanish.**

Bu haqda qisman ushbu darslikning 1-qismi, V bobida ma'lumot berilgan edi. Endi hisoblashlarni bajarishda oldingi bandlarda berilgan yangi ma'lumotlardan ham foydalanamiz.

$x^2$  son yetarlicha kichik bo'lganidan, u tashlangan va  $(1 + x)^2 = 1 + 2x + x^2$  bo'yicha  $(1 + x)^2 \approx 1 + 2x$  taqribiy formula tuzilgan bo'lsin. Vujudga keladigan chetlanish (formula xatoligi)  $\epsilon = x^2$  bo'ladi.  $\epsilon$  xatolik  $x$  ning kattaligiga bog'liq. Hisoblashlarda bu e'tiborga olinishi kerak. Masalan,  $x$  ning qanday qiymatlarida  $\epsilon$  xatolik 0,005 dan ortmasligini bilish talab qilinsin.  $\epsilon = x^2 \leq 0,005$  tengsizlikni yechish kerak bo'ladi. Undan  $|x| \leq 0,07$  ni topamiz.

Demak,  $|x|$  ning 0,07 dan kichik qiymatlarida formula beradigan xatolik 0,005 dan ortmaydi.

Shu kabi formula yordamida topiladigan taqribiy son xatoligi  $\varepsilon \leq 0,0005$  chegarasida bo'lishi uchun  $x^2 \leq 0,0005$ , ya'ni  $|x| \leq \sqrt{0,0005} \approx 0,022$  bo'lishi, aksincha, binomda  $|x| \leq 0,022$  bo'lsa,  $(1+x)^2 \approx 1+2x$  taqribiy formula bo'yicha topilgan natijadagi xatolik 0,0005 dan ortmaydi. Shu tartibda amalda ko'p ishlatiladigan  $(1+x)^3 \approx 1+3x$  va boshqa formulalarni tuzib olish mumkin (jadvalga qarang; ichki kataklarda  $|x|$  qiymatlari keltirilgan).

Formula	$\varepsilon = 0,005$	$\varepsilon = 0,0005$	$\varepsilon = 0,00005$
$(1+x)^2 \approx 1+2x$	0,07	0,022	0,007
$(1+x)^3 \approx 1+3x$	0,04	0,012	0,004
$\frac{1}{1+x} \approx 1-x$	0,06	0,022	0,007
$\sqrt{1+x} \approx 1 + \frac{1}{2}x$	0,19	0,062	0,020
$\sqrt[3]{1+x} \approx 1 + \frac{1}{3}x$	0,20	0,065	0,021

1 - misol.  $1,038^3$  ni hisoblaymiz.

Yechish.  $(1+x)^3 \approx 1+3x$  formula bo'yicha:

$$1,038^3 \approx 1 + 3 \cdot 0,038 = 0,114.$$

Bizda  $x = 0,038 < 0,04$ . Jadvaldan  $\varepsilon < 0,005$  bo'lishini o'qib olamiz. Demak,  $1,038^3 \approx 0,114$ ,  $\varepsilon < 0,005$ .

2 - misol.  $1,0018^8$  ni  $\varepsilon = 0,0001$  gacha aniqlikda hisoblaymiz.

Yechish. Nyuton binomi formulasidan foydalanaylik:

$$1,0018^8 = (1+0,0018)^8 = 1 + 8 \cdot 0,0018 + \frac{8 \cdot 7}{1 \cdot 2} \cdot 0,0018^2 + \dots + 0,0018^8.$$

Yoyilmada shunday hadni topishimiz kerakki, u va undan keyingi barcha hadlar birgalikda  $\varepsilon$  dan kichik bo'lsin. Ikkinchi hadning  $\varepsilon$  dan katta ekani uning yozuvidan ko'rinib turibdi. Uchinchi had:

$$\frac{8 \cdot 7}{1 \cdot 2} \cdot 0,0018^2 = 28 \cdot 0,0000324 \approx 0,000091 < 0,0001.$$

Keyingi hadlar yanada kichrayib boradi. Uchinchi va keyingi hadlarni tashlaymiz. Natijada:  $1,0018^8 \approx 1 + 8 \cdot 0,0018 = 1,0144$ .

Yuqorida keltirilgan misollarda natural ko'rsatkichli binom formulalaridan foydalanildi. Lekin bu formula istalgan haqiqiy

ko'rsatkichli daraja uchun bajariladi. Faqat  $|x| < |a|$  bo'lishi shart. Yoyilmada cheksiz ko'p qo'shiluvchilardan iborat yig'indi hosil bo'lishi mumkin. Yoyilmada qancha had qoldirilganda izlanayotgan natijada zarur aniqlikda bo'lishini bilish uchun qo'shimcha tekshirishlar bajarilishi zarur.

3 - misol.  $\sqrt[3]{0,98}$  ni  $\varepsilon = 0,001$  aniqlikda hisoblaymiz.

Yechish.  $\sqrt[3]{0,98} = \sqrt[3]{1 + (-0,02)} = (1 + (-0,02))^{1/3}$ , bunda

$n = \frac{1}{3}$ ,  $a = 1$ ,  $x = -0,02$  bo'lmoqda. Nyuton binomi formulasi bo'yicha:

$$\begin{aligned} (1 + (-0,02))^{1/3} &= 1 + \frac{1}{3} \cdot (-0,02) + \frac{\frac{1}{3} \cdot (\frac{1}{3} - 1)}{1 \cdot 2} \cdot (-0,02)^2 + \frac{\frac{1}{3} \cdot (\frac{1}{3} - 1) \cdot (\frac{1}{3} - 2)}{1 \cdot 2 \cdot 3} \cdot (-0,02)^3 + \dots \\ &= 1 - 0,006666... - 0,000444... - 0,0000444... - \dots \end{aligned}$$

Talab etilayotgan aniqlikni oldingi ikki had ta'minlay oladi.

Javob:  $\sqrt[3]{0,98} \approx 0,993$ .



## Mashqlar

**5.100.** Yuqorida keltirilgan jadvaldagi barcha formulalarning aniqligini tekshiring.

**5.101.**  $x$  ning kichik qiymatlari uchun

$$(1 + x)^n \approx 1 + nx + \frac{n(n-1)}{2} \cdot x^2$$

formulaning o'rinli bo'lishini tekshiring.

**5.102.** 1)  $(1 + 0,05)^6$ ; 2)  $1,003^4$ ; 3)  $0,995^7$ ; 4)  $1,0003^{0,8}$ ;

5)  $\sqrt[3]{1,005}$  ni 0,001; 0,0005; 0,0001 gacha aniqlikda hisoblang.

**10. Tenglamalarni taqribiy yechish (Vatarlar va urinmalar usullari).** Biz tenglamalarni taqribiy yechishning ikki usuli – ildiz yotgan oraliqni ketma-ket ikkiga bo'lish va al-Koshiy usuli bilan tanishmiz. Ularda  $[a; b]$  kesmada qaralayotgan  $f(x)$  funksiyaning uzluksiz, monoton bo'lishi va  $f(a) \cdot f(b) < 0$  tengsizlikning bajarilishi talab etiladi, chunki shu holdagina  $[a; b]$  da yagona ildiz mavjud bo'ladi. Shu shartlarning bajarilishi talab qilinadigan yana ikki muhim usul bilan tanishamiz.

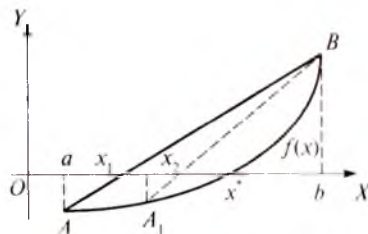

V.23- rasm.

1) Vatarlar usuli.  $f(x) = 0$  tenglamaning shu oraliqda yotgan  $x^*$  ildizini  $\varepsilon$  aniqlikda topish kerak bo'lsin.  $A(a; f(a))$  va  $B(b; f(b))$  nuqtalardan o'tkazilgan  $AB$  vatar  $Ox$  o'qini  $x_1$  nuqtada kessin,  $y_1 = 0$  (V.23-rasm).

$a$  nuqtada  $f(a) \cdot f''(a) < 0$

bo'lsa,  $x_0 = a$  va  $x_1$  nuqtalar izlanayotgan  $x^*$  ildizga boshlang'ich va birinchi yaqinlashish bo'ladi (aks holda,  $f(b) \cdot f''(b) < 0$  bo'lsa,  $x_0 = b$ ,  $x_1$  lar yaqinlashish bo'ladi). Agar  $\varepsilon \leq |x_1 - x_0|$  bo'lsa, masala hal qilindi va  $x^* \approx x_1$  deb qabul qilinadi. Aks holda shu kabi hisoblashlar  $[x_1; b]$  kesma va  $A_1B$  vatarga nisbatan takrorlanadi va hokazo.  $x_1$  yaqinlashishni aniqlash uchun  $AB$  vatarning  $y = f(a) + \frac{f(b)-f(a)}{b-a} \cdot (x-a)$  tenglamasiga  $x = x_1$ ,  $y = 0$  qo'yilib,  $x_1$  topiladi:

$$x_1 = a - \frac{b-a}{f(b)-f(a)} \cdot f(a). \quad (1)$$

Shu kabi,  $x_2$  yaqinlashishni topishda (1) dagi  $a$  o'rniga  $x_1$  qo'yiladi:

$$x_2 = x_1 - \frac{b-x_1}{f(b)-f(x_1)} \cdot f(x_1)$$

va hokazo, har qaysi  $x_k$  yaqinlashish oldin topilgan  $x_{k-1}$  bo'yicha aniqlanadi:

$$x_k = x_{k-1} - \frac{b-x_{k-1}}{f(b)-f(x_{k-1})} \cdot f(x_{k-1}). \quad (2)$$

Bu jarayonda  $B$  nuqta qo'zg'almas bo'lishini,  $x_k$  yaqinlashishlar  $x^*$  aniqlik yechimga quyi tomondan yaqinlashib borishini ko'ramiz. Agar  $f(b) \cdot f''(b) < 0$  bo'lsa,  $A$  nuqta qo'zg'almas bo'ladi va  $x^*$  ga yaqinlashishlar

$$x_k = x_{k-1} - \frac{x_{k-1}-a}{f(x_{k-1})-f(a)} \cdot f(x_{k-1}) \quad (3)$$

munosabat bo'yicha aniqlanadi. Bu holda  $x_k$  yaqinlashishlar  $x^*$  ga o'ng tomondan yaqinlashadi.

1 - misol.  $x^4 - 5x^2 + 8x - 8 = 0$  tenglamani  $\varepsilon = 0,0001$  gacha aniqlikda yechamiz.



Yechish. Ixtiyoriy tartibda  $a = -3$ ,  $b = -2,9$  nuqtalarni tanlaymiz. Ularda  $f(-2,9) = -2,52... < 0$ ,  $f(-3) = 4 > 0$ , demak,  $f(-2,9) \cdot f(-3) < 0$  bo'lishini ko'ramiz. Funktsiya  $(-3; -2,9)$  intervalda uzluksiz, monoton, demak, yagona ildizga ega. Uni topishda vatarlar usuli qo'llanilganda, oldin  $x_0$  boshlang'ich yaqinlashish aniqlanadi.

$$f'' = (4x^3 - 5x + 8)' = -12x^2 - 5, \quad f''(-2,9) > 0, \quad f''(-3) > 0;$$

$$f(-2,9) \cdot f''(-2,9) < 0.$$

Demak,  $x_0 = -2,9$ . U holda:

$$x_1 = -2,9 - \frac{-2,9 - (-3)}{-2,5219 - 4} \cdot (-2,5219) \approx -2,93867, \quad f(x_1) \approx -0,11166.$$

$|x_1 - x_0| = 0,0386 > \varepsilon$ , ya'ni hali talab qilingan aniqlik ta'minlangan emas va hisoblashlar davom ettirilishi kerak:

$$x_2 = -2,93867 - \frac{-2,93867 - (-3)}{-0,11166 - 4} \cdot (-0,11166) \approx -2,94033, \quad f(x_2) \approx -0,0473.$$

Lekin  $|x_2 - x_1| = 0,0017 > \varepsilon$ ; hisoblashlar yana davom ettiriladi:

$$x_3 = -2,94033 - \frac{-2,94033 - (-3)}{-0,00473 - 4} \cdot (-0,00473) \approx -2,94040,$$

$$|x_3 - x_2| = |-2,94040 - (-2,94033)| = 0,00007 < \varepsilon.$$

Talab qilingan aniqlikka erishildi. J a v o b :  $x^* \approx -2,94040$ .

2) Urinmalar usuli. Agar  $f(x)$  funksiya  $[a; b]$  kesmada uzluksiz, differensiallanuvchi va  $f(a) \cdot f(b) < 0$  bo'lsa, kesmaning uchlaridan birida  $f(x)$  grafigiga o'tkaziladigan urinma  $OX$  o'qini albatta kesadi (V.24-rasm). Kesishish nuqtasi  $f(x) = 0$  tenglama

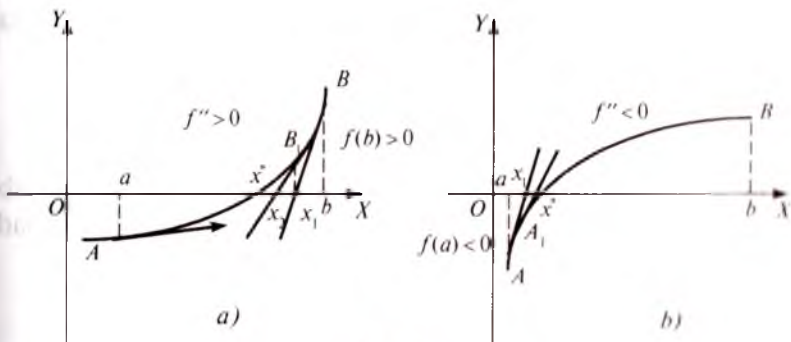

V.24-rasm.



ildizining biror yaqinlashishini beradi. Boshlang'ich yaqinlashish sifatida  $[a; b]$  kesmaning shunday uchi (V.24-*a* rasmda  $B$  nuqta, V.24-*b* chizmada  $A$  nuqta) tanlanadiki, unda  $f$  funksiya va uning  $f''$  hosilasi bir xil ishoraga ega bo'lsin. Undan o'tkaziladigan urinma  $OX$  o'qini albatta kesadi va  $x_1$  yaqinlashishini beradi. Bu holda boshqa uchidan o'tkaziladigan urinma  $OX$  o'qini  $[a; b]$  kesmada kesmasligi mumkin. Barcha  $x_k$  yaqinlashishlar uchun yuqoridagi kabi rekurrent formulani tuzish maqsadida  $A(a; f(a))$  yoki  $B(b; f(b))$  dan o'tuvchi urinma tenglamasiga  $y = 0$  qo'yiladi. Jumladan,  $A$  nuqtadan o'tuvchi urinmaning  $y = f(a) + f'(a)(x - a)$  tenglamasi bo'yicha

$$0 = f(a) + f'(a)(x - a),$$

yoki

$$x = a - \frac{f(a)}{f'(a)} \quad (4)$$

rekurrent munosabatni,  $B$  nuqta bo'yicha esa

$$x = b - \frac{f(b)}{f'(b)} \quad (5)$$

ni hosil qilamiz. Agar boshlang'ich yaqinlashish sifatida  $x_0 = a$  yoki  $x_0 = b$  tanlangan bo'lsa, qolgan  $x_k$  yaqinlashishlar ushbu rekurrent formula bo'yicha topiladi:

$$x_k = x_{k-1} - \frac{f(x_{k-1})}{f'(x_{k-1})}. \quad (6)$$

2 - m i s o l.  $x^4 - 5x^2 + 8x - 8 = 0$  tenglamani urinmalar usulini qo'llab yechamiz. 1-misolda ko'rsatilganidek,  $\varepsilon = 0,0001$  bo'lsin.

Y e c h i s h.  $f(x)$  funksiya  $[-3; -2,9]$  kesmada differensiallanadi. Unda

$$f'' = (x^4 - 5x^2 + 8x - 8)'' = (4x^3 - 10x + 8)' = 12x^2 - 10 > 0, \\ f'(-3) > 0, f'(-2,9) < 0.$$

Bu kesmada  $f''$  va  $f'(-3)$  larning ishoralari bir xil musbat. Boshlang'ich yaqinlashish sifatida  $x_0 = -3$  ni olamiz. (6) formuladan foydalanamiz:

$$f(-3) = (-3)^4 - 5 \cdot (-3)^2 + 8 \cdot (-3) - 8 = 4, \\ f'(-3) = 4 \cdot (-3)^3 - 10 \cdot (-3) + 8 = -70.$$

U holda

$$x_1 = -3 - \frac{4}{-70} = -2,942857... \approx -2,94286,$$

$$\varepsilon_1 = |-2,94286 - (-3)| > \varepsilon,$$

hisoblashlar davom ettirilishi kerak:

$$f(x_1) \approx 0,15777, f'(x_1) \approx -64,5168; x_2 = -2,94041,$$

$$\varepsilon_2 = |-2,94041 - (-2,94286)| = 0,00044 > \varepsilon;$$

$$f(x_2) \approx 0,0002809 \approx 0,00028, f'(x_2) \approx -64,2873,$$

$$x_3 \approx -2,94041; \varepsilon_3 = |x_3 - x_2| \approx 0 < \varepsilon$$

bo'lmogda. Zarur aniqlikka erishildi, hisoblashlar to'xtatiladi. Izlanayotgan ildiz:  $-2,9404$ .



### Mashqlar

**5.103.**  $f(x) = 0$  tenglamaning ildizlarini 0,01 aniqlikda toping:

1)  $2x^3 - 6x + 5 = 0$ ; 2)  $x^4 + 4x - 1 = 0$ ; 3)  $x^4 + x^2 + 6x - 8 = 0$ .

**5.104.** Ildizlarni 0,0001 aniqlikda toping:

1)  $\sqrt{139}$ ; 2)  $\sqrt[3]{231}$ ; 3)  $\sqrt[3]{34}$ ; 4)  $\sqrt[4]{56,4}$ ; 5)  $\sqrt[5]{544}$ .

## 1-§. Aniqmas integral

**1. Integrallash amali. Boshlang'ich funksiya.** Biz  $F(x)$  funksiyaning  $F'(x)$  hosilasini topish zarur bo'lsa, funksiyalarni differensiallash qoidalaridan foydalanganmiz. Agar hosila  $x$  argumentning funksiyasi bo'lib, uni  $f(x)$  orqali belgilasak,  $F'(x) = f(x)$  bo'ladi va  $F(x)$  funksiya differensialini  $dF(x) = F'(x)dx$  yoki  $dF(x) = f(x)dx$  ko'rinishda yozish mumkin bo'ladi. Aksincha, funksiyaning biror  $X$  oraliqda berilgan  $f(x)$  hosilasi bo'yicha shu oraliqda aniqlangan  $F(x)$  funksiyaning o'zini topish talab etilsa,  $f(x)$  funksiyaning *integrallash* amali bilan, ya'ni integrallash nomi bilan ataluvchi maxsus qoidalar va formulalardan foydalaniladi. Izlanayotgan  $F(x)$  funksiya  $f(x)$  uchun boshlang'ich funksiya vazifasini o'taydi. Integrallash amali  $\int$  belgisi bilan belgilanadi (lotincha *integrare* – tiklash).

Shunday qilib, biror  $X$  oraliqdagi barcha  $x$  lar uchun  $F'(x) = f(x)$  o'rinli bo'lsa,  $F(x)$  funksiya shu oraliqda  $f(x)$  funksiyaning *boshlang'ich funksiyasi* deyiladi.

Matematikaga integral atamasini shveysariyalik matematik Iogann Bernulli (1667–1748) kiritgan va integral hisobdan birinchi sistematik kurs tayyorlagan. Uning shogirdi Peterburg fanlar akademiyasining haqiqiy a'zosi Leonard Eyler (1707–1783) integrallashni  $\int f(x)dx$  belgisi orqali belgilagan. Hozirgi zamon belgilashlarini esa fransuz matematigi J. Furiye (1768–1860) kiritgan.

**1 - misol.** Agar  $F'(x) = f(x) = 4x^3$ ,  $x \in R$  bo'lsa, boshlang'ich funksiya  $F(x) = x^4$  va umuman,  $F(x) + C = x^4 + C$  bo'ladi, bunda  $C$  – ixtiyoriy o'zgarmas son. Chunki  $(F(x) + C)' = (x^4 + C)' = 4x^3 + 0 = 4x^3$ .

Differensiallash va integrallash amallari o'zaro teskari amallardir.  $F(x)$  funksiyaning integrallash  $\int f(x)dx = F(x) + C$  ko'rinishda yoziladi. Xususan, yuqoridagi misol bo'yicha biz

$\int 4x^3 dx = x^4 + C$  ga ega bo'lamiz, bunda  $C = \text{const}$ .

**Teorema.** Agar  $f(x)$  funksiya  $X$  oraliqda  $F(x)$  boshlang'ich funksiyaga ega bo'lsa,  $F(x) + C$  funksiya ham  $f(x)$  uchun boshlang'ich funksiya bo'ladi, bunda  $C$  — ixtiyoriy o'zgarmas son.  $X$  da  $f(x)$  funksiya boshqa ko'rinishdagi boshlang'ich funksiyaga ega emas.

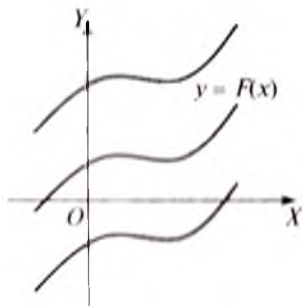

VI.1-rasm.

**Isbot.** Barcha  $x \in X$  lar uchun  $F'(x) = f(x)$ , chunki shu oraliqda  $F(x)$  funksiya  $f(x)$  funksiya uchun boshlang'ich funksiya. Lekin ixtiyoriy  $C$  haqiqiy son uchun  $(F(x) + C)' = f(x)$ . Demak,

$\int f(x) dx = F(x) + C$ . Shu bilan birga  $f(x)$  funksiya  $X$  da boshqa ko'rinishdagi boshlang'ich funksiyaga ega bo'la olmaydi. Haqiqatan, biror  $\Phi(x)$  ham  $f(x)$  ning boshlang'ich funksiyasi bo'lsin, deb faraz qilaylik:  $\Phi'(x) = f(x)$ . U holda har bir  $x \in X$  uchun  $\varphi'(x) = \Phi'(x) - F'(x) = 0$  bo'ladi.  $\varphi'(x) = 0$  bo'lgani uchun  $\varphi(x) = C$  bo'ladi. Demak,  $\Phi(x) - F(x) = C$ . Bundan  $\Phi(x) = F(x) + C$ , ya'ni ixtiyoriy boshlang'ich funksiya  $F(x) + C$  ko'rinishiga ega bo'ladi.

Shunday qilib,  $f(x)$  funksiyaning barcha  $F(x) + C$  boshlang'ich funksiyalarini topish uchun avval ulardan birini, masalan,  $F(x)$  ni topish, so'ngra unga istalgan  $C \in R$  o'zgarmas sonni qo'shish kifoya.  $C$  ixtiyoriy bo'lgani uchun funksiyaning boshlang'ich funksiyalari cheksiz ko'p bo'ladi.

Qo'shiluvchi  $C$  son *integrallash doimiysi*,  $F(x) + C$  boshlang'ich funksiyalar to'plami  $f(x)$  funksiyaning  $\int f(x) dx$  *aniqmas integrali* deyiladi.

Berilgan  $f(x)$  funksiyaning barcha boshlang'ich funksiyalari grafiklari  $y = F(x)$  funksiya grafigini  $OY$  o'qi bo'yicha  $C$  qadar siljitishdan hosil qilinadi va shu yo'l bilan boshlang'ich funksiya grafigini berilgan nuqta orqali o'tishiga erishiladi (VI.1-rasm).

**2-misol.**  $y = x^2$  funksiyaning grafigi  $A(1; 2)$  nuqtadan o'tuvchi boshlang'ich funksiyasini topamiz.

**Yechish.**  $f(x) = x^2$  funksiya uchun  $F(x) = \frac{x^3}{3} + C$ , chunki  $F'(x) = x^2$ . Shunday  $C$  sonni topamizki,  $y = \frac{x^3}{3}$  funksiyaning

grafigi  $A(1; 2)$  nuqta orqali o'tsin. Oxirgi tenglikka  $x = 1; y = 2$  qiymatlarni qo'yib,  $2 = \frac{1}{3} + C$  ni hosil qilamiz. Bundan  $C = \frac{5}{3}$ .

Demak,  $F(x) = \frac{x^3}{3} + \frac{5}{3}$ .

Aniqmas integralning xossalari:

1) Ixtiyoriy  $C$  son uchun ushbu tenglik o'rinli:

$$d\left(\int f(x)dx\right) = f(x)dx. \quad (1)$$

Haqiqatan,  $\int f(x)dx = F(x) + C$  va  $F'(x) = f(x)$  bo'lganligidan:

$$d\left(\int f(x)dx\right) = (F(x) + C)'dx = F'(x)dx = f(x)dx.$$

3 - misol.  $\int \cos x dx = \sin x + C$  bo'ladi. Chunki  $(\sin x + C)' = \cos x$  va  $d\left(\int \cos x dx\right) = d(\sin x + C) = d(\sin x) = \cos x dx$ .

2) Ushbu tenglik o'rinli:

$$\int F'(x)dx = F(x) + C. \quad (2)$$

Chunki  $\int F'(x)dx = \int f(x)dx = F(x) + C$ .

4 - misol.  $\int \cos x dx = \int (\sin x)' dx = \sin x + C$ .

3) Ushbu tenglik o'rinli:

$$\int (\varphi(x) + \psi(x))dx = \int \varphi(x)dx + \int \psi(x)dx. \quad (3)$$

Haqiqatan,  $\int \varphi(x)dx = \Phi(x) + C_1$  va  $\int \psi(x)dx = \Psi(x) + C_2$  bo'lsin. U holda  $\Phi'(x) = \varphi(x)$ ,  $\Psi'(x) = \psi(x)$  va shunga ko'ra

$$\begin{aligned} \int (\varphi(x) + \psi(x))dx &= \int (\Phi'(x) + \Psi'(x))dx = \int (\Phi(x) + \Psi(x))'dx = \\ &= \Phi(x) + \Psi(x) + C = \int \varphi(x)dx + \int \psi(x)dx, \end{aligned}$$

bunda  $C = C_1 + C_2$ .

4) O'zgarmas ko'paytuvchini integral belgisi ostidan chiqarish mumkin:

$$\int kf(x)dx = k \int f(x)dx, \quad k - \text{o'zgarmas son.} \quad (4)$$

Haqiqatan,  $F'(x) = f(x)$  va  $(kF(x))' = kF'(x) = kf(x)$  bo'lganidan,

$$\int kf(x)dx = kF(x) + C = k \int f(x)dx.$$

Jumladan, 2 va 4-xossalar va  $\alpha \neq -1$  uchun  $(x^{\alpha+1})' = (\alpha+1)x^{\alpha}$  bo'yicha darajali funksiya uchun

$$\int x^{\alpha} dx = \frac{1}{\alpha+1} \int (\alpha+1)x^{\alpha} dx = \frac{x^{\alpha+1}}{\alpha+1} + C \quad (5)$$

hosil qilinadi.

5-misol.  $I = \int (4x^3 - 9x^2 + 6x - 8)dx$  ni hisoblaymiz.

Yechish. 3 va 4-xossalarga asosan:

$$I = 4 \int x^3 dx - 9 \int x^2 dx + 6 \int x dx - 8 \int dx,$$

(5) formula bo'yicha:

$$\int x^3 dx = \frac{x^4}{4} + C, \quad \int x^2 dx = \frac{x^3}{3} + C, \quad \int x dx = \frac{x^2}{2} + C, \quad \int dx = x + C.$$

$$I = 4 \cdot \frac{x^4}{4} - 9 \cdot \frac{x^3}{3} + 6 \cdot \frac{x^2}{2} - 8x + C = x^4 - 3x^3 + 3x^2 - 8x + C.$$

Biz  $C$  ni bir marta yozdik, chunki o'zgarmaslar yig'indisini bitta o'zgarma bilan almashtirish mumkin.

6-misol.  $I = \int \left( x\sqrt[4]{x} - \frac{8}{x^3} \right) dx$  integralni hisoblaymiz.

$$\text{Yechish. } I = \int \left( x^{\frac{5}{4}} - 8x^{-3} \right) dx = \frac{x^{\frac{5}{4}+1}}{\frac{5}{4}+1} - 8 \cdot \frac{x^{-3+1}}{-3+1} + C =$$

$$= \frac{4x^2\sqrt[4]{x}}{9} + 4x^{-2} + C.$$

## Mashqlar

**6.1.**  $F(x)$  funksiyaning  $f(x)$  funksiya uchun boshlang'ich funksiya bo'lishini isbot qiling:

1)  $F(x) = \frac{x^6}{6} + 2 \cos 3x, f(x) = x^5 - 6 \sin 3x;$

2)  $F(x) = \arctg^2 2x, f(x) = \frac{4 \arctg 2x}{1+4x^2};$

$$3) F(x) = \operatorname{tg}^3 3x - \sin 5x, f(x) = \frac{9 \operatorname{tg}^2 3x}{\cos^2 3x} - 5 \cos 5x;$$

$$4) F(x) = \arcsin(x^8), f(x) = \frac{8x^7}{\sqrt{1-x^{16}}};$$

$$5) F(x) = \sin \sqrt{x} - \cos(x^2), f(x) = \frac{\cos \sqrt{x}}{2\sqrt{x}} + 2x \sin(x^2);$$

$$6) F(x) = x^5 \cos x - \frac{8}{\sin x}, f(x) = 5x^4 \cos x - x^5 \sin x + \frac{8 \cos x}{\sin^2 x}.$$

**6.2. Integrallarni hisoblang:**

$$1) \int x^6 dx;$$

$$2) \int x^2 \sqrt[3]{x} dx;$$

$$3) \int \frac{x^4 - 2x^2 - \sqrt{x} + 1}{x^2 \sqrt{x}} dx;$$

$$4) \int \frac{x^6 - 9}{x^3 + 3} dx.$$

**6.3.  $f(x)$  funksiya uchun  $A(x_0; y_0)$  nuqtadan o'tuvchi boshlang'ich funksiyani toping:**

$$1) f(x) = 3x - 1, A(1, 3);$$

$$2) f(x) = 4x + 3, A(1, 2);$$

$$3) f(x) = \sqrt{x}, A(9, 10).$$

**2. Integrallash formulari.** Funksiyalarni integrallashda ularning differensiallash natijalariga asoslaniladi. Differensiallashning har bir  $F'(x) = f(x)$  formulasidan integrallashning unga mos  $\int f(x) dx = F(x) + C$  formulasi hosil bo'ladi. Integrallash jadvalini keltiramiz:

No	$\int f(x) dx = F(x) + C$	$F'(x) = f(x)$
1	$\int x^\alpha dx = \frac{x^{\alpha+1}}{\alpha+1} + C, \alpha \neq -1$	$\left(\frac{x^{\alpha+1}}{\alpha+1} + C\right)' = \frac{\alpha+1}{\alpha+1} x^\alpha = x^\alpha, \alpha \neq -1$
2	$\int \cos x dx = \sin x + C$	$(\sin x + C)' = \cos x$
3	$\int \sin x dx = -\cos x + C$	$(-\cos x + C)' = -(-\sin x) + 0 = \sin x$
4	$\int \frac{dx}{\cos^2 x} = \operatorname{tg} x + C$	$(\operatorname{tg} x + C)' = \frac{1}{\cos^2 x}, x \neq \frac{\pi}{2} + 2k\pi, k \in \mathbb{Z}$
5	$\int \frac{dx}{\sin^2 x} = -\operatorname{ctg} x + C$	$(-\operatorname{ctg} x + C)' = -\left(-\frac{1}{\sin^2 x}\right) = \frac{1}{\sin^2 x}, x \neq \pi k, k \in \mathbb{Z}$
6	$\int \frac{dx}{\sqrt{1-x^2}} = \arcsin x + C$	$(\arcsin x + C)' = \frac{1}{\sqrt{1-x^2}},  x  < 1$

7	$\int \frac{dx}{1+x^2} = \text{arctg}x + C$	$(\text{arctg}x + C)' = \frac{1}{1+x^2}$
8	$\int \sqrt{a^2 - x^2} dx = \frac{x}{2} \sqrt{a^2 - x^2} + \frac{a^2}{2} \arcsin \frac{x}{a} + C$	$\left( \frac{x}{2} \sqrt{a^2 - x^2} + \frac{a^2}{2} \arcsin \frac{x}{a} + C \right)' = \sqrt{a^2 - x^2},  a  \geq  x $
9	$\int e^x dx = e^x + C$	$(e^x + C)' = e^x$
10	$\int a^x dx = \frac{a^x}{\ln a} + C$	$(a^x + C)' = a^x \ln a$
11	$\int \frac{dx}{x} = \ln x  + C$	$x > 0$ da $\int \frac{dx}{x} = \ln x + C, (\ln x + C)' = \frac{1}{x}$ ; $x < 0$ da $\int \frac{dx}{x} = \ln(-x) + C$ $(\ln(-x) + C)' = \frac{1}{x} \cdot (-1) = \frac{1}{x}$

1 - misol.  $I = \int \frac{2(1+x^2) - \sqrt{1-x^2}}{(1+x^2)\sqrt{1-x^2}} dx$  integralni hisoblaymiz,  $|x| < 1$ .

**Yechish.** Dastlab integral ostidagi ifodani soddalashtiramiz:

$$\begin{aligned} f(x) &= \frac{2(1+x^2) - \sqrt{1-x^2}}{(1+x^2)\sqrt{1-x^2}} = \frac{2(1+x^2)}{(1+x^2)\sqrt{1-x^2}} - \frac{\sqrt{1-x^2}}{(1+x^2)\sqrt{1-x^2}} = \\ &= \frac{2}{\sqrt{1-x^2}} - \frac{1}{1+x^2}. \end{aligned}$$

Jadvaldagi 6, 7- formulalar bo'yicha:

$$I = 2 \int \frac{dx}{\sqrt{1-x^2}} - \int \frac{dx}{1+x^2} = 2 \arcsin x - \text{arctg}x + C.$$

2 - misol.  $I = \int \left( \frac{5}{\sin^2 x} + \frac{6}{\cos^2 x} \right) dx$  ni hisoblaymiz, bunda  $x \neq \pi k, x \neq \frac{\pi}{2} + 2\pi k, k \in \mathbb{Z}$ .

**Yechish.** Jadvaldagi 5, 4 - formulalar bo'yicha:

$$I = 5 \int \frac{dx}{\sin^2 x} + 6 \int \frac{dx}{\cos^2 x} = -5 \text{ctg}x + 6 \text{tg}x + C.$$



3 - misol.  $I = \int (7 \cos x - 6 \sin x) dx$  ni hisoblaymiz:

Yechish. Jadvaldagi 2, 3 - formulalar bo'yicha:

$$I = 7 \int \cos x dx - 6 \int \sin x dx = 7 \sin x + 6 \cos x + C.$$

4 - misol.  $\int \frac{dx}{a^2 + x^2} = \frac{1}{a} \int \frac{d\left(\frac{x}{a}\right)}{1 + \left(\frac{x}{a}\right)^2} = \frac{1}{a} \int \frac{du}{1 + u^2} = \frac{1}{a} \arctg u + C =$

$= \frac{1}{a} \arctg \frac{x}{a} + C$ , ( $u = \frac{x}{a}$  almashtirish va jadvaldagi 7- formuladan foydalandik).

5 - misol.  $\int e^{3x} dx$  ni hisoblaymiz.

Yechish.  $\int e^{3x} dx = \frac{1}{3} \int e^{3x} d(3x) = \frac{1}{3} \cdot e^{3x} + C.$

6 - misol.  $\int \frac{dx}{x+2}$  ( $x \neq -2$ ) ni hisoblaymiz.

Yechish.  $\int \frac{dx}{x+2} = \int \frac{d(x+2)}{x+2} = \ln(x+2) + C.$



## Mashqlar

6.4. Integrallarni hisoblang:

1)  $\int (4\sqrt[3]{x} + 2x) dx$ ;    2)  $\int (7 \cos x - \frac{10}{\sin^2 x}) dx$ ,  $x \neq \pi k$ ,  $k \in Z$ ;

3)  $\int \left( \frac{3}{\sqrt{1-x^2}} - \frac{4}{1+x^2} \right) dx$ ,  $|x| < 1$ ;    4)  $\int \left( 4 \sin x - \frac{3}{1+x^2} \right) dx$ ;

5)  $\int \left( \frac{3}{\cos^2 x} - \frac{2}{\sqrt{1-x^2}} \right) dx$ ,  $|x| < 1$ ;    6)  $\int \frac{\sin^3 x + 1}{\sin^2 x} dx$ ,  $x \neq \pi k$ ,  $k \in Z$ ;

7)  $\int \frac{(x^5 - 1) dx}{x^2 + 1}$ ;    8)  $\int \frac{x^4 - x^3 + x - 1}{x - 1} dx$ ,  $x \neq 1$ ;    9)  $\int \operatorname{tg}^2 3x dx$ .

6.5.  $y = e^{-3x}$  funksiya  $y' = -3e^{-3x}$  tenglikni qanoatlantiradimi?

6.6.  $y = e^{x/3}$  funksiya  $y' = \frac{1}{3}y$  tenglamani qanoatlantirishini isbot qiling.

### 6.7. Integrallarni hisoblang:

1)  $\int 3^x dx$ ; 2)  $\int e^{2x} dx$ ; 3)  $\int e^{-5x} dx$ ; 4)  $\int e^x \cos(e^x) dx$ .

### 6.8. Integrallarni hisoblang:

1)  $\int \frac{dx}{x+6}$ ; 2)  $\int \frac{dx}{6x-7}$ ; 3)  $\int \frac{x^4 dx}{1+x^5}$ ;

4)  $\int \frac{x^3 dx}{1+x^2}$ ; 5)  $\int \operatorname{tg} 5x dx$ ; 6)  $\int \operatorname{tg}(4x-2) dx$ ;

7)  $\int \frac{dx}{(1+x^2) \operatorname{arctg} x}$ ; 8)  $\int \frac{dx}{\sqrt{1+x^2} \operatorname{arctg} x}$ .

**3. O'zgaruvchini almashtirish usuli.** Ushbu usul (boshqacha aytganda, o'rniga qo'yish usuli) jadvalda ko'rsatilmagan integrallarni jadvaldagi biror ko'rinishga keltirib hisoblash maqsadida qo'llaniladi. Usulning asosida murakkab funktsiyani differensiallash qoidasi yotadi:  $F(\varphi(t))$  funktsiya berilgan va  $x = \varphi(t)$  almashtirish kiritilgan bo'lsin. U holda:

$$(F(\varphi(t)))' = F'(x)\varphi'(t) = f(x)\varphi'(t) = f(\varphi(t))\varphi'(t) \text{ va}$$

$$\int f(x) dx = F(x) + C$$

bo'lganidan quyidagiga ega bo'lamiz:

$$\int f(\varphi(t))\varphi'(t) dt = F(\varphi(t)) + C \quad (1)$$

yoki

$$\int f(\varphi(t)) d\varphi(t) = F(\varphi(t)) + C. \quad (2)$$

Demak,  $F(\varphi(t))$  funktsiya  $f(\varphi(t))\varphi'(t)$  funktsiyaning boshlang'ich funktsiyasi ekan. Xususan,  $\varphi(t) = kt + b$  bo'lsin. U holda:  $\varphi'(t) = k$  yoki  $d\varphi(t) = k dt$  va (2) bo'yicha

$$\int f(kt + b) k dt = F(kt + b) + C$$

yoki

$$\int f(kt + b) dt = \frac{1}{k} \cdot F(kt + b) + C. \quad (3)$$

**I - m i s o l.**  $I_1 = \int \sin(10x + 8) dx$  va  $I_2 = \int (7x - 8)^4 dx$  integrallarni hisoblaymiz.

Yechish. Integrallash jadvalidagi 1 va 3- formulalarga muvofiq:

$$I_1 = -\frac{1}{10} \cos(10x+8) + C, \quad I_2 = \frac{1}{5.7} (7x-8)^5 + C = \frac{1}{35} (7x-8)^5.$$

2- misol.  $I = \int x^3 \cos(x^4) dx$  integralni hisoblaymiz.

Yechish.  $(x^4)' = 4x^3$  bo'lganligidan,  $x^4 = t$  almashtirish kiritamiz. U holda  $d(x^4) = dt$  yoki  $4x^3 dx = dt$  va bundan  $x^3 dx = \frac{dt}{4}$ , u holda

$$I = \frac{1}{4} \int \cos t dt = \frac{1}{4} \sin t + C = \frac{1}{4} \sin(x^4) + C.$$

3- misol.  $I = \int \cos^3 x \sin x dx$  integralni hisoblaymiz.

Yechish.  $(\cos x)' = -\sin x$  bo'lganligidan  $\cos x = t$  almashtirish kiritamiz. U holda  $dt = d(\cos x) = (\cos x)' dx = -\sin x dx$  va

$$I = \int t^3 (-dt) = -\frac{t^4}{4} + C = -\frac{\cos^4 x}{4} + C.$$

4- misol.  $\int \frac{\sin x dx}{\cos^4 x}$  integralni hisoblaymiz ( $x \neq \frac{\pi}{2} + k\pi, k \in \mathbb{Z}$ ).

Yechish.  $\sin x dx = -d(\cos x)$ ;  $\cos x = t$  almashtirish kiritamiz.

$$\int \frac{\sin x dx}{\cos^4 x} = -\int \frac{d(\cos x)}{\cos^4 x} = -\int \frac{dt}{t^4} = -\int t^{-4} dt = -\frac{t^{-3}}{-3} + C = \frac{1}{3} \cdot \frac{1}{\cos^3 x} + C.$$

5- misol.  $\int \sqrt{a^2 - x^2} dx$  ni hisoblaymiz, bunda  $a > x$ .

Yechish.  $x = \varphi(t) = a \sin t$  bo'lsin, bunda  $t \in \left[-\frac{\pi}{2}; \frac{\pi}{2}\right]$ . U holda:

$$\varphi'(t) = a \cos t, \quad dx = a \cos t dt \text{ va}$$

$$\int \sqrt{a^2 - x^2} dx = a^2 \int \sqrt{1 - \sin^2 t} \cos t dt = a^2 \int \cos^2 t dt.$$

Lekin  $\cos^2 t = \frac{1 + \cos 2t}{2}$ . Shunga ko'ra

$$\begin{aligned} \int \sqrt{a^2 - x^2} dx &= \frac{a^2}{2} \int (1 + \cos 2t) dt = \frac{a^2}{2} \int dt + \frac{a^2}{2} \int \cos 2t dt = \\ &= \frac{a^2 t}{2} + \frac{a^2 \sin 2t}{2 \cdot 2} + C = \frac{a^2 t}{2} + \frac{a^2}{2} \sin t \cos t + C. \end{aligned}$$

$$\begin{aligned} \text{Bizda } a \sin t = x, \quad \sin t = \frac{x}{a}, \quad \cos t = \sqrt{1 - \sin^2 t} = \sqrt{1 - \frac{x^2}{a^2}} = \\ = \sqrt{\frac{a^2 - x^2}{a^2}}, \quad t = \arcsin \frac{x}{a}, \end{aligned}$$

$$\begin{aligned} \int \sqrt{a^2 - x^2} dx &= \frac{a^2}{2} \arcsin \frac{x}{a} + \frac{a^2}{2} \cdot \frac{x}{a} \cdot \frac{\sqrt{a^2 - x^2}}{a} + C = \\ &= \frac{a^2}{2} \arcsin \frac{x}{a} + \frac{x}{2} \sqrt{a^2 - x^2} + C. \end{aligned}$$

6-misol.  $\int \frac{6x^2 dx}{2x^3 - 1}$  integralni hisoblaymiz, bunda  $x > \sqrt[3]{\frac{1}{2}}$ .

Yechish.  $(2x^3 - 1)' = 6x^2$  bo'ladi.  $2x^3 - 1 = t$  almashtirish kiritamiz. U holda  $6x^2 dx = dt$ ,

$$\int \frac{6x^2}{2x^3 - 1} dx = \int \frac{dt}{t} = \ln t + C = \ln(2x^3 - 1) + C.$$

Misol natijasiga ko'ra ixtiyoriy differensiallanuvchi funksiya uchun ushbu tenglik o'rinli bo'ladi:  $\int \frac{f'(x) dx}{f(x)} = \ln|f(x)| + C$ .



## Mashqlar

**6.9.** Integrellarni hisoblang:

- 1)  $\int \frac{x^8 - 6x^3 + x + 1}{x^3} dx$ ;      2)  $\int \frac{dx}{36 + x^2}$ ;      3)  $\int \frac{dx}{9x^2 + 25}$ ;  
 4)  $\int \frac{dx}{\sqrt{1 - 25x^2}}$ ;      5)  $\int \cos 4x dx$ ;      6)  $\int \frac{dx}{\cos^2(5x - 6)}$ .

**6.10.** Integrellarni algebraik yig'indiga ajratish yo'li bilan toping:

- 1)  $\int \frac{x^8 - 6x^3 + x + 1}{x^3} dx$ ;      2)  $\int \frac{x^5 + 7x^4 - 5x^2 + 4\sqrt[3]{x^2}}{x\sqrt{x}} dx$ ;  
 3)  $\int \sin^2 5x dx$ ;      4)  $\int \cos^2 5x dx$ ;  
 5)  $\int \sin 3x \cos 3x dx$ ;      6)  $\int \cos 18x \sin 16x dx$ ;  
 7)  $\int \sin 22x \sin 2x dx$ ;      8)  $\int \cos 6x \cos 3x dx$ .

**6.11.** Integrallarni o'zgaruvchilarning almashtirish usulini qo'llab, hisoblang:

- 1)  $\int (5x - 6)^7 dx$ ;      2)  $\int \sqrt{16x + 11} dx$ ;      3)  $\int \frac{5x dx}{\sqrt{16 - x^4}}$ ;  
 4)  $\int \sin 4x dx$ ;      5)  $\int \cos \sqrt{2} x dx$ ;      6)  $\int \frac{dx}{\sin^2(6x - 1)}$ ;  
 7)  $\int \frac{dx}{\sin^2 8x \cos^2 8x}$ ;      8)  $\int (\sin x - \cos x)^2 dx$ ;  
 9)  $\int \frac{dx}{\sqrt{16 - 6x - 7x^2}}$ ;      10)  $\int \frac{dx}{x^2 - 6x + 17}$ .

**6.12.** Integrallarni hisoblang:

- 1)  $\int \frac{x^2 dx}{1 + x^6}$ ;      2)  $\int \frac{x^8 dx}{\sqrt{1 - x^{18}}}$ ;      3)  $\int x^2 \sin(x^3) dx$ ;  
 4)  $\int (3x^2 + 1) \cos(x^3 + x - 1) dx$ ;      5)  $\int \frac{\arcsin^8 x dx}{\sqrt{1 - x^2}}$ ;  
 6)  $\int \frac{\arctg^4 3x dx}{1 + 9x^2}$ ;      7)  $\int \frac{\text{ctg}^4 9x dx}{\sin^2 9x}$ ;      8)  $\int \sin 8x \cdot \cos^5 8x dx$ .

**4. Bo'laklab integrallash.**  $u = u(x)$  va  $v = v(x)$  funksiyalar differensiallanuvchi funksiyalar bo'lsin. Bizga ma'lumki,

$$d(uv) = u dv + v du \quad (1)$$

bo'ladi. (1) ni integrallab,

$$uv = \int u dv + \int v du$$

yoki

$$\int u dv = uv - \int v du \quad (2)$$

ni hosil qilamiz.

(2) formula *bo'laklab integrallash* formulasi deyiladi.

(2) formula  $\int u dv$  integralni undan soddaroq bo'lgan  $\int v du$  integralni integrallashga keltiradi

1 - misol.  $\int x \sin x dx$  integralni hisoblaymiz.

Yechish.  $u = x$ ,  $dv = \sin x dx$  deb faraz qilsak,  $u = x$  ning differensial  $du = dx$  ga,  $dv = \sin x dx$  ning ikkala tomonini integrallasak  $v = -\cos x$  ga ega bo'lamiz. Topilganlarni (2) formulaga qo'ysak:

$$\int x \sin x dx = -x \cos x + \int \cos x dx = -x \cos x + \sin x + C.$$

2-misol.  $\int xe^x dx$  integralni hisoblaymiz.

Yechish.  $u = x, dv = e^x dx$  deb olamiz. Bundan  $du = dx, v = e^x$ .

(2) formulaga asosan

$$\int xe^x dx = xe^x - \int e^x dx = xe^x - e^x + C.$$

Bo'laklab integrallash usuli o'zgaruvchilarni almashtirish usuliga nisbatan qo'llash sohasi torroq bo'lsa-da, lekin shu usul yordami bilan hisoblanadigan ko'plab integrallar mavjud. Masalan:

$$\int x^k e^{ax} dx; \int x^k \ln^m dx; \int \arcsin x dx; \int x^u \cos ax dx.$$



## Mashqlar

6.13. Integrallarni hisoblang:

1)  $\int x \sin 2x dx$ ;    2)  $\int x \cos x dx$ ;    3)  $\int xe^{-x} dx$ ;

4)  $\int x 3^x dx$ ;    5)  $\int \ln x dx$ ;    6)  $\int x \ln x dx$ ;

7)  $\int e^x \cos x dx$ ;    8)  $\int x^2 e^x dx$ ;    9)  $\int \ln^2 x dx$ ;

10)  $\int \arcsin x dx$ .

## 2-§. Aniq integral

**1. Egri chiziqli trapetsiya yuzi. Boshlang'ich funksiya orttirmasi.**

**Aniq integral.** Ko'p masalalar, jumladan, yassi shakllarning yuzlarini hisoblash masalasi integral hisobi orqali hal etiladi.

Geometriya kursidan bizga quyidagi aksiomalar ma'lum:

1) har qanday  $F$  shakl nomanfiy  $S(F)$  yuzga ega;

2) tomoni 1 ga teng kvadratning yuzi 1 ga teng;

3) teng shakllarning yuzlari teng, ya'ni  $F_1 = F_2$  bo'lsa,  $S(F_1) = S(F_2)$  bo'ladi;

4) shaklning yuzi uning barcha kesishmas qismlari yuzlarining yig'indisiga teng.

Quyidan  $OX$  o'qi, yuqoridan nomanfiy  $y = f(x)$  funksiya grafigi, yon tomonlaridan  $x = a, x = b$  to'g'ri chiziqlar bilan chegaralangan shakl *egri chiziqli trapetsiya* deyiladi (VI.2-rasm).

**1-teorema.** Agar  $f$  funksiya  $[a, b]$  oralig'ida monoton bo'lsa, *Egri chiziqli trapetsiya kvadraturalanadi* (yuzini hisoblab bo'ladi).

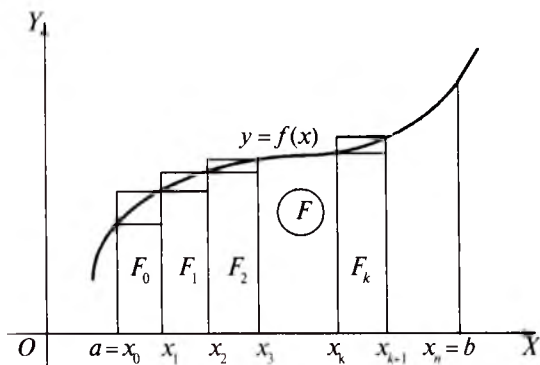

VI.2-rasm.

Isbot.  $f(x)$  funksiya  $[a, b]$  kesmada o'suvchi, deylik. Istalgancha kichik  $\varepsilon > 0$  son uchun har doim shunday  $\Phi_1$  va  $\Phi_2$  ko'pburchaklar topiladiki,  $\Phi_1$  shakl  $F$  ning ichida yotadi,  $\Phi_2$  esa  $F$  ni o'z ichiga oladi va ikkala ko'pburchak yuzlari ayirmasi uchun  $S(\Phi_2) - S(\Phi_1) < \varepsilon$  bo'ladi. Ko'pburchaklarni yasash maqsadida  $[a; b]$  kesmani  $a = x_0 < x_1 < \dots < x_{n-1} < x_n = b$  nuqtalar bilan  $n$  ta teng qismga ajratamiz va bu nuqtalardan  $OY$  o'qiga parallel to'g'ri chiziqlar o'tkazamiz. Ular  $F$  egri chiziqli trapetsiyani  $F_0, F_1, \dots, F_{n-1}$  qismlarga ajratadi. Har qaysi  $[x_k, x_{k+1}]$  kesmada birining balandligi  $f(x_k)$ , ikkinchisidiki  $f(x_{k+1})$  bo'lgan ikkita to'g'ri to'rtburchak yasaymiz.  $f(x)$  funksiya o'suvchi bo'lganidan birinchi to'rtburchak  $F$  trapetsiyaning  $F_k$  qismi ichiga joylashadi, ikkinchisi  $F_k$  ni o'z ichiga oladi. Barcha  $0 \leq k \leq n - 1$  lar uchun birinchi to'rtburchaklar birlashmasi ( $\Phi_2$  pog'onali shakl)  $F$  ichiga joylashadi, ikkinchi to'rtburchaklar birlashmasi ( $\Phi_1$  pog'onali shakl)  $F$  ni o'z ichiga oladi. Yetarlicha katta  $n$  larda  $S(\Phi_1) - S(\Phi_2) < \varepsilon$  bo'ladi. Haqiqatan,

$$\begin{aligned} S(\Phi_2) - S(\Phi_1) &= \frac{b-a}{n} [f(x_1) + \dots + f(x_{n-1}) + f(x_n)] - \\ &\quad - \frac{b-a}{n} [f(x_0) + f(x_1) + \dots + f(x_{n-1})] = \\ &= \frac{b-a}{n} [f(x_n) - f(x_0)] = \frac{b-a}{n} [f(b) - f(a)]. \end{aligned}$$

Bu ayirma  $n$  ning yetarlicha katta qiymatlarida  $\varepsilon$  dan kichik bo'ladi.

$f(x)$  funksiya nomonoton bo'lganda  $[a, b]$  kesmani  $f(x)$  funksiya monoton bo'ladigan qismlarga ajratiladi va har bir qism

uchun teorema alohida qo'llaniladi.

$f(x)$  funksiyaning boshlang'ich funksiyalari to'plami  $F(x) + C$  bo'lsin.  $F(x) + C$  funksiyalarning  $[a, b]$  kesmadagi orttirmasini topamiz:

$$\Delta F = (F(b) + C) - (F(a) + C) = F(b) - F(a), \quad \Delta F = F(b) - F(a). \quad (1)$$

Bundan ko'rinadiki,  $f(x)$  funksiya  $F(x)$  boshlang'ich funksiyaning  $[a; b]$  kesmadagi  $\Delta F$  orttirmasi  $C$  sonning tanlanishiga bog'liq emas.

1 - misol.  $y = 3x^2$  funksiya boshlang'ich funksiyalarining  $[1; 2]$  va  $[10; 20]$  kesmalardagi orttirmalarini topamiz.

Yechish.  $F(x) = \int 3x^2 dx = x^3 + C$ ,  $C$  - ixtiyoriy o'zgarmas.

(1) munosabat bo'yicha:  $[1; 2]$  da  $\Delta F = 2^3 - 1^3 = 7$ ,  $[10; 20]$  da  $\Delta F = 20^3 - 10^3 = 7000$ .

$f(x)$  funksiya ixtiyoriy  $F(x)$  boshlang'ich funksiyasining  $[a; b]$  kesmadagi  $\Delta F(x) = F(b) - F(a)$  orttirmasi funksiyaning shu kesmadagi *aniq integrali* deyiladi va  $\int_a^b f(x) dx$  orqali belgilanadi:

$$\int_a^b f(x) dx = F(b) - F(a).$$

$F(b) - F(a)$  ayirmaning  $F(x)|_a^b$  bilan belgilaymiz. U holda quyidagi tenglik hosil bo'ladi:

$$\int_a^b f(x) dx = F(x)|_a^b. \quad (2)$$

(2) tenglik *Nyuton-Leybnis formulasi* deb ataladi,  $a$  va  $b$  *integrallash chegaralari* deyiladi.

2 - misol. 1)  $\int_0^\pi \cos x dx = \sin x|_0^\pi = \sin \pi - \sin 0 = 0$ .

2)  $\int_a^b \sqrt[3]{x^2} dx = \frac{3x^{\frac{5}{3}}}{\frac{5}{3}} \Big|_a^b = \frac{3}{5} \left( b^{\frac{5}{3}} - a^{\frac{5}{3}} \right)$ .

Quyida aniq integral xossalari isbotlashda Nyuton-Leybnis formulasidan foydalaniladi.



1-xossa. *Funksiyalar yig'indisining aniq integrali shu funksiyalar aniq integrallarining yig'indisiga, o'zgarmas son va funksiya ko'paytmasining aniq integrali esa shu funksiya aniq integralining o'zgarmas songa ko'paytirilganiga teng:*

$$\int_a^b (f_1(x) + f_2(x)) dx = \int_a^b f_1(x) dx + \int_a^b f_2(x) dx; \quad (3)$$

$$\int_a^b Af(x) dx = A \int_a^b f(x) dx. \quad (4)$$

Haqiqatan,  $\int_a^b f_1(x) dx = F_1(b) - F_1(a)$ ,  $\int_a^b f_2(x) dx = F_2(b) - F_2(a)$  bo'lsin. U holda

$$\begin{aligned} \int_a^b (f_1(x) + f_2(x)) dx &= (F_1(b) + F_2(b)) - (F_1(a) + F_2(a)) = \\ &= (F_1(b) - F_2(a)) + (F_2(b) - F_2(a)) = \int_a^b f_1(x) dx + \int_a^b f_2(x) dx. \end{aligned}$$

2-xossa. *Agar integrallash chegaralari almashtirilsa, aniq integral o'z ishorasini o'zgartiradi:*

$$\int_a^b f(x) dx = - \int_b^a f(x) dx. \quad (5)$$

Haqiqatan,  $\int_a^b f(x) dx = F(b) - F(a) = -(F(a) - F(b)) = - \int_b^a f(x) dx$ .

3-xossa.

$$\int_a^a f(x) dx = 0. \quad (6)$$

Chunki  $\int_a^a f(x) dx = F(a) - F(a) = 0$ .

4-xossa. *Ixtiyoriy a, b, c sonlar uchun ushbu tenglik o'rinli:*

$$\int_a^b f(x) dx = \int_a^c f(x) dx + \int_c^b f(x) dx. \quad (7)$$

Haqiqatan,

$$\begin{aligned} \int_a^c f(x) dx + \int_c^b f(x) dx &= (F(c) - F(a)) + (F(b) - F(c)) = \\ &= F(b) - F(a) = \int_a^b f(x) dx. \end{aligned}$$

5-xossa. Agar  $|a; b|$  kesmada  $f(x) > 0$  (yoki  $f(x) < 0$  bo'lsa)

uning shu kesmadagi  $\int_a^b f(x) dx$  aniq integrali ham shunday ishoraga ega bo'ladi.

Haqiqatan  $f(x) = F(x) > 0$ , ya'ni  $F(x)$  funksiya o'suvchi bo'lsin.

U holda  $b > a$  bo'lganidan  $F(b) > F(a)$  ya'ni  $F(b) - F(a) > 0$ ,

$\int_a^b f(x) dx > 0$  bo'ladi ( $f(x) < 0$  holi ham shu kabi isbotlanadi).

3-misol.  $[\pi; \frac{3\pi}{2}]$  kesmada  $\sin x < 0$ , uning shu kesmadagi aniq integrali ham manfiy bo'lishini ko'rsatamiz.

$$\int_{\pi}^{3\pi/2} \sin x dx = -\cos x \Big|_{\pi}^{3\pi/2} = -\left(\cos \frac{3\pi}{2} - \cos \pi\right) = -(0 - (-1)) = -1.$$



## Mashqlar

**6.14.**  $[0; 4]$  kesma necha qismga bo'linisa,  $x = 0$ ,  $x = 4$ ,  $y = 0$ ,  $y = x^2$  chiziqlar bilan chegaralangan shakl uchun  $S(\Phi_2) - S(\Phi_1) < 0,1$  bo'ladi?

**6.15.** Doiraning yuzga egaligini isbotlang.

**6.16.** Integrallarni hisoblang:

$$1) \int_0^2 x^6 dx; \quad 2) \int_0^4 x^2 \sqrt[5]{x} dx; \quad 3) \int_0^1 \frac{x^8 - 9}{x^4 + 3} dx;$$

$$4) \int_{\pi/2}^{\pi} \sin x dx; \quad 5) \int_0^8 (4 \sqrt[3]{x} + 2x) dx; \quad 6) \int_{\pi/6}^{\pi/3} \frac{\sin^3 x + 1}{\sin^2 x} dx;$$

$$7) \int_2^6 \sqrt{2x-3} dx; \quad 8) \int_1^8 4 \sqrt[3]{x} \left(1 - \frac{1}{x}\right) dx;$$

$$9) \int_0^{\pi/4} (2 \cos^2 x - 1) dx; \quad 10) \int_2^9 \sqrt{x-1} dx.$$

**6.17.** Integrallarni hisoblang:

$$1) \int_{-1}^3 (x^2 - 4 + 5) dx; \quad 2) \int_1^2 \frac{6x - 3\sqrt{x}}{x} dx;$$

$$3) \int_{-2}^3 (6x^2 - 2x) dx;$$

$$4) \int_0^{\pi/3} (\sin 2x - \cos x) dx;$$

$$5) \int_{-\pi/2}^{\pi/2} \sin^2 x dx;$$

$$6) \int_0^{\pi} (1 - \cos x)^2 dx;$$

$$7) \int_1^2 \frac{x^6 - 9}{x^3 + 3} dx;$$

$$8) \int_0^8 (4 \sqrt[3]{x} + 2x) dx;$$

$$9) \int_{\pi/4}^{\pi/3} \frac{\sin^3 x + 1}{\sin^2 x} dx;$$

$$10) \int_0^1 \frac{dx}{1+x^2};$$

$$11) \int_0^{\pi/3} \frac{dx}{\cos^2 x}.$$

**2. Nyuton–Leybnis teoremasi.** Matematik analizning muhim qo'llanishlarga ega bo'lgan asosiy natijalaridan biri ingliz matematigi Barrou (1630–1677) tomonidan geometrik shaklda bayon qilingan. Isaak Nyuton (1643–1727) va Leybnis (1646–1716) tomonidan bir-birlaridan mustaqil ravishda uzil-kesil isbotlangan ushbu teoremadir.

**Teorema.** (Nyuton–Leybnis teoremasi).  $f(x)$  funksiya  $[a; b]$  kesmada nomanfiy, uzluksiz va unda chekli sonda ekstremumlarga ega bo'lsin. Shu  $a \leq x \leq b$  kesma ustida joylashgan va yuqoridan  $f(x)$  funksiya grafigi bilan chegaralangan egri chiziqli trapetsiyaning yuzini  $S(x)$  orqali belgilaylik. U holda  $S(x)$  funksiya  $f(x)$  ning boshlang'ich funksiyasi bo'ladi, ya'ni  $[a; b]$  kesmada  $S'(x) = f(x)$  tenglik bajariladi (VI.3-rasm).

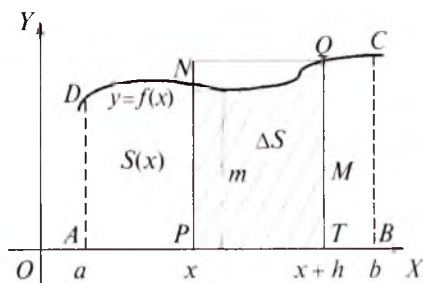

VI.3-rasm.

Isbot. Biz ixtiyoriy  $x \in [a, b]$  nuqta uchun  $S'(x) = f(x)$  tenglikning bajarilishini isbot qilishimiz kerak, bunda

$$S'(x) = \lim_{h \rightarrow 0} \frac{S(x+h) - S(x)}{h}, \quad h = \Delta x.$$

Aniqlik uchun  $h > 0$  deb olamiz.  $S(x+h) - S(x)$  ayirma  $PTQN$  egri chiziqli trapetsiyaning yuziga teng.  $f(x)$  funksiyaning  $[x; x+h]$  dagi eng katta qiymati  $M$  ga, eng kichik qiymati  $m$  ga teng bo'lsin. U holda  $PTQN$  egri chiziqli trapetsiya umumiy asosi  $[x; x+h]$ , balandliklari mos ravishda  $m$  va  $M$  ga teng ikki to'g'ri to'rtbur-chakning o'rtasida joylashadi. Ularning yuzlari:

$$m \cdot h \leq S(x+h) - S(x) \leq M \cdot h, \quad h > 0 \quad (1)$$

yoki

$$m \leq \frac{S(x+h) - S(x)}{h} \leq M,$$

bunda  $m$  va  $M$  lar  $h$  ning tanlanishiga bog'liq.  $f(x)$  funksiya  $x$  nuqtada uzluksiz bo'lganidan,  $h \rightarrow 0$  da uning  $[x; x+h]$  kesmadagi  $m$  va  $M$  qiymatlari birgalikda umumiy  $f(x)$  limitga intiladi:

$$\lim_{h \rightarrow 0} m = \lim_{h \rightarrow 0} M = f(x), \quad S'(x) = \lim_{h \rightarrow 0} \frac{S(x+h) - S(x)}{h} = f(x).$$

Xulosa:  $y = f(x)$  ( $a \leq x \leq b$ ) egri chiziq ostida joylashgan egri chiziqli trapetsiyaning  $S'$  yuzi  $f(x)$  funksiyaning  $[a; b]$

kesmadagi aniq integraliga teng:  $S = \int_a^b f(x) dx$ .

Isbot.  $ABCD$  shaklning  $S$  yuzi (VI.3-rasm)  $S(x)$  funksiyaning  $[a; b]$  kesmadagi  $S = S(b) - S(a)$  orttirmasiga teng. Lekin  $S(x)$  ning o'zi  $f(x)$  ning boshlang'ich funksiyasi. Shunday qilib,

$$S = S(b) - S(a) = \int_a^b f(x) dx.$$

1 - misol.  $OX$  o'qi,  $x = 2$ ,  $x = 6$  to'g'ri chiziqlar va  $f(x) = x^3$  funksiyaning grafigi bilan chegaralangan egri chiziqli trapetsiyaning  $S(x)$  yuzini topamiz.

Yechish.  $x^3$  funksiyaning boshlang'ich funksiyalaridan biri

$F(x) = \frac{x^4}{4} + C$  bo'lsin. Nyuton-Leybnits formulasi bo'yicha:

$$S = \int_a^b x^3 dx = \frac{x^4}{4} \Big|_2^6 = \frac{6^4}{4} - \frac{2^4}{4} = \frac{1}{4}(6^4 - 2^4) = 320.$$

2 - misol.  $\int_{-R}^R \sqrt{R^2 - x^2} dx$  integralning qiymatini hisoblaymiz.

Yechish.  $y = \sqrt{R^2 - x^2}$  tenglikni  $x^2 + y^2 = R^2$  ko'rinishda yozish mumkin. Bu esa har qanday  $M(x; y)$  nuqta radiusi  $R$  bo'lgan va markazi  $(0; 0)$  nuqtada joylashgan aylanada yotishini bildiradi. Egri chizikli trapetsiyaning  $[-R; R]$  kesma ustida joylashgan qismi yarim doiradan iborat va uning yuzi  $\frac{1}{2}\pi R^2$  ga teng:

$$\int_{-R}^R \sqrt{R^2 - x^2} dx = \frac{1}{2}\pi R^2.$$

Integrallash formulasi ham shu natijani beradi:

$$\begin{aligned} \int_{-R}^R \sqrt{R^2 - x^2} dx &= \left( \frac{R^2}{2} \arcsin \frac{x}{R} + \frac{x}{2} \sqrt{R^2 - x^2} \right) \Big|_{-R}^R = \\ &= \frac{R^2}{2} (\arcsin 1 - \arcsin(-1)) = \frac{R^2}{2} \left( \frac{\pi}{2} - \left( -\frac{\pi}{2} \right) \right) = \frac{\pi R^2}{2}. \end{aligned}$$

Agar  $[a; b]$  kesmada  $f(x)$  funksiya musbat va manfiy qiymatlarni qabul qilsa,  $\int_a^b f(x) dx$  ning qiymati egri chizikli trapetsiyaning absissalar o'qidan yuqorida va quyida yotgan qismlarining ayirmasiga teng bo'ladi. Umuman,  $y = f_1(x)$  va  $y_2 = f_2(x)$  ( $f_2(x) \geq f_1(x)$ ) uzluksiz funksiyalar grafiklari va  $x = a$ ,  $x = b$ , ( $a < b$ ) to'g'ri chiziqlar bilan chegaralangan shaklning yuzi  $l(x) = f_2(x) - f_1(x)$  funksiyaning  $[a; b]$  kesmadagi aniq integraliga teng:

$$S = \int_a^b l(x) dx. \quad (2)$$

Isbot. Shaklni  $OX$  o'qidan yuqoriga joylashadigan qilib,  $k$  birlik yuqoriga parallel ko'chiramiz (bu bilan shaklning yuzi o'zgarmaydi).  $f_1(x)$  funksiya  $f_1(x) + k$  ga,  $f_2(x)$  esa  $f_2(x) + k$  ga almashadi. U holda:

$$S = \int_a^b (f_2(x) + k) dx - \int_a^b (f_1(x) + k) dx = \int_a^b (f_2(x) dx + k \int_a^b dx - \int_a^b f_1(x) dx - k \int_a^b dx) = \int_a^b f_2(x) dx - \int_a^b f_1(x) dx = \int_a^b l(x) dx.$$

Ta'kid isbotlandi.

Xususan, agar  $f(x)$  uzluksiz funksiya  $[a; b]$  kesmada manfiy bo'lsa,  $y=f(x)$  egri chiziq,  $OX$  o'qi,  $x=a$  va  $x=b$  ( $a < b$ ) to'g'ri

chiziqlar bilan chegaralangan shaklning yuzi  $\int_a^b (-f(x)) dx$  aniq

integralga teng bo'ladi.

3 - misol.  $y = x^2 + 2$  va  $y = x^2 + 3x$  parabolalar va  $x = 1$ ,  $x = 2$  to'g'ri chiziqlar bilan chegaralangan shaklning yuzini topamiz (VI.4-rasm).

Yechish.  $[1; 2]$  kesmada  $y = x^2 + 3x$  parabola  $y = x^2 + 2$  paraboladan yuqori joylashadi.  $l(x) = (x^2 + 3x) - (x^2 + 2) = 3x - 2$ . (2) formula bo'yicha:

$$S = \int_1^2 (3x - 2) dx = \left( \frac{3}{2} x^2 - 2x \right) \Big|_1^2 = 6 - 4 - \frac{3}{2} + 2 = 2 \frac{1}{2}.$$

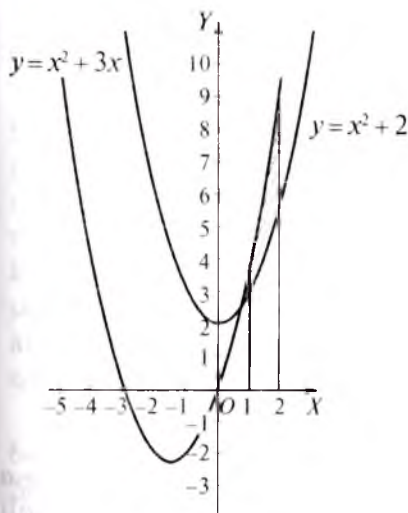

VI.4-rasm.

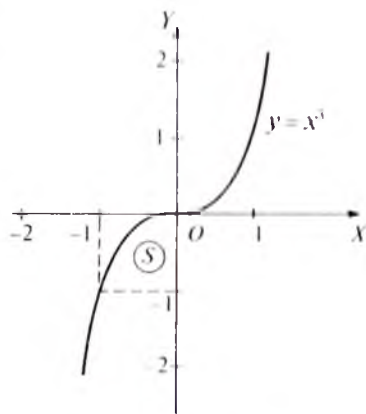

VI.5-rasm.

4 - misol.  $y = x^3$  kub parabola,  $y = -1$  to'g'ri chiziq,  $OY$  o'qi bilan chegaralangan shaklning yuzini topamiz (VI.5-rasm).

Yechish. Misolda faqat bitta  $x = 0$  integrallash chegarasi ko'rsatilgan. Ikkinchi integrallash chegarasini limitni  $y = x^3$  va  $y = -1$  chiziqlarning kesishish nuqtasi beradi:  $x^3 = -1$ , bundan  $x = -1$ . (2) formuladan foydalanamiz.  $[-1; 0]$  kesmada kub parabola  $y = -1$  to'g'ri chiziqdan yuqori joylashganligini ham e'tiborga olsak:

$$l(x) = x^3 - (-1) = x^3 + 1 \text{ va } S = \int_{-1}^0 (x^3 + 1) dx = \left( \frac{x^2}{4} + x \right) \Big|_{-1}^0 = \\ = \frac{1}{4} - 1 = -\frac{3}{4}; \quad |S| = \left| -\frac{3}{4} \right| = \frac{3}{4}.$$

5 - misol.  $x = 0$ ,  $y = 0$ ,  $x = 2$  to'g'ri chiziqlar va  $y = \frac{1}{x+7}$  funksiya grafigi bilan chegaralangan shaklning yuzini topamiz.

Yechish. Izlanayotgan yuz  $\int_0^2 \frac{dx}{x+7}$  integral bilan ifodalanadi.

$x+7 = t$  almashtirish kiritamiz. U holda:

$$\int \frac{dx}{x+7} = \int \frac{dt}{t} = \ln |t| = \ln |x+7|, \quad \int_0^2 \frac{dx}{x+7} = \ln |x+7| \Big|_0^2 = \ln 9 - \ln 7 = \ln \frac{9}{7}.$$



## Mashqlar

6.18. Agar:

1)  $a = 1$ ,  $b = 3$ ,  $f(x) = x^3 - 1$ ;

2)  $a = 0$ ,  $b = \frac{\pi}{3}$ ,  $f(x) = \frac{1}{1+x^2}$ ;

3)  $a = 0$ ,  $b = \pi$ ,  $f(x) = \frac{1}{\cos^2 x}$ ;

4)  $a = 0$ ,  $b = \frac{\sqrt{2}}{2}$ ,  $f(x) = \frac{1}{\sqrt{1-x^2}}$ ;

5)  $a = -1$ ,  $b = 3$ ,  $f(x) = x^2 + 2$ ;

6)  $a = 1$ ,  $b = 8$ ,  $f(x) = \sqrt[3]{x}$

bo'lsa, yuqoridan  $f(x)$  funksiya grafigi, yon tomonlaridan  $x = a$  va  $x = b$  to'g'ri chiziqlar bilan chegaralangan egri chizikli trapetsiyaning yuzini toping.

**6.19.** Quyidagi chiziqlar bilan chegaralangan shaklning yuzini toping:

1)  $y = \frac{1}{x}$ ,  $y = 4x$ ,  $x = 1$ ,  $y = 0$ ;

2)  $y = x^2 + 2$ ,  $y = 2x + 1$ ;

3)  $y = x^2 - 6x + 9$ ,  $y = x^2 + 4x + 4$ ,  $y = 0$ ;

4)  $y = x^2 + 1$ ,  $y = 3x - x^3$ ;

5)  $y = x^2$ ,  $y = 2\sqrt{2}x$ ;

6)  $y = \sqrt{x}$ ,  $y = \sqrt{4 - 3x}$ ,  $y = 0$ .

**6.20.**  $y = \frac{1}{3x-8}$  giperbola,  $x = 3$ ,  $y = 0$ ,  $x = 6$  to'g'ri chiziqlar bilan chegaralangan shaklning yuzini toping.

**6.21.** Erkin tushayotgan jismning dastlabki to'rt sekunda o'tadigan masofani toping.

**6.22.**  $A$  va  $B$  ni  $\int_{-2}^2 (Ax + B)^2 dx = 0$ ,  $\int_{-2}^2 (Ax + B)^2 x dx = 16$

tengliklar bajariladigan qilib tanlang.

**6.23.** Balandligi  $H$  m, asos radiusi  $R$  m bo'lgan silindr shaklidagi idishdan solishtirma og'irligi  $\delta = 78 \cdot 10^3 \text{ N/m}^3$  bo'lgan benzinni so'rib chiqarish uchun sarf bo'ladigan ishni hisoblang.

**6.24.** Yuqori asosi 50 m, balandligi 16 m, quyi asosi 28 m bo'lgan trapetsiya shaklidagi vertikal to'g'onga suv qanday kuch bilan bosadi?

**3. Geometrik va fizik kattaliklarni aniq integral yordamida hisoblash.** Aniq integral yordamida o'zgaruvchan harakat jarayonida o'tilgan yo'lni, egri chiziqli shakllarning yuzini topish mumkinligini ko'rdik. Umuman, aniq integral yordamida geometrik va fizik kattaliklarning o'lchamini topish uchun: 1) noma'lum kattalik o'lchami  $F(b)$  qiymat ko'rinishda izlanadi; 2) buning uchun  $F'(x) = f(x)$  hosila topiladi; 3)  $F(x)$  funksiya  $f(x)$  ning aniq integrali sifatida hisoblanadi; 4) topilgan natijaga  $x = b$  qiymat qo'yiladi va javob topiladi.

1 - misol. YOZ tekislikdan  $x$  birlik uzoqlikda unga parallel bo'lgan  $\alpha$  tekislik ( $A$ ) shaklni kessin (VI.6-rasm). Kesim yuzini  $S(x)$  orqali belgilaylik. Shakl  $x = a$  va  $x = b$  ( $0 < a < b$ ) tekisliklar oralig'ida joylashgan bo'lsin. Shaklning  $V$  hajmini topamiz (hajm tushunchasi geometriya kursida beriladi).



**Y e c h i s h .** Shaklning  $x = x_0$  tekislik bilan kesimini  $\Phi(x_0)$ , uning yuzini  $S(x_0)$  orqali belgilaylik.  $y = S'(x)$  funksiya uzluksiz va  $x_1 < x_2$  da  $\Phi(x_1)$  kesimning  $YOZ$  tekislikdagi proeksiyasi  $\Phi(x_2)$  ning proeksiyasi ichida yotsin, ya'ni shakl  $a$  dan  $b$  ga tomon kengaysin ( $S(x)$  funksiya o'suvchi ma'nosida). Shaklning  $[a; b]$  kesmaga mos qismining hajmi  $V(x)$  bo'lsin.  $V'(x)$  hosilani topamiz. Shu maqsadda biror  $x_0$  qiymatni olib, unga  $h > 0$  ortirma beramiz. Shaklning  $\alpha_1$  va  $\alpha_2$  tekisliklar orasidagi qismining hajmi  $V(x_0 + h) - V(x_0)$  bo'ladi va ushbu qo'sh tengsizlik bajariladi:

$$hS(x_0) \leq V(x_0 + h) - V(x_0) \leq hS(x_0 + h), \quad (1)$$

bunda  $hS(x_0)$  — shu qismning ichiga to'liq joylashadigan silindrik shaklning hajmi,  $hS(x_0 + h)$  — o'sha qismni o'z ichiga olgan silindrik shaklning hajmi. Qo'sh tengsizlikni quyidagi ko'rinishda yozamiz:

$$S(x_0) \leq \frac{V(x_0 + h) - V(x_0)}{h} \leq S(x_0 + h).$$

$y = S(x)$  funksiya  $x_0$  nuqtada uzluksiz,  $h \rightarrow 0$  da  $S(x_0 + h)$  ning qiymati ham,  $\frac{V(x_0 + h) - V(x_0)}{h}$  ning qiymati ham  $S(x_0)$  ga intiladi:

$$V'(x_0) = \lim_{h \rightarrow 0} \frac{V(x_0 + h) - V(x_0)}{h} = S(x_0).$$

Demak,  $y = V(x)$  funksiya  $y = S(x)$  funksiyaning boshlang'ich funksiyasidan iborat. Nyuton—Leybnis formulasi bo'yicha:

$$\int_a^b S(x) dx = V(b) - V(a) = V - 0 = V, \\ V = \int_a^b S(x) dx. \quad (2)$$

Umuman,  $[a; b]$  kesmada  $a$  uzluksiz va nomanfiy bo'lgan  $f(x)$  funksiya grafigi bilan chegaralangan egri chiziqli trapetsiyaning  $OX$  o'qi atrofida aylanishidan hosil bo'ladigan jismning hajmi (VI.7-rasm) ushbu formula bo'yicha hisoblanadi:

$$V = \pi \int_a^b f^2(x) dx. \quad (2')$$

**2 - m i s o l .** Asosining yuzi  $S$  va balandligi  $H$  ga teng bo'lgan piramidaning hajmi  $V$  ni topamiz.

**Y e c h i s h .** Piramida uchini koordinatalar boshi sifatida qabul qilaylik,  $OX$  o'qi esa balandlik bo'yicha pastga yo'nalgan bo'lsin.  $O$  uchdan  $x$  uzoqlikda o'tkazilgan ko'ndalang kesim yuzi  $Q(x)$  bo'lsin. U holda

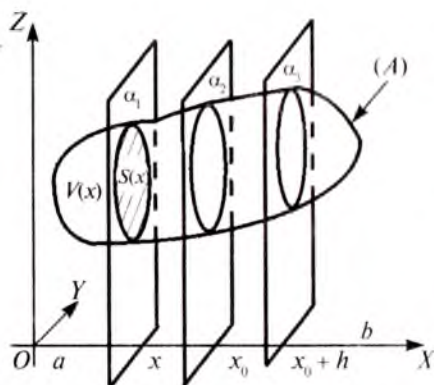

VI.6-rasm.

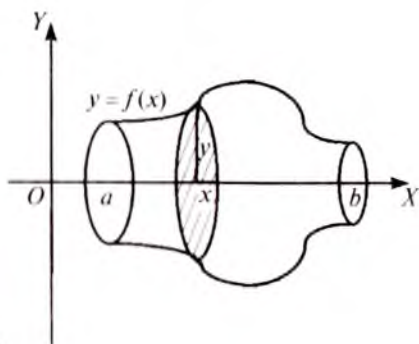

VI.7-rasm.

$$\frac{S}{Q(x)} = \frac{H^2}{x^2}, \text{ bundan } Q(x) = \frac{S}{H^2} x^2, x \in [0; H].$$

$Q(x)$  – uzluksiz, o'suvchi funksiya, uning ko'ndalang kesimining asosdagi proyeksiyalari ichma-ich joylashadi. Bunga qaraganda piramida shunday shaklki, uning istalgan  $x$  ga to'g'ri keladigan ko'ndalang kesimi boshqalari bilan qo'shilib ketmaydi, demak, uning hajmini (2) formula bo'yicha topish mumkin:

$$V = \int_a^H \frac{S}{H^2} x^2 dx = \frac{1}{3} \cdot \frac{S}{H^2} \cdot x^3 \Big|_0^H = \frac{1}{3} SH.$$

3 - m i s o l.  $R$  radiusli sharning hajmini topamiz.

Y e c h i s h. Shar yarim doiraning  $OX$  o'qi atrofida aylanishidan hosil bo'ladi. Yarim aylananing tenglamasi  $y = \sqrt{R^2 - x^2}$ . (2) formula bo'yicha:

$$V = \pi \int_{-R}^R (R^2 - x^2) dx = \pi \left( R^2 x - \frac{x^3}{3} \right) \Big|_{-R}^R = \frac{4}{3} \pi R^3.$$

Fizikada yuqorida bayon qilingan hisoblash sxemasi nisbatan sodda ko'rinishda qo'llaniladi. Izlanayotgan kattalik «cheksiz ko'p sonli cheksiz kichik miqdorlar yig'indisi» sifatida, aniq integral esa shunday yig'indining o'zi deb qaraladi.

Misollar.

1) To'g'ri chiziq bo'ylab  $v(t)$  tezlik bilan harakat qilayotgan jismning  $[t_1; t_2]$  vaqt oralig'ida o'tgan masofasi:

$$s = \int_{t_1}^{t_2} v(t) dt. \quad (3)$$

2) Tok kuchi vaqt bo'yicha elektr miqdorining hosilasiga teng, ya'ni

$$Q = \int_{t_1}^{t_2} I(t) dt. \quad (4)$$

3) Sterjenning massasi  $m$ , uzunligi  $l$ , chiziqli zichligi  $\delta(l)$  bo'lsa,  $\delta(l) = m'(l)$  bo'ladi. U holda  $l = l_1$  dan  $l = l_2$  gacha oraliqdagi sterjen massasi:

$$m = \int_{l_1}^{l_2} \delta(l) dl, \quad (5)$$

bunda  $\delta(l)$  – shu  $l$  ning uzluksiz funksiyasi.



## Mashqlar

**6.25.** Jism  $v(t) = 3t + C$  (m/s) tezlik bilan to'g'ri chiziqli harakat qilmoqda. U  $t_1 = 0$  dan  $t_2 = 3$  (s) gacha vaqt oralig'ida 30 m o'tgan.  $C$  ni toping.

**6.26.** Asosining radiusi  $R = 4$  m, balandligi  $H = 5$  m bo'lgan, vertikal o'rnatilgan silindrik idishdan suvni so'rib olish uchun sarf bo'ladigan ish miqdorini hisoblang.

**6.27.**  $I(t)$  tok kuchi  $t$  vaqtning uzluksiz funksiyasidan iborat.  $t_1 = 0$  dan  $t_2 = 20$  c gacha vaqt oralig'ida  $Q = 10$  K elektr miqdori o'tgan. Tok kuchini toping.

**6.28.** Dastlabki 10 sekund davomida o'tkazgichdan o'tayotgan tok  $I(t) = 8t^3 - 1$  qonun bo'yicha o'zgargan. Shu vaqt ichida o'tkazgichdan qancha tok o'tgan?

**6.29.**  $x^2 = 6y$  va  $y^2 = 6x$  egri chiziqlar bilan chegaralangan shaklning  $OX$  o'qi atrofida aylanishidan hosil bo'ladigan jismning hajmini toping.

**6.30.**  $y = -x + 2,5$  to'g'ri chiziq va  $xy = 1$  gi perbola bilan chegaralangan shaklning  $OX$  o'qi atrofida aylanishidan hosil bo'ladigan jismning hajmini toping.

**4. Aniq integralning qiymatini taqribiy hisoblash.** Agar integral ostidagi  $f(x)$  funksiyaning  $F(x)$  boshlang'ich funksiyasi elementar funksiyalar orqali ifodalanmasa, yoki nisbatan murakkab tuzilishga

ega bo'lsa, yoki aniq javobga ehtiyoj bo'lmasa,  $\int_a^b f(x)dx$  integral taqribiy hisoblanadi. Shu maqsadda oldingi bandlelarda keltirilgan ma'lumotlardan ham foydalanamiz.

1) agar  $a < b$  va  $|a; b|$  kesmada  $f(x) \geq 0$  bo'lsa,  $\int_a^b f(x)dx \geq 0$  bo'ladi;

2) agar  $[a, b]$  kesmada  $\varphi(x) \leq \psi(x)$  bo'lsa,  $\int_a^b \varphi(x)dx \leq \int_a^b \psi(x)dx$  bo'ladi;

3) agar  $[a, b]$  kesmada  $m \leq f(x) \leq M$  bo'lsa,

$$m(b-a) \leq \int_a^b f(x)dx \leq M(b-a) \quad (1)$$

bo'ladi.

Haqiqatan, qo'yilgan shartlarga asosan:

$$\int_a^b m dx \leq \int_a^b f(x)dx \leq \int_a^b M dx.$$

Bundan (1) qo'sh tengsizlik kelib chiqadi.

1 - misol.  $1 \leq \int_1^2 x^2 dx \leq 4$  bo'lishini isbot qilamiz.

Yechish.  $x^2$  funksiya  $[1; 2]$  kesmada o'suvchi, shunga ko'ra uning shu kesmadagi eng kichik qiymati  $m = 1^2 = 1$  ga, eng katta qiymati esa  $M = 2^2 = 4$  ga teng. (1) tengsizliklar bo'yicha:

$$1 \cdot (2-1) \leq \int_1^2 x^2 dx \leq 4 \cdot (2-1)$$

yoki

$$1 \leq \int_1^2 x^2 dx \leq 4.$$

Albatta, yuqorida keltirilgan misolda olingan natijaning aniqligi past. Aniqroq natijani olish uchun  $[a; b]$  kesmani qismlarga ajratamiz. Bu qismlar yetarlicha kichik va  $f(x)$  funksiya uzluksiz bo'lsa,  $f(x)$  ning har qaysi qismdagi eng kichik va eng katta qiymatlari o'rtasidagi farq ham yetarlicha kichik bo'lishi mumkin. Har bir qism uchun integral qiymati nisbatan aniq bo'ladi, u holda ularning yig'indisi  $[a; b]$  kesma bo'yicha olinadigan integral qiymatiga istalgan aniqlikda teng bo'la oladi. Xususan, integral

qiymati yotgan chegaralarni yetarlicha aniqlikda hisoblash mumkin. Shu maqsadda turli taqribiy formulalardan ham foydalanish mumkin.

$f(x)$  funksiya  $[a; b]$  kesmada monoton o'suvchi bo'lsin. Kesmani  $a = x_0 < x_1 < \dots < x_n = b$  nuqtalar bilan teng  $n$  qismga ajratamiz. Har qaysi  $[x_k; x_{k+1}]$  kesmada funksiyaning eng kichik qiymati  $f(x_k)$ , eng katta qiymati  $f(x_{k+1})$ , kesmaning uzunligi  $x_{k+1} - x_k = \frac{b-a}{n}$  ga teng bo'ladi. U holda

$$\frac{b-a}{n} f(x_k) \leq \int_a^b f(x) dx \leq \frac{b-a}{n} f(x_{k+1}). \quad (2)$$

$[a, b]$  kesmaga tegishli qolgan qism kesmalar uchun shunday qo'sh tengsizliklar tuziladi va ular jamlanadi:

$$\frac{b-a}{n} \sum_{k=0}^{n-1} f(x_k) \leq \int_a^b f(x) dx \leq \frac{b-a}{n} \sum_{k=1}^n f(x_k). \quad (3)$$

Bu tengsizliklar  $\int_a^b f(x) dx$  integralni quyidan va yuqoridan

baholaydi, integralni hisoblash masalasini  $f(x)$  funksiyaning  $x_0 = a, x_1, \dots, x_n = b$  nuqtalardagi qiymatlarini hisoblashga keltiradi.  $[a; b]$  kesma qancha kichik bo'laklarga bo'linsa, integral qiymati shuncha aniq baholanadi.

Hisoblashlarda (3) dagi quyi va yuqori chegaralarning o'rtta arifmetigidan foydalanish mumkin:

$$\int_a^b f(x) dx \approx \frac{b-a}{n} \left( \frac{f(a)+f(b)}{2} + f(x_1) + \dots + f(x_{n-1}) \right). \quad (4)$$

Bu munosabat *trapetsiyalar formulasi* nomi bilan ataladi. Bunday atalishining sababi formula bo'yicha hisoblashlarda  $[x_k; x_{k+1}]$  kesmalardagi egri chiziqli trapetsiyalar odatdagi trapetsiyalarga almashgan bo'ladi.

2 - misol.  $\int_1^2 x^2 dx$  integralning qiymatini 0,01 gacha aniqlikda hisoblash uchun  $[1; 2]$  kesma necha qismga bo'linishi kerak?

Yechish. Masalaning shartiga ko'ra  $\frac{2-1}{n}(4-1) \leq 0,01$ , bundan  $n \geq 300$  ni topamiz. Kesma 300 qismga ajratilishi kerak.

3-misol. 1-misolda biz  $\int_1^2 x^2 dx$  integralning 1 va 4 dan iborat chegaralarini olgan edik. Agar  $[1; 2]$  kesma teng o'n bo'lakka ajratilsa, (3) bo'yicha baho quyidagicha bo'lar edi:

$$0,1 \cdot (1^2 + 1,1^2 + \dots + 1,9^2) \leq \int_1^2 x^2 dx \leq 0,1 \cdot (1,1^2 + 1,2^2 + \dots + 2^2),$$

$$2,185 \leq \int_1^2 x^2 dx \leq 2,485.$$

Topilgan chegaralarning o'rta arifmetigi integralning aniqroq qiymatini beradi:  $(2,185 + 2,485)/2 = 2,335$ . Integralning aniq qiymati:

$$\int_1^2 x^2 dx = \left. \frac{x^3}{3} \right|_1^2 = \frac{2^3 - 1^3}{3} = 2,333\dots$$



## Mashqlar

**6.31.** Integrallar qiymatini baholang:

$$1) \int_1^2 \frac{xdx}{(x+3)^2}; \quad 2) \int_0^{\pi/2} \sin^2 0,5x dx; \quad 3) \int_0^3 (x^2 - 2x + 2) dx.$$

**6.32.**  $\frac{\pi}{6} = \arcsin \frac{1}{2} = \int_0^{1/2} \frac{dx}{\sqrt{1-x^2}}$  tenglikdan foydalanib,  $\pi < 3\sqrt{3}$  bo'lishini isbotlang.

**6.33.** Integrallarni trapetsiyalar formulasi bo'yicha hisoblang ( $n = 10$ ):

$$1) \int_0^1 x^4 dx; \quad 2) \int_0^3 \frac{dx}{1+x^2}; \quad 3) \int_2^3 \frac{dx}{\sqrt{1-x^2}};$$

$$4) \int_0^{\pi/3} \cos^3 x dx; \quad 5) \int_0^{\pi/3} \sin^3 x dx; \quad 6) \int_0^{\pi/3} \operatorname{tg} x dx.$$

Bunda funksiyalar qiymatini 0,001 gacha aniqlikda oling. Hisoblashlarda mikrokalkulatordan foydalaning.

## 1-§. Eng sodda differensial tenglamalar

**1. Differensial tenglama haqida tushuncha. Differensial tenglamalarga olib keluvchi masalalar.** Biz shu paytgacha noma'lumlarning qiymati sonlar bo'lgan tenglamalar bilan ish ko'rgan edik. Matematikaning ko'pgina tabiiy masalalari o'rganilayotgan jarayonlarni ifodalovchi noma'lum funksiyalar va ularning hosillarini bog'lovchi munosabatlarga keladi.

Bunday munosabatlarni ifodalovchi tenglamalar *differensial tenglamalar* deyiladi. Agar bunday tenglamadagi noma'lum funksiya bir argumentli bo'lsa, tenglamani *oddiy differensial tenglama* deb ataymiz. Biz asosan odiy differensial tenglamalar bilan shug'ullanamiz.

**Misol.** Agar  $v(t)$  tezlik ma'lum bo'lsa,  $s(t)$  yo'lni topish masalasi  $s'(t) = v(t)$  differensial tenglamani yechishga keladi.

Jumladan,  $v(t) = 8t - 5$  bo'lsa, u holda  $s(t)$  ni topish masalasi  $s'(t) = 8t - 5$  differensial tenglamani yechishga keltiriladi.

Umuman, fizika, texnika, biologiya, kimyo, tibbiyot va iqtisodiyotning ko'pgina amaliy masalalari

$$y'(t) = k \cdot y(t) \quad (1)$$

differensial tenglamani qanoatlantiruvchi  $y(t)$  funksiyani topishga keladi, bu yerda  $k$  — berilgan biror o'zgarmas son. (1) tenglamaning yechimlari esa  $y(t) = ce^{kx}$  ko'rinishdagi har qanday funksiyadan iborat ekanligini ko'rish qiyin emas.  $c$  o'zgarmas ixtiyoriy son, shunga ko'ra (1) differensial tenglamaning yechimi cheksiz ko'p.

**Misolalar:**

1. Boshlang'ich temperaturasi  $T$  ga teng bo'lgan jism temperaturasi 0 ga teng bo'lgan muhitga joylashtirilgan bo'lsin. Temperaturaning  $\Delta t$  vaqt ichida  $\Delta T$  qadar pasayishi  $\Delta T = -kT \cdot \Delta t$  bilan

ifodalanadi, bunda  $k = \text{const}$ ,  $\Delta T = T(t + \Delta t) - T(t)$ .  $\lim_{\Delta t \rightarrow 0} \frac{\Delta T}{\Delta t} = T'$  munosabatdan,  $T'(t) = -kT(t)$  tenglama hosil bo'ladi, unda  $T'(t)$

hosila temperatura pasayishining oniy tezligini ifodalaydi. Birinchi tartibli differensial tenglama hosil bo'ldi.

2. Nyutonning ikkinchi qonuni bo'yicha moddiy nuqtaning  $t$  vaqt momentidagi tezlanishi  $a = \frac{F}{m}$  ga teng, bunda  $F$  – nuqtaga ta'sir etayotgan kuch,  $m$  – nuqta massasi.  $a$  tezlanish  $x$  nuqta koordinatasining vaqt bo'yicha olingan ikkinchi tartibli hosilasiga teng ekanligidan ushbu ikkinchi tartibli differensial tenglamaga ega bo'lamiz:

$$F(t) = mx''(t). \quad (2)$$

3. Muhitning unda harakat qilayotgan nuqtaga  $F$  qarshilik kuchi nuqtaning  $v$  tezligiga proporsional va shu tezlikka qarshi yo'nalgan, ya'ni  $F(t) = -kv(t)$  yoki (2) tenglikka asosan  $mx''(t) = -kv(t)$ , yoki  $v(t) = x'(t)$  bo'lganligidan  $mx''(t) = -kx'(t)$  va shu kabi  $x''(t) = (x'(t))' = v'(t)$  bo'lganligidan  $mv'(t) = -kv(t)$ .

4.  $m$  massali nuqta  $F$  tortilish kuchining ta'siri ostida yerga tushmoqda, ya'ni

$$F(t) = -\gamma \frac{M \cdot m}{x^2(t)},$$

bunda  $\gamma$  – gravitatsiya doimiysi,  $M$  – Yer massasi,  $x$  – nuqtadan Yer markazigacha masofa (tenglikdagi „minus“ ishorasi  $F$  kuch koordinatalar o'qida manfiy yo'nalganligi sababli qo'yilgan).

Tenglikni (2) munosabatdan foydalanib,  $mx''(t) = -\gamma \frac{M \cdot m}{x^2(t)}$

ko'rinishda, yoki  $x = R$  va  $F = -mg$  ekanligidan  $\gamma \frac{M \cdot m}{R^2} = mg$  yoki

$\gamma M = R^2 g$  bo'lgani uchun  $x''(t) = -\frac{R^2 g}{x^2(t)}$  ko'rinishda yozish

mumkin.

5. Nuqta uning muvozanat holatidan chetlanishiga proporsional va shu holat tomon yo'nalgan kuch ta'siri ostida harakat qilmoqda. Muvozanat holatini koordinatalar boshi sifatida qabul qilamiz. U holda  $F(t) = -kx(t)$  bo'ladi va (2) tenglik  $mx''(t) = -kx(t)$  ko'rinishga keladi.

6. *Radioaktiv parchalanish masalasi.* Radioaktiv modda massasi o'zgarishining oniy tezligi berilgan vaqt momentida shu massaga proporsional, ya'ni  $v(t) = -km(t)$  (minus ishorasining qo'yilishi



massaning kamayib borishi sababidan). Lekin  $v(t) = m'(t)$  bo'lganligi uchun tenglama quyidagicha yoziladi:  $m'(t) = -km(t)$ . Bu yerda  $k$  – moddaning radioaktivligiga bog'liq o'zgarmas son.

Bu tenglamaning yechimlari  $m(t) = ce^{-kt}$  funksiyalardan iborat bo'ladi.

Agar vaqtning boshlang'ich  $t = 0$  momentida radioaktiv moddaning massasi  $m(0) = m_0$  bo'lsa, u holda  $m(0) = ce^{-0} = c$  bo'ladi.

Bundan:

$$m(t) = m_0 e^{-kt} \quad (3)$$

ekanligi kelib chiqadi.

Radioaktiv moddaning massasi ikki marta kamayadigan vaqt oralig'i  $T$  radioaktiv moddaning *yarim yemirilish davri* deyiladi. Agar bizga  $T$  ma'lum bo'lsa,  $k$  ni topish mumkin. Haqiqatan,  $t = T$  da (3) dan  $\frac{m_0}{2} = m_0 e^{-kt}$  ni olamiz. Bundan  $k = \frac{\ln 2}{T}$ ;  $k$  ning topilgan qiymatini (3) ga qo'ysak, u quyidagi ko'rinishni oladi:

$$m(t) = m_0 \cdot 2^{-\frac{t}{T}}.$$

Masalan, radiy uchun  $T \approx 1550$  yil. Shunga ko'ra

$$k = \frac{\ln 2}{1550} \approx 0,000447.$$

Million yildan keyin radiyning boshlang'ich massasidan

$$m(10^6) \approx m_0 e^{-447} \approx 0,6 \cdot 10^{-194} \cdot m_0$$

qoladi.

Ko'pgina amaliy masalalar davriy jarayonlarni o'rganishga keladi. Masalan, matematik mayatnik yoki torning harakati, o'zgaruvchan tok, magnit maydon bilan bog'liq bo'lgan jarayonlar. Bunday jarayonlar *garmonik tebranishlar* deyiladi. Garmonik tebranishlar

$$y''(t) = \omega^2 y(t) \quad (5)$$

differensial tenglamani yechishga keltiriladi, bu yerda  $\omega$  – berilgan musbat son. Bu tenglamaning yechimlari

$$y(t) = A \cos(\omega t + \varphi) \quad (6)$$

ko'rinishdagi funksiyalardan iborat,  $A$  va  $\varphi$  o'zgarmas sonlar masalaning shartlari bo'yicha aniqlanadi.

Masalan, agar  $y(t)$  erkin tebranayotgan tor nuqtasining  $t$  momentdagi muvozanat holatidan chetlanishi bo'lsa, u holda  $y(t) = A \cos(\omega t + \varphi)$  bo'ladi, bu yerda  $A$  — tebranish amplitudasi,  $\omega$  — chastota,  $\varphi$  — boshlang'ich faza.

Garmonik tebranishlarning grafiklari sinusoida ko'rinishida bo'ladi.

Yuqorida qaralgan misollar mazmunida nuqta koordinatasidan iborat  $x(t)$  kabi noma'lum (izlanayotgan) funksiyalar, ularning  $x'(t)$ ,  $x''(t)$  kabi hosilalari va  $t$  erkli o'zgaruvchilar qatnashadi. Demak, ulardan tuzilgan tenglamalar differensial tenglamalardir. Tenglama tarkibidagi hosilaning eng yuqori tartibi shu *tenglamaning tartibi* deyiladi. 2–5- misollarda ikkinchi tartibli, 1, 6- misollarda birinchi tartibli differensial tenglamalar qaraldi.



## Mashqlar

**7.1.**  $y = 3e^{-7x}$  funksiya  $y' = -7y$  tenglamani qanoatlantirishini isbotlang.

**7.2.** To'g'ri chizikli harakat qilayotgan jismning tezligi  $v(t) = 3t - 2t^2$  ga teng. Harakat boshlangandan to to'xtaguncha o'tgan yo'lni toping.

**7.3.** Quyidagilardan qaysilari differensial tenglama va qanday tartibli:

$$1) (y'')^4 = y^3 + x - 3;$$

$$2) y' = \frac{3x^2}{x-y};$$

$$3) \operatorname{tg} y = \sin x + 1;$$

$$4) y''' - 5y'' + 4 = \cos x?$$

**7.4.** Massasi  $m$  bo'lgan moddiy nuqta og'irlik kuchi ta'sirida erkin tushmoqda. Havo qarshiligini hisobga olmasdan nuqtaning harakat qonunini toping.

**7.5.** Qarshilik ko'rsatuvchi muhitda jismning erkin tushish differensial tenglamasini tuzing, bunda muhitning qarshiligi jism tezligi kvadratiga proporsional.

**7.6.**  $y = F(x)$  egri chiziq  $A(0; 1)$  nuqtadan o'tib, uning har bir nuqtasidan o'tgan urinmaning burchak koeffitsiyenti urinish nuqtasining koordinatalari ko'paytmasining ikkilanganiga teng. Shu egri chiziqni toping.

**2. Eng sodda differensial tenglamalarni yechish.** Differensial tenglamaning *yechimi* deb, shu tenglamaga qo'yilganda uni ayniyatga aylantiruvchi ixtiyoriy funksiyaga aytiladi. Yechimning

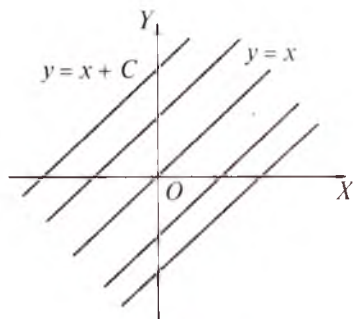

VII.1-rasm.

grafigi tenglamaning *integral egri chizig'i* deyiladi.

Biz 1-bandda differensial tenglamani cheksiz ko'p funksiyalar qanoatlantirishi haqida fikr yuritgan edik. Bu yechimlar majmuasi *umumiy yechim* deyiladi. Umumiy yechimdan birortasini ajratib ko'rsatish uchun funksiyaning argumentni birorta qiymatiga mos keladigan qiymatini ko'rsatish lozim, ya'ni  $x = x_0$  da  $y = y_0$  bo'ladigan shart berilishi kerak. Bu

shart *boshlang'ich shart* deyiladi va  $y(x_0) = y_0$  ko'rinishida yoziladi.

Differensial tenglamaning boshlang'ich shartni qanoatlantiruvchi yechimi uning *xususiy yechimi* deb ataladi.

1-misol.  $y' = 1$  differensial tenglamaning umumiy yechimi  $y = x + C$  funksiyadan iborat, bunda  $C$  — ixtiyoriy son. Buni tekshiramiz.

Yechish.  $y' = (x + C)' = 1$ . Topilgan natija berilgan tenglamaga qo'yilsa,  $1 = 1$  ayniyat hosil bo'ladi.  $C$  ning turli qiymatlariga tenglamaning turli xususiy yechimlari mos keladi. Ular koordinatalar tekisligida  $y = x$  bissektrisaga ( $C = 0$  holi) parallel to'g'ri chiziqlar to'plamini tashkil etadi (VII.1- rasm).

Umuman,  $y' = F(x)$  (1) ko'rinishdagi tenglamalar eng *sodda differensial tenglamalardir*. (1) tenglamani yechish uchun uni  $\frac{dy}{dx} = f(x)$  ko'rinishga, so'ngra  $dy = f(x)dx$  ko'rinishga keltiramiz. Endi tenglikning ikkala qismini integrallasak  $\int dy = \int f(x)dx$  yoki  $y = \int f(x)dx$  ga ega bo'lamiz. Agar  $F(x)$  funksiya  $f(x)$  funksiyaning boshlang'ich funksiyalaridan biri bo'lsa, izlanayotgan umumiy yechim quyidagi ko'rinishda bo'ladi:

$$y = \int f(x)dx = F(x) + C. \quad (2)$$

Differensial tenglamani yechish uni *integrallash* deyiladi. Odatda differensial tenglamaga o'zgarmas  $C$  ni aniqlaydigan

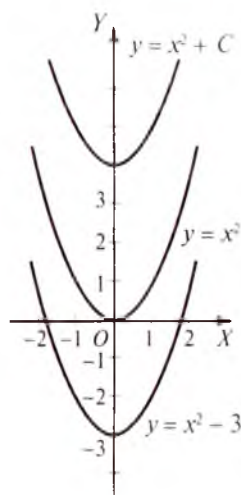

VII.2-rasm.

boshlang'ich shartlar qo'yiladi.

2 - misol.  $y' = 2x$  differensial tenglamaning  $y(1) = -2$  shartni qanoatlantiruvchi xususiy yechimini topamiz.

Yechish. Dastlab umumiy yechimini topamiz:

$$dy = 2x dx,$$

$$\int 2x dx = 2 \cdot \frac{x^2}{2} + C = x^2 + C.$$

Bu yechim  $y = x^2 + C$  parabolalar oilasini ifodalaydi (VII.2-rasm).  $C$  ni  $y(1) = -2$  shartdan foydalanib topamiz:  $-2 = 1^2 + C$ , bundan  $C = -3$ . Demak, izlanayotgan xususiy yechim  $y = x^2 - 3$  ekan.

$y' = F(x; y)$  ko'rinishdagi differensial tenglama ham  $y' = f(x)$  tenglama kabi tahlil qilinadi.

3 - misol.  $y' = \frac{y}{x}$  tenglamaning umumiy yechimi  $y = Cx$  ( $C$  - ixtiyoriy doimiy) funksiyadan iboratligini tekshiramiz va ( $x = 1, y = 1$ ), ( $x = 0, y = 0$ ) qiymatlarga mos xususiy yechimlarini topamiz.

Yechish.  $y = Cx$  va  $y' = C$  ifodalarni berilgan tenglamaga qo'ysak, tenglama ayniyatga aylanadi:  $C = C$ . Demak,  $y = Cx$  umumiy yechim. Xususiy yechimni topish uchun  $y = Cx$  ga oldin  $x = 1, y = 1$  ni qo'yamiz:  $C = 1$ . Bunga mos xususiy yechim  $y = x$  bo'ladi (VII.3-rasm).

Endi  $y = Cx$  ga  $x = 0, y = 0$  ni qo'yamiz:  $0 = C \cdot 0$ . Bu tenglik  $C$  ning bitta emas, balki har qanday qiymatida bajariladi, ya'ni  $(0; 0)$  nuqtadan cheksiz ko'p  $y = Cx$  to'g'ri chiziqlar o'tadi (VII.3-rasm).  $(0; 0)$  nuqta  $y' = \frac{y}{x}$  differensial tenglamaning *maxsus* nuqtasidan iborat.

4 - misol.  $y' = -\frac{x}{y}$  tenglamani yechamiz.

Yechish. Tenglama ifodasi ustida zarur almashtirishlarni bajarib, yechimni topamiz:

$$\frac{dy}{dx} = -\frac{x}{y}, \quad y dy = -x dx, \quad \int y dy = -\int x dx,$$

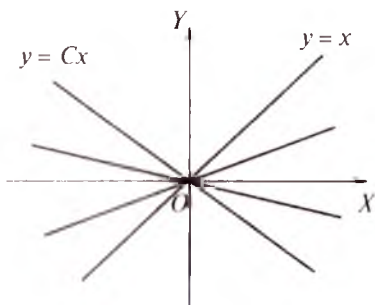

VII.3-rasm.

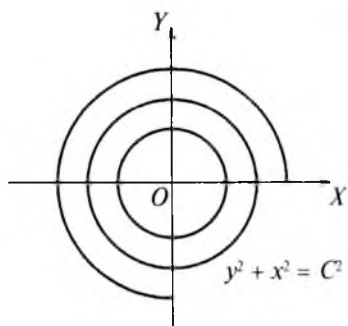

VII.4-rasm.

$$\frac{y^2}{2} = -\frac{x^2}{2} + \frac{C^2}{2} \quad \text{ёки} \quad y^2 + x^2 = C^2,$$

$C$  – ixtiyoriy son. Tenglamaning integral chiziqlari umumiy markazi  $O(0; 0)$  koordinatalar boshida joylashgan konsentrik aylanalardan iborat (VII.4-rasm). Bu holda  $O(0; 0)$  nuqta undan birorta ham aylana (integral chiziq) o'tmaydigan maxsus nuqta. Demak, yechim markazi teshilgan nuqta bo'lgan aylanalardan iborat.

Eng sodda ikkinchi tartibli  $y'' = f(x)$  differensial tenglama  $z = y'$  va  $z' = (y')' = y''$  almashtirish orqali  $z' = f(x)$  birinchi tartibli tenglama ko'rinishiga keltirib yechiladi:

$$z = \int f(x)dx = F(x) + C_1,$$

bunda  $F$  funksiya  $f$  ning boshlang'ich funksiyalaridan biri,  $C$  – ixtiyoriy son.  $y' = z$  bo'lgani uchun:

$$y = \int (F(x) + C_1)dx = \Phi(x) + C_1x + C_2,$$

bunda  $\Phi$  funksiya  $F$  ning boshlang'ich funksiyalaridan biri,  $C_2$  – ikkinchi ixtiyoriy son.

5 - m i s o l .  $y'' = x^2$  tenglamani yechamiz.

Y e c h i s h . Berilgan tenglama ikki marta integrallanadi:

$$y' = \int y'' dx = \int x^2 dx = \frac{x^3}{3} + C_1,$$

$$y = \int \left( \frac{x^3}{3} + C_1 \right) dx = \frac{x^4}{3 \cdot 4} + C_1 x + C_2 = \frac{x^4}{12} + C_1 x + C_2.$$

Birinchi tartibli tenglamaning umumiy yechimida bitta, ikkinchi tartibli tenglamada esa ikkita ixtiyoriy o'zgarmas qatnashayotganini ko'rdik. Umuman,  $n$ -tartibli differensial tenglamaning yechimi  $n$  ta ixtiyoriy songa bog'liq bo'ladi.

6 - m i s o l . Moddiy nuqta  $a(t) = 10$  m/min<sup>2</sup> tezlanish bilan to'g'ri chiziqli harakat qilmoqda.  $t = 3$  min da  $S = 52$  m masofani o'tgan va 47 m/min tezlikka erishgan. Harakat tenglamasini tuzamiz.

Y e c h i s h . Tezlikni  $x'(t)$ , tezlanishni  $x''(t)$  orqali belgilaylik. Quyidagilarni hosil qilamiz:

$$x' = v = \int x'' dt = \int 10 dt = 10t + C_1 = 47 \text{ va } t = 3 \text{ da } 10 \cdot 3 + C_1 = 47,$$

bundan  $C_1 = 17$ ;

$$S = x = \int x' dt = \int (10t + C_1) dt = 5t^2 + 17t + C_2,$$

$$5 \cdot 3^2 + 17 \cdot 3 + C_2 = 52, C_2 = -44.$$

Izlanayotgan tenglama:  $x = 5t^2 + 17t - 44$ .

7 - m i s o l.  $x''(t) + \omega^2(t)x = 0$ , bunda  $\omega^2(t) = \frac{k}{m}$ , differensial tenglamaning yechimi  $x = C_1 \cos \omega t + C_2 \sin \omega t$  ko'rinishda ifodalanihini ko'rsatamiz, bunda  $C_1$  va  $C_2$  - ixtiyoriy o'zgar-maslar, va  $x(0) = x_0$ ,  $x'(0) = v_0$  shartlarni qanoatlantiruvchi xususiy yechimni topamiz.

Y e c h i s h.  $x$  yechim ifodasi bo'yicha  $x' = -C_1 \omega \sin \omega t + C_2 \omega \cos \omega t$  va  $x'' = -C_1 \omega^2 \cos \omega t - C_2 \omega^2 \sin \omega t$  hosilalarni topib, berilgan teng-lamaga qo'yilsa, ushbu ayniyat hosil bo'ladi:

$$-C_1 \omega^2 \cos \omega t - C_2 \omega^2 \sin \omega t + \omega^2 (C_1 \cos \omega t + C_2 \sin \omega t) = 0.$$

Endi  $t = 0$  bo'lgan holga mos xususiy yechimni topamiz:

$$x(0) = C_1 \cos 0 + C_2 \sin 0, C_1 = x_0,$$

$$x'(0) = -C_1 \omega \sin 0 + C_2 \omega \cos 0 = C_2 \omega = v_0, C_2 = \frac{v_0}{\omega}.$$

U holda umumiy yechim munosabati bo'yicha:

$$x = x_0 \cos \omega t + \frac{v_0}{\omega} \sin \omega t.$$



## Mashqlar

7.7.  $f$  funksiya ko'rsatilgan differensial tenglamaning yechimi bo'lishini tekshiring:

1)  $y' = \frac{x^5 - 1}{x^4}$ ,  $f = \frac{x^2}{2} + \frac{1}{3x^3} + C$ ;

2)  $xy' - 2y = 2x^4$ ,  $f = Cx^2 + x^4$ ;

3)  $y' = 1 + \cos y$ ,  $f = 2 \arctg(x + C)$ ;

4)  $(x^2 + y^2)y' = 2xy$ ,  $f = \frac{C \pm \sqrt{C^2 + 4x^2}}{2}$ ;

$$5) y' = y^4, f = -\frac{1}{\sqrt[3]{3(x+C)}}.$$

**7.8.**  $C_1, C_2, C_3$  ning ixtiyoriy qiymatlarida  $F$  funksiya quyidagi differensial tenglamaning yechimi bo'lishini isbot qiling:

$$1) y''' = 2(y'' - 1)\operatorname{ctgx}, \quad 2F(x) = C_1 \cos 2x + x^2 + C_2 x + C_3;$$

$$2) (y'')^2 + y' = xy'', \quad y = C_1 \frac{x^2}{2} - C_1^2 x + C_2.$$

**7.9.**  $(3 - x)y^5 = 8(x + 2)$  funksiya  $yy'' = 0,4(x + 2)(y')^2$  differensial tenglamani va  $y(2) = 32, y'(2) = 40$  boshlang'ich shartlarni qanoatlantirishini tekshiring.

**7.10.**  $y(x + 2) = -x - 6$  funksiya  $2y''' - 3(y')^2 = 0$  differensial tenglamani va  $y(0) = -31, y'(0) = 1, y''(0) = -1$  boshlang'ich shartlarni qanoatlantirishini tekshiring.

**7.11.** Jism  $x''(t) = 2$  tenglama bo'yicha to'g'ri chiziqli harakat qilmoqda. Tenglamaning umumiy yechimini va  $x(2) = 6, x'(2) = 4$  boshlang'ich shartlarni qanoatlantiruvchi xususiy yechimini toping.

## 2-§. Birinchi tartibli oddiy differensial tenglamalar

**1. O'zgaruvchilari ajraladigan tenglamalar.** Agar differensial tenglama

$$y' = \varphi(x)\psi(y) \quad (1)$$

ko'rinishda, ya'ni chap qismida  $y'$  hosila, o'ng qismida biri  $x$  ga, ikkinchisi  $y$  ga bog'liq bo'lgan ikki funksiyaning ko'paytmasi turgan bo'lsa, bunday differensial tenglamani yechishda  $x$  va  $y$  ga bog'liq ifodalar bir-birlaridan ajratiladi. Ikki hol uchraydi:

1) agar  $y = y_0$  da  $\psi(y_0) = 0$  bo'lsa,  $y_0$  — yechimlardan biri bo'ladi. Haqiqatan,  $y_0$  o'zgarmas sonligidan  $(y_0)' = 0$  va  $\varphi(x) \cdot \psi(y_0) = \varphi(x) \cdot 0 = 0$ , ya'ni (1) tenglama  $0 = 0$  dan iborat ayniyatga aylanadi:

2)  $\psi(y) \neq 0$  bo'lgan sohada (1) munosabat  $\frac{dy}{dx} = \varphi(x)\psi(y)$  yoki  $\frac{dy}{\psi(y)} = \varphi(x)dx$  ko'rinishga keladi va

$$\int \frac{dy}{\psi(y)} = \int \varphi(x)dx \quad (2)$$

integral olinadi. Demak,  $\psi(y) \neq 0$  da (1) differensial tenglama (2) munosabatni qanoatlantiruvchi yechimga ega. Shuningdek.



$\psi(y_0) = 0$  ni qanoatlantiruvchi  $y = y_0$  funksiyalar ham (1) tenglamaning yechimlari bo'ladi.

**Misol.**  $y' = (1 + y^2)(x + 1)$  differensial tenglamaning umumiy yechimini va  $y(0) = 1$  boshlang'ich shartni qanoatlantiruvchi xususiy yechimini topamiz.

**Yechish.**  $1 + y^2$  funksiya hech qanday  $y_0$  da nolga aylanmaydi. Tenglamadagi o'zgaruvchilarni ajratamiz, so'ng integrallashni bajarimiz:

$$\frac{dy}{1+y^2} = (1+y^2)(x+1), \quad \frac{dy}{1+y^2} = (x+1)dx, \quad \int \frac{dy}{1+y^2} = \int (1+x)dx,$$

$$\arctg y = x + \frac{x^2}{2} + C, \quad y = \operatorname{tg} \left( \frac{x^2}{2} + x + C \right),$$

bunda  $C$  ixtiyoriy son  $\left(-\frac{\pi}{2}; \frac{\pi}{2}\right)$  oraliqdan olinadi (argumentga  $\pi$  ning qo'shilishi tangens qiymatini o'zgartirmaydi). Xususiy yechimni topish uchun oldin  $C$  ni topish maqsadida umumiy yechimga  $x = 0, y = 1$  larni qo'yib,  $\arctg 1 = C$  yoki  $C = \frac{\pi}{4}$  ni olamiz, so'ng

$$C = \frac{\pi}{4} \text{ ni umumiy yechimga qo'yamiz: } y = \operatorname{tg} \left( \frac{x^2}{2} + x + \frac{\pi}{4} \right).$$



## Mashqlar

**7.12.** Differensial tenglamalarni yeching:

1)  $y' = 9 + y^2$ ; 2)  $y' = xy^3$ ; 3)  $y' = -\frac{1+y}{x-1}$ ;

4)  $y' = \frac{x^4}{\cos 5y}$ ; 5)  $y' = x^5 \sqrt{1-y^2}$ ; 6)  $\sqrt{1-x^2} \cdot y' = 2\sqrt{y}$ .

**7.13.**  $y' = x^3 y^2$  differensial tenglamaning  $y(1) = 2$  boshlang'ich shartni qanoatlantiruvchi yechimini toping.

**7.14.** Differensial tenglamalarni yeching:

1)  $y^3 y'' = 1$ ; 2)  $y'' = 2yy'$ .

**2. Birinchi tartibli chiziqli differensial tenglamalar.**

$$\frac{d}{dx} + a(x)y = b(x) \quad (1)$$

ko'rinishdagi tenglamalar birinchi tartibli *chiziqli differensial tenglamalar* deyiladi. Bu tenglamalarni yechishning bir necha usullari mavjud. Biz quyida *ixtiyoriy o'zgarmasni variatsiyalash usuli (Lagranj usuli)* bilan tanishamiz.



Buning uchun (1) tenglamadagi  $b(x) = 0$  bo'lgan quyidagi

$$\frac{dy}{dx} + a(x)y = 0$$

bir jinsli tenglamani qaraymiz. Bu tenglamani yechish uchun uni quyidagi ko'rinishda yozib olamiz:

$$\frac{dy}{y} = -a(x)dx.$$

Bundan bir jinsli tenglamaning umumiy yechimi  $y = Ce^{-\int a(x)dx}$  bo'ladi. Berilgan (1) tenglamaning umumiy yechimini topish uchun  $C$  ni  $C(x)$  deb hisoblab,

$$y = C(x)e^{-\int a(x)dx} \quad (2)$$

dan  $y'$  ni topamiz:

$$y' = C'(x)e^{-\int a(x)dx} - C(x)e^{-\int a(x)dx} \cdot a(x).$$

$C(x)$  ni topish uchun  $y$  va  $y'$  ni topilgan ifodalarini (1) ga qo'yib,  $C(x)$  ga nisbatan quyidagi tenglamaga ega bo'lamiz:

$$C'(x) = b(x)e^{\int a(x)dx}.$$

Bundan

$$C(x) = C + \int b(x)e^{\int a(x)dx}, \quad (3)$$

bu yerda  $C$  — ixtiyoriy o'zgarmas. (3) munosabatdagi  $C(x)$  ni (2) ga qo'yib, (1) tenglamaning umumiy yechimini topamiz:

$$y = e^{-\int a(x)dx} \left[ C + \int b(x)e^{\int a(x)dx} dx \right], \quad (4)$$

(1) tenglamaning  $y(x_0) = y_0$  boshlang'ich shartni qanoatlantiruvchi xususiy yechimi quyidagi ko'rinishda bo'ladi:

$$y = e^{-\int_{x_0}^x a(t)dt} \left[ y_0 + \int_{x_0}^x b(\tau)e^{\int a(\tau)d\tau} d\tau \right]. \quad (5)$$

1 - misol.  $y' + y \cos x = \frac{1}{2} \sin 2x$  tenglamani yechamiz.

Yechish. Berilgan tenglamada  $a(x) = \cos x$ ,  $b(x) = \frac{1}{2} \sin 2x$ .

$y' + y \cos x = 0$  tenglamaning umumiy yechimini topamiz:

$$\frac{dy}{dx} = -y \sin x \quad \text{yoki} \quad \frac{dy}{dx} = -\cos x dx. \quad \text{Bundan} \quad \ln y = -\sin x + \ln C,$$

$y = Ce^{-\sin x}$ . Topilgan umumiy yechimdan  $C = C(x)$  deb hisoblab, uning hosilasini topamiz:

$$y' = C'(x)e^{-\sin x} - C(x)e^{-\sin x} \cos x,$$

$y'$  va  $y = C(x)e^{-\sin x}$  ifodalarni berilgan tenglamaga qo'ysak,  $C'(x) = e^{\sin x} \sin x \cos x$  ni olamiz. Bundan

$$C(x) = \int e^{\sin x} \sin x \cos x dx = \sin x \cdot e^{\sin x} - e^{\sin x} + C_1.$$

$C(x)$  ning topilgan qiymatini  $y = C(x)e^{-\sin x}$  ifodaga qo'ysak, chiziqli tenglamaning umumiy yechimi quyidagicha bo'ladi:

$$y = \left[ e^{\sin x} (\sin x - 1) + C_1 \right] \cdot e^{-\sin x} = \sin x - 1 + C_1 \cdot e^{-\sin x}.$$

2-misol.  $y' - 2xy = e^{x^2}$  tenglamani yechamiz.

**Yechish.** Tenglamani yechishda (4) formuladan foydalanamiz.  $a(x) = -2x$ ,  $b(x) = e^{x^2}$  bo'lganligi uchun berilgan tenglamaning umumiy yechimi quyidagicha topiladi:

$$\begin{aligned} y &= e^{\int (-2x) dx} \left[ C + \int e^{x^2} \cdot e^{-\int 2x dx} dx \right] = e^{x^2} \left[ C + \int e^x \cdot e^{-x^2} dx \right] = \\ &= e^{x^2} [C + \int dx] = e^{x^2} [C + x + C_1] = e^{x^2} (C + x) = x + C \cdot e^{x^2}. \end{aligned}$$



## Mashqlar

**7.15.** Differensial tenglamalarning umumiy yechimini toping:

1)  $y' + \frac{y}{x} = x$ ;    2)  $xy' - 3y = -x^2$ ;    3)  $y' - \frac{y}{\sin x} = \cos x - 1$ .

**7.16.**  $y' - y \operatorname{tg} x = \frac{1}{\cos x}$  differensial tenglamaning  $y(0) = 1$  shartni qanoatlantiradigan xususiy yechimini toping.

**7.17.**  $xy' - \frac{y}{x+1} = x$  differensial tenglamaning  $y(0) = 1$  shartni qanoatlantiradigan xususiy yechimini toping.



## VIII B O B

# KOMBINATORIKA ELEMENTLARI

### 1-§. Kombinatorikaning asosiy qoidalari

**1. Kombinatorikada nima o'rganiladi?**  $A = \{1, 2, 3\}$  va  $B = \{a, b\}$  to'plamlar elementlaridan shunday juftliklar tuzaylikki, ulardagi birinchi o'rinda  $A$  ning tartib bilan olingan elementi, ikkinchi o'rinda  $B$  ning tartib bo'yicha olingan elementi yoziladigan bo'lsin. Hosil bo'ladigan juftliklar to'plamini  $A \times B$  orqali belgilasak,

$$A \times B = \{(1, a), (1, b), (2, a), (2, b), (3, a), (3, b)\}.$$

Agar birinchi o'ringa  $B$  elementlari qo'yiladigan bo'lsa, yozilish tartibi bilan oldingisidan farq qiladigan

$$B \times A = \{(a, 1), (a, 2), (a, 3), (b, 1), (b, 2), (b, 3)\}$$

to'plam hosil bo'ladi.

$(1, a), (1, b), \dots$  juftliklar (ikkitaliklar) tarkibidagi elementlar shu juftlikning *komponentalari* yoki *koordinatalari* deyiladi (lotincha *componentis* – tashkil etuvchi).

Shu kabi berilgan  $A, B, C$  to'plamlar elementlaridan tartiblangan *uchtaliklar*, umuman,  $k$  ta to'plam elementlaridan tartiblangan  $k$  *taliklar* to'plami tuziladi.  $k$  ta har xil elementli to'plam uzunligi  $n = k$  ga teng deyiladi. Masalan,  $(1, 9, 25)$  va  $(\sqrt{1}, \sqrt{81}, \sqrt{625})$  uchliklar teng va bir xil uzunlikda ( $n = 3$ ), komponentalari:  $1 = \sqrt{1}$ ,  $9 = \sqrt{81}$ ,  $25 = \sqrt{625}$ . Lekin  $(a, b, c)$  va  $(c, a, b)$  uchliklarning uzunliklari va koordinatalari bir xil bo'lsa-da, lekin ular teng emas, chunki koordinatalar turli tartibda joylashgan.  $(1, 2, 3)$  va  $(1, 2, 3, 4)$  lar uzunligi har xil, demak o'zlari ham teng emas.

$k$  talikda komponentalar to'plamlardan va boshqa narsalardan iborat bo'lishi ham mumkin. Shunga ko'ra  $(\{a, b\}, c)$  va  $(\{b, a\}, c)$  ikkitaliklar teng, chunki  $\{a, b\}$  va  $\{b, a\}$  bitta to'plam. Lekin  $((a, b), c)$  va  $((b, a), c)$  ikkitaliklar teng emas, chunki  $(a, b)$  juftlik  $(b, a)$  juftlikka teng emas.  $(a, b, c), ((a, b), c), (a, (b, c))$  lar ham har xil: birinchisi uchtalik, ikkinchi va uchinchi har xil ikkitaliklar.

Birorta ham komponentaga ega bo'lmagan (ya'ni 0 uzunlikdagi)  $k$  talik *bo'sh k talik* deyiladi. To'plamda elementlarning tartibi rol

o'ynamaydi.  $k$  talikda rol o'ynaydi, to'plamda elementlar takrorlanmasligi kerak,  $k$  talikda koordinatalar takrorlanishi mumkin.

1 - misol.  $A = \{1, 2\}$ ,  $B = \{a, b, c\}$  to'plamlardan quyidagi ikkitaliklar to'plamlarini tuzish mumkin:

$$\begin{aligned} &\{(1, a), (1, b), (1, c), (2, a), (2, b), (2, c)\}, \\ &\{(a, 1), (a, 2), (b, 1), (b, 2), (c, 1), (c, 2)\}, \\ &\{(1, 1), (1, 2), (2, 1), (2, 2)\}. \end{aligned}$$

2 - misol. 1) 40 xil bolt va 13 xil gaykadan bittadan olinib necha xil juftlik tuzish mumkin?

2) 1 dan 150 gacha natural sonlar orasida 2, 5, 7 sonlaridan hech biriga bo'linmaydigani qancha?

3) 1, 2, ..., 9 raqamlaridan nechta uch xonali nomerlar tuzish mumkin?

Bu tur masalalar fan, texnika va ishlab chiqarishda ko'plab uchraydi. Ular bilan matematikaning sohalaridan biri — *kombinatorika* shug'ullanadi. Yuqoridagi kabi masalalarni yechish haqida 2-§ da alohida to'xtalamiz.



## Mashqlar

**8.1.**  $A = \{2, 3, 4, 1\}$  to'plam elementlaridan ikki xonali sonlar tuzing. Qanday  $k$  taliklar hosil bo'ladi? Ularning komponentalarini ko'rsating.

**8.2.** Uchtaliklar tengmi?

1)  $(1, \{1, 2, 3\}, 2, 3)$ ,  $(1, \{1, 2, 3\}, \{2, 3\})$ ;

2)  $(1, \{1, 2, 3\}, 2, 3)$ ,  $(1, \{2, 1, 3\}, 2, 3)$ .

**2. Ko'paytmani topish qoidasi.** Ushbu masalani qaraylik:

1 - misol. Birinchi elementi  $A = \{a, b, c\}$  to'plamdan, ikkinchi elementi esa  $B = \{2, 3\}$  to'plamdan olingan juftliklar tuzamiz. Bunday juftliklar oltita bo'ladi:

$$3 \text{ ta satr } \left\{ \begin{array}{l} (a, 2), (a, 3), \\ (b, 2), (b, 3), \\ (c, 2), (c, 3), \end{array} \right.$$

---

2 ta ustun

$A$  va  $B$  to'plamlar elementlari sonini mos ravishda  $n(A)$ ,  $n(B)$  orqali, juftliklar sonini esa  $n(A \times B)$  orqali belgilasak,  $n(A \times B) = n(A) \cdot n(B)$  ekanligini ko'ramiz.

Bu tur masalalarni yechishda quyidagi teoremadan foydalanamiz.

**Teorema.**  $A$  va  $B$  chekli to'plamlar elementlaridan tuzilgan juftliklar soni shu to'plamlar elementlari sonlarining ko'paytmasiga teng:

$$n(A \times B) = n(A) \cdot n(B). \quad (1)$$

**Isbot.**  $A = \{a_1, \dots, a_m\}$  va  $B = \{b_1, \dots, b_k\}$  bo'lsin. Ular bo'yicha quyidagi juftliklarni tuzish mumkin:

$$m \text{ ta satr } \left\{ \begin{array}{l} (a_1, b_1), \dots, (a_1, b_k), \\ \dots \\ (a_m, b_1), \dots, (a_m, b_k) \end{array} \right.$$

$k$  ta ustun

jami  $mk = n(A) \cdot n(B)$  ta juftlik tuziladi.

Umuman,  $m$  ta  $A_1, \dots, A_m$  chekli to'plamlardan tuziladigan  $m$  taliklar soni jami

$$n(A_1 \times \dots \times A_m) = n(A_1) \cdot \dots \cdot n(A_m) \quad (2)$$

ta bo'ladi.

**2 - m a s a l a .** 32 har xil harf va 10 ta turli raqamdan tarkibida oldin uch harf, ulardan keyin ikki raqam bo'ladigan nomerlardan qancha tuzish mumkin?

**Y e c h i s h .** Harflar to'plamini  $A$ , raqamlar to'plamini  $B$  orqali belgilaylik. Ulardagi elementlar soni  $n(A) = 32$ ,  $n(B) = 10$ . Talab qilinayotgan har bir nomer  $A \times A \times A \times B \times B$  beshtalik bo'ladi. (2) formula bo'yicha ularning soni

$$n(A \times A \times A \times B \times B) = 32 \cdot 32 \cdot 32 \cdot 10 \cdot 10 = 3276800 \text{ ta.}$$

Umuman, agar  $l$  talikning birinchi komponentasi  $n_1$  usul bilan tanlanishi mumkin bo'lsa, uning ixtiyoriy tanlanishida ikkinchi komponenta  $n_2$  usul bilan tanlansa, oldingi ikki komponentaning ixtiyoriy tanlanishida uchinchi komponenta  $n_3$  xil usul bilan tanlansa, umuman, to  $l$ -komponentagacha shunday qilinsa, hosil bo'ladigan  $l$  taliklar soni  $n_1 \cdot n_2 \cdot \dots \cdot n_l$  ta bo'ladi.

**3 - m a s a l a .** Nechta har xil raqamli uchtalik tuzish mumkin?

**Y e c h i s h .** Har xil raqamli uchtaliklarni tuzishda birinchi komponentani 10 xil usul bilan, har bir shunday tanlashda ikkinchi komponentani 9 xil usul bilan, oldingi ikki raqamning har bir shunday tanlashda uchinchi raqam ham 9 xil usul bilan tanlanadi. Jami bunday uchtaliklar soni  $10 \cdot 9 \cdot 9 = 810$  ta bo'ladi.



**8.3.** To'rt xil bolt va uch xil gaykadan bittadan olib necha xil juftliklar tuzish mumkin?

**8.4.** «Daftar» so'zidan undosh va unli harflarni necha xil usul bilan tanlab olish mumkin? «Qalam» so'zidan-chi?

**8.5.** 2 kitob, 3 daftar va 4 qalam bor. Ulardan bittadan olinib komplektlar tuzilmoqchi. Bu ishini necha xil usul bilan qilish mumkin?

**8.6.** Savatda 10 dona olma va 8 dona nok bor. Vali undan yo olmani, yo nokni oladi, shundan so'ng Noila qolgan mevalardan ham olma, ham nokni oladi. Bunday tanlashlar soni qancha bo'lishi mumkin? Valining qaysi tanlashida Noilaning tanlash imkoni katta bo'ladi?

### 2-§. Kombinatorikaning asosiy formulalari

**1. O'rinlashtirishlar.**  $m = 4$  ta elementli  $X = \{1, 3, 5, 7\}$  to'plam elementlaridan ikki xonali sonlar, ya'ni juftliklar tuzaylik: 13, 15, 17, 35, 37, 57, 31, 51, 71, 53, 73, 75. Bu sonlar tartiblangan qism-to'plamlardan iborat. Ular jamiining sonini  $A_4^2$  ta deb belgilaymiz (o'qilishi: «4 elementdan 2 tadan olib tuzilgan o'rinlashtirishlar soni»). Bizda  $A_4^2 = 12$  bo'lmoqda. Ixtiyoriy  $m$  uchun bu sonni hisoblash formulasini topaylik. Har qaysi juftlikning birinchi komponentasi yo 1, yo 3, yo 5, yo 7, ya'ni uni  $m = 4$  ta ixtiyoriy tanlash imkoni bor. Agar birinchi komponenta tanlangan bo'lsa, ikkinchi komponentani tanlash uchun  $m - 1 = 3$  xil tanlash imkoni qoladi. Demak, jami juftliklar soni  $A_4^2 = 4 \cdot (4 - 1)$  ta, ya'ni  $A_4^2 = 4 \cdot 3 = 12$  ta bo'ladi.

$m$  ta elementli  $X$  to'plam elementlaridan  $k$  tadan olib tuzilgan *o'rinlashtirishlar* deb,  $X$  to'plamning  $k$  uzunlikdagi tartiblangan qism-to'plamlariga aytiladi, bunda  $k \leq m$ . Ularning soni:

$$A_m^k = m(m-1)\dots(m-(k-1)). \quad (1)$$

Haqiqatan, 1- komponenta ixtiyoriy tartibda  $m$  xil tanlanadi. U holda 2- komponenta uchun  $m - 1$  xil tanlanish va hokazo oxirgi  $k$ - komponenta uchun  $m - (k - 1)$  tanlanish imkoni qoladi va bunda hech qaysi komponenta takror tanlanmaydi. Barcha  $k$

uzunlikdagi o'rinlashtirishlar soni ko'paytmani hisoblash qoidasiga muvofiq (1) formula bo'yicha topiladi.

Yuqorida qaralgan misolga qaytaylik. Lekin endi berilgan  $m = 4$  ta elementli  $X = \{1, 3, 5, 7\}$  to'plam elementlaridan komponentalari takrorlanadigan juftliklarni ham tuzish talab qilinsin. Ular:

$$\begin{pmatrix} 11 & 13 & 15 & 17 \\ 33 & 35 & 35 & 31 \\ 55 & 53 & 57 & 51 \\ 77 & 75 & 73 & 71 \end{pmatrix} \quad \text{Jami } 4 \cdot 4 = 4^2 = 16 \text{ ta juftlik.}$$

Umuman,  $m$  ta elementli  $X$  to'plam elementlaridan tuzilgan takrorlanadigan  $k$  ta komponentali  $k$  taliklar soni  $k$  ta bir xil to'plam to'plam  $X \times X \times \dots \times X$  elementlarining soniga teng (2-§, 2-band, 2-teorema). Bu son  $k$  ta  $n(X)$  ko'paytuvchi ko'paytmadan iborat:

$$n(X) \cdot n(X) \cdot \dots \cdot n(X) = (n(X))^k = m^k.$$

$m$  elementli  $X$  to'plamning elementlaridan tuzilgan va komponentalari takrorlanadigan  $k$  taliklar  $m$  elementdan  $k$  tadan olib tuzilgan *takrorli o'rinlashtirishlar* deyiladi. Ularning sonini  $\bar{A}_m^k$  orqali belgilaymiz ( $A$  harfi ustidagi chiziqcha elementlar takrorlanishi mumkinligini ko'rsatadi). Ushbu formula isbot qilindi:

$$\bar{A}_m^k = m^k. \quad (2)$$

**1 - misol.** 30 o'quvchisi bo'lgan sinfdan boshliq, yordamchi va kotib necha xil usul bilan saylanishi mumkin?

**Yechish.** Bunday ixtiyoriy saylash 30 elementdan 3 tadan olinib tuziladigan takrorsiz o'rinlashtirish, ya'ni komponentalari takrorlanmaydigan uchtalik bo'ladi. Bunday tanlash usullari soni:

$$A_{30}^3 = 30 \cdot 29 \cdot 28 = 24360 \text{ ta.}$$

**2 - misol.** 1, 2, 3, 4, 5, 6, 7, 8, 9 raqamlaridan nechta uch xonali nomerlar tuzish mumkin?

**Yechish.** Bunday nomerlar  $X = \{1, 2, 3, 4, 5, 6, 7, 8, 9\}$  to'plam elementlari qatnashadigan uchtaliklardan iborat. Ularning soni (2) formula bo'yicha  $\bar{A}_9^3 = 9^3 = 729$  ga teng.

**3 - misol.**  $n(X) = k$  va  $n(Y) = l$  bo'lsin.  $X$  to'plamni  $Y$  to'plamga akslantirishlar sonini topamiz.

**Yechish.**  $X$  to'plam elementlarini nomerlaymiz:  $X = \{x_1, \dots, x_k\}$ .  $X$  to'plamni  $Y$  ga o'tkazuvchi har qaysi  $f$  akslantirishga o'sha

elementlarning obrazlari (nusxalari)dan tuzilgan

$$(f(x_1), \dots, f(x_k))$$

$k$  talik mos. Va, aksincha,  $Y$  to'plam elementlaridan tuzilgan  $(y_1, \dots, y_k)$   $k$  talikning berilishi  $f$  akslantirishni bir qiymatli aniqlaydi:  $x_j$  element  $y_j$  ga o'tadi. Demak,  $X$  to'plamni  $Y$  to'plamga akslantirishlar soni  $Y$  to'plam elementlaridan tuzilgan  $k$  taliklar soniga teng.  $n(Y) = l$  bo'lganidan (2) formula bo'yicha bu son  $l^k$  ga teng.

4 - misol. 5 ta har xil daftarni uch bola o'rtasida necha xil usul bilan taqsimlash mumkin?

**Yechish.** Taqsimlashning har bir usuli daftarlar to'plamini bolalar to'plamiga akslantirishdan iborat. Bunday akslantirishlar soni  $3^5 = 243$ .

Umuman,  $k$  ta elementli  $X$  to'plamni  $m$  ta elementli  $Y$  to'plamga akslantirishni  $k$  ta elementni  $m$  quti bo'yicha joylashtirilishi deb tushuntirish mumkin. Bunday joylashtirishlar soni  $m^k$  ga teng bo'ladi.

5 - misol.  $\{a, b, c, d\}$  to'plamning barcha qism to'plamlarini yozamiz.

**Yechish.**  $\emptyset, \{a\}, \{b\}, \{c\}, \{d\}, \{a, b\}, \{a, c\}, \{a, d\}, \{b, c\}, \{b, d\}, \{c, d\}, \{a, b, c\}, \{a, b, d\}, \{a, c, d\}, \{b, c, d\}, \{a, b, c, d\}$ , jami 16 ta.

Bu misolda  $2^4 = 16$  bo'lmoqda. Umuman,  $k$  ta elementli to'plamning qism to'plamlari soni  $2^k$  ta bo'lishini matematik induksiya bo'yicha isbot qilish qiyin emas.



## Mashqlar

**8.7.**  $a, b, d, e, f$  harflaridan qancha uch harfli so'z tuzish mumkin? Har qaysi so'zda albatta  $b$  harfi bo'lishi talab qilinsachi?

**8.8.** Sexda 6 ishchi ishlaydi. Ulardan uch kishiga uch turli, ya'ni har bir kishiga bir xildan buyum tayyorlashni necha usul bilan topshirish mumkin?

**8.9.** 8 ta har xil kitobdan 3 tasi necha xil usul bilan tanlanishi mumkin?

**8.10.** Qo'mitaga 7 kishi saylangan. Ular orasidan rais, yordamchi, kotib necha usul bilan tanlanishi mumkin?

**8.11.** Agar har bir o'quvchiga bittadan ortiq kitob berilmasa, 6 ta kitobni 10 o'quvchiga necha xil usul bilan tarqatish mumkin?



**8.12.** 6 raqamiga ega bo'lmagan besh xonali nomerlardan qancha bo'ladi? 0 va 6 raqamiga ega bo'lmaganlari-chi?

**8.13.** 10 ta har xil detalni 3 ta qutiga necha xil usul bilan joylashtirish mumkin?

**8.14.** Komplektidagi 14 ta detaldan 4 tasida «1», 4 tasida «2», 3 tasida «3» va qolgan 3 tasida «4» belgi qo'yilgan. Komplektidan 4 ta detalni tanlab olish va ularni biror tartibda joylashtirish yo'li bilan belgilarning nechta har xil kombinatsiyasini tuzish mumkin?

**2. Takrorsiz o'rin almashtirishlar.**  $X = \{1, 3, 5\}$  to'plam bo'yicha 135, 315, 351, 153, 531, 513 o'rinlashtirishlar tuzilgan bo'lsin. Bu uchtaliklarda komponentalar takrorlanmagan, bir martadan kelgan, yozilish tartibi bilangina farq qiladi. Umuman, takrorsiz o'rinlashtirishlarda komponentalar soni  $k$  shu  $X$  to'plamning jami elementlari soni  $m$  ga teng, ya'ni  $m = k$  bo'lsa, o'rinlashtirishlar bir xil elementli bo'lib, elementlarning yozilish tartibi bilan farq qilinadigan bo'ladi. Bizning misolda ularning soni  $A_4^3 = 3 \cdot 2 \cdot 1 = 6$  ta. Ularda elementlar takrorlanmaydi, faqat o'rinlari almashadi.

$m$  ta elementdan tuzilgan takrorsiz o'rin almashtirish deb, shu elementlardan  $m$  tadan olib tuzilgan o'rin almashtirishlarga aytiladi. Ularning soni  $R_m$  orqali belgilanadi (fransuzcha *permutation* — o'rin almashtirish). Ta'rif bo'yicha

$$P_m = A_m^m, \text{ yoki } P_m = m(m-1)\dots(m-m+1) = m(m-1) \cdot \dots \cdot 1 = m!, \text{ yoki } P_m = m! \quad (1)$$

1 - misol. 3 detalni 3 qutiga necha xil tartibda joylashtirish mumkin?

**Yechish.** Detallarni  $x_1, x_2, x_3$  orqali, qutilarni 1, 2, 3 orqali belgilaylik. Natijada  $(x_1, x_2, x_3), (x_1, x_3, x_2), (x_2, x_1, x_3), (x_2, x_3, x_1), (x_3, x_1, x_2), (x_3, x_2, x_1)$  o'rin almashtirishlar olinadi. Ularning soni  $R_3 = 3 \cdot 2 \cdot 1 = 6$  ta.



## Mashqlar

**8.15.** 7 xil kitobni 7 o'quvchiga necha usul bilan tarqatish mumkin?

**8.16.** Hech qanday ikki komanda bir xil ochko olmagan bo'lsa, 8 komandani turnir jadvaliga necha usul bilan joylashtirish mumkin?

**8.17.** Qutiga 6 xil  $A, B, D, E, F, G$  detal ketma-ket joylashtirilishi kerak. Agar  $B$  ning  $A$  dan oldin joylashtirilishi mumkin bo'lmasa, unda detallar necha xil usul bilan joylashtirilishi mumkin? Agar  $B$  detal  $A$  dan keyin joylashtirilishi talab qilinsachi?

**3. Takrorsiz kombinatsiyalar.** Endi  $X$  to'plam elementlaridan  $k$  taliklar emas, balki qism-to'plamlar tuzaylik. Ular o'z tarkiblaridagi elementlari bilan bir-birlaridan farq qiladi. Masalan,  $X = \{a, b, d, e, f\}$  to'plam bo'yicha tuzilgan  $k = 3$  ta elementli  $\{a, d, f\}, \{a, e, f\}, \{b, d, e\}$  uchtaliklar biz aytayotgan qism to'plamlardandir.

$m$  ta elementli  $X$  to'plamning  $k$  ta elementli qism to'plamlari shu elementlardan  $k$  tadan olib tuzilgan *takrorsiz kombinatsiyalar* deyiladi. Ularning sonini  $C_m^k$  orqali ko'rsatamiz (fransuzcha *combination* – kombinatsiya).

I - m i s o l .  $\{a, b, d, e, f\}$  to'plam bo'yicha har birida uchtdan har xil element bo'lgan 10 ta kombinatsiya tuzish mumkin:  $\{a, b, d\}, \{a, b, e\}, \{a, b, f\}, \{a, d, e\}, \{a, d, f\}, \{a, e, f\}, \{b, d, e\}, \{b, e, f\}, \{b, d, f\}, \{d, e, f\}$ .

Kombinatsiyalar sonini hisoblash formulasini chiqaraylik. Yuqoridagi misolda ko'rsatilganicha berilgan 5 elementdan 3 tadan olib jami 10 kombinatsiya hosil qilinadi. Lekin har bir kombinatsiyadan oltitadan o'rin almashtirish tuzish mumkin. Masalan, bitta  $\{a, b, d\}$  kombinatsiyadan  $(a, b, d), (a, d, b), (b, a, d), (b, d, a), (d, a, b), (d, b, a)$ , jami oltita o'rin almashtirish hosil bo'ladi. Bunga qaraganda jami 5 elementdan uchtdan olib tuzilgan takrorsiz o'rinashtirishlar soni  $6 \cdot 10 = 60$  ta, ya'ni VIII bob, 2-§, (1) formulaga asosan  $A_5^3 = 5 \cdot 4 \cdot 3 = 60$  ta bo'ladi. Biz  $A_5^3 = C_5^3 \cdot 3!$  ga ega bo'lamiz. Bundan  $C_5^3$  topiladi.

Umuman,  $m$  elementdan  $k$  tadan olib tuzilgan o'rinashtirishlar soni  $A_m^k = k! C_m^k$  bo'ladi, bundan kombinatsiyalar soni uchun ushbu formulalar olinadi:

$$C_m^k = \frac{A_m^k}{k!} = \frac{m(m-1)\dots(m-k+1)}{1 \cdot 2 \cdot 3 \dots k} \quad (1)$$

yoki



VIII.1-rasm.

$$C_m^k = \frac{m!}{k!(m-k)!}. \quad (2)$$

2 - misol. 20 o'quvchidan 3 kishilik qo'mitani necha usul bilan tanlash mumkin?

Yechish. Tanlashlar soni:  $C_{20}^3 = \frac{20 \cdot 19 \cdot 18}{1 \cdot 2 \cdot 3} = 1140$ .

3 - misol.  $k$  ta  $a$  harfiga va  $n$  ta  $b$  harfiga ega bo'ladigan  $k+n$  taliklar sonini topamiz.

Yechish.  $k+n$  taliklar tarkibi ma'lum. Ular harflarning tartibi bilangina bir-biridan farq qiladi. Bu tartib  $a$  harflari turgan o'rinlarni ko'rsatish bilan bir qiymatli aniqlanadi (chunki qolgan o'rinlarni  $b$  lar egallaydi). Boshqacha aytganda, o'rinlarning  $(k+n)$  ta elementli to'plamida  $k$  ta elementli ( $k$  uzunlikdagi) qism to'plam tanlanishi kerak. Bu esa  $C_{k+n}^k$  usul bilan qilinish mumkin.

4 - misol.  $AB$  kesmada  $C, D, E$  nuqtalar belgilangan (VIII.1-rasm). Jami nechta kesma hosil bo'ladi? (bunga  $AB$  kesma ham kiradi).

Yechish. Nuqtalar soni 5 ta. Har ikki nuqta izlanayotgan kesmalardan birini beradi. Bunda ikki nuqtaning yozilish tartibi rol o'ynamaydi. Masalan,  $AC$  va  $CA$  - bitta kesma. Shunday qilib,  $\{A, B, C, D, E\}$  to'plamning ikki elementli qism to'plamlari sonini aniqlashimiz kerak. Ular  $C_5^2 = \frac{5 \cdot 4}{1 \cdot 2} = 10$  ta.

Binomial koeffitsiyentlarning ayrim xossalarini keltiramiz:

1)  $(x+a)^m$  binom yoyilmasida har qaysi  $x^{m-k}a^k$  ifoda oldida turgan koeffitsiyent  $C_m^k$  kombinatsiyalar soniga teng. Haqiqatan, agar  $(x+a)^m = (x+a)(x+a) \cdot \dots \cdot (x+a)$  ( $m$  ta ko'paytuvchi) ko'paytmadagi qavslar daraja ko'rsatkichlaridan foydalanilmay va ko'paytuvchilarni o'rin almashtirmay ochilsa, natijada  $x$  va  $a$  harflaridan tuzilgan  $m$  uzunlikdagi barcha  $m$  taliklarning yig'indisi hosil bo'lar edi. Masalan,

$$\begin{aligned} (x+a)^3 &= (x+a)(x+a)(x+a) = \\ &= xxx + xxa + xax + xaa + axx + axa + aax + aaa. \end{aligned}$$

Qo'shiluvchilardan, masalan,  $k=2$  ta  $a$  harfiga va  $m-k=3-2=1$  ta  $x$  harfiga ega bo'ladiganlarini sanasak, ular 3 ta. Bu esa (1) formula bo'yicha hisoblab topilganiga teng:  $C_3^2 = \frac{3 \cdot 2}{1 \cdot 2} = 3$ .

Umuman, yoyilma tarkibida  $x^{m-k}a^k$  ga ega bo'lgan hadiga

o'xshash, ya'ni  $m - k$  ta  $x$  harfiga va  $k$  ta  $a$  harfiga ega bo'lgan  $m$  taliklar soni  $C_{(m-k)+k}^k$  ga, ya'ni  $C_m^k$  ga teng. Shunday qilib,

$$(x+a)^m = C_m^0 x^m + C_m^1 x^{m-1} a + \dots + C_m^k x^{m-k} a^k + \dots + C_m^m a^m \quad (3)$$

bo'ladi.

2) Agar (3) yoyilmaga  $x = a$  ni qo'ysak, quyidagi hosil bo'ladi:

$$C_m^0 + C_m^1 + \dots + C_m^k + \dots + C_m^m = 2^m. \quad (4)$$

3) Agar (2) tenglikdan foydalansak:

$$C_m^{m-k} = \frac{m!}{(m-k)!(m-(m-k))!} = \frac{m!}{(m-k)!k!} = C_m^k, \quad C_m^{m-k} = C_m^k. \quad (5)$$



## Mashqlar

**8.18.** 20 kishi ichidan 4 vakilni necha usul bilan saylash mumkin?

**8.19.** Bir aylanada yotgan 5 ta nuqta ustidan nechta vatar o'tkazish mumkin?

**8.20.** Bir kishida 10 ta kitob, ikkinchisida 12 ta kitob bor. Almashtirish uchun ularning har biri necha usul bilan 3 tadan kitob tanlashlari mumkin?

**8.21.** Lotereya biletidagi 49 nomerdan 5 tasini necha xil usul bilan o'chirish mumkin? Necha holda tanlangan 5 ta nomerdan uchtasi tirajdan keyin topilgan bo'ladi? Necha holda 5 ta nomer to'g'ri topilgan bo'ladi?

**8.22.** Binom yoyilmasi va Muavr formulalaridan foydalanib, ayniyatlar isbot qilinsin:

$$1) S = C_n^1 - 3C_n^3 + 3^2 C_n^5 - 3^3 C_n^7 + \dots = \frac{2}{\sqrt{3}} \sin \frac{n\pi}{3};$$

$$2) 2^{n-1} = 1 + C_n^2 + C_n^4 + \dots = C_n^1 + C_n^3 + \dots;$$

$$3) C_n^0 + C_n^1 \cos \varphi + C_n^2 \cos 2\varphi + \dots + C_n^n \cos n\varphi = 2^n \cos^n \frac{\varphi}{2} \cos \frac{n\varphi}{2}.$$

**4. Takrorli o'rin almashtirishlar.** Jami  $k = 3$  ta  $a_1, a_2, a_3$  elementdan  $P_k = P_3 = 3! = 6$  ta o'rin almashtirishlar tuzish mumkinligini bilamiz:

$$(a_1, a_2, a_3), (a_1, a_3, a_2), (a_2, a_1, a_3),$$

$$(a_2, a_3, a_1), (a_3, a_1, a_2), (a_3, a_2, a_1).$$

Bu uchtaliklarda har bir element faqat bir martadan qatnashmoqda:  $k_1 = k_2 = k_3 = 1$ . Endi shu elementlardan  $(a_1, a_1, a_1, a_2, a_3, a_3)$ ,  $(a_1, a_2, a_3, a_1, a_1, a_3)$  otiliklar tuzilgan bo'lsin. Bular ham faqat elementlarning tartibi bilangina farq qiluvchi o'rin almashtirishlardan iborat. Lekin bu holda  $a_1$  element  $k_1 = 3$  marta,  $a_2$  element  $k_2 = 1$  marta,  $a_3$  element  $k_3 = 2$  marta takrorlanmoqda va  $k = k_1 + k_2 + k_3 = 6$ . O'rin almashtirishlarni yozishni yana davom ettirish mumkin. Ularning sonini  $P(k_1, k_2, k_3)$ , ya'ni  $R(3, 1, 2)$  orqali belgilaylik, bunda  $(3, 1, 2)$  yozuv oltitaliklar tarkibida  $a_1$  element 3 marta,  $a_2$  element 1 marta,  $a_3$  element 2 marta takrorlanishini ko'rsatadi.  $P(3, 2, 1)$  takrorli o'rin almashtirishlar sonini topish talab qilinsin.

Ta'rif. *Takrorli o'rin almashtirish* deb, tarkibida  $a_1$  harfi  $k_1$  marta, ...,  $a_m$  harfi  $k_m$  marta qatnashuvchi  $k = k_1 + k_2 + \dots + k_m$  uzunlikdagi har qanday  $k$  talikka aytiladi. Takrorli o'rin almash-tirishlar sonini  $P(k_1, \dots, k_m)$  orqali belgilanadi.

$P(3, 1, 2)$  sonini topishning yo'llaridan biri o'sha oltitalik-larning hammasini tuzish va sanash. Lekin  $a_j$  komponentalar soni va  $k_j$  takrorlanishlar ko'p bo'lsa, bu yo'l noqulaydir. Umuman,  $P(k_1, \dots, k_m)$  ni hisoblash uchun formula kerak bo'ladi.

$k$  talik tarkibida  $k_1$  ta o'ringa  $a_1$  harfini  $C_k^{k_1}$  usul bilan o'rin almashtirish orqali yozish mumkin. U holda qolgan  $k - k_1$  ta o'ringa  $a_2$  ni  $C_{k-k_1}^{k_2}$  usul bilan o'rin almashtirib yoziladi. Shu kabi,  $a_3$  ni  $C_{k-k_1-k_2}^{k_3}$ , ...,  $a_m$  ni  $C_{k-k_1-\dots-k_{m-1}}^{k_m}$  usul bilan o'rin almash-tirib yozish mumkin.

Jami o'rin almashtirishlar soni ko'paytirish qoidasiga muvofiq,

$$P(k_1, \dots, k_m) = C_k^{k_1} \cdot C_{k-k_1}^{k_2} \cdot \dots \cdot C_{k-k_1-\dots-k_{m-1}}^{k_m}$$

ta bo'ladi. Topilgan munosabatni soddalashtiraylik. Shu maqsadda

$C_k^j = \frac{k!}{j!(k-j)!}$  formuladan foydalanamiz. Natijada

$$P(k_1, \dots, k_m) = \frac{k!}{k_1!(k-k_1)!} \cdot \frac{(k-k_1)!}{k_2!(k-k_1-k_2)!} \cdot \dots \cdot \frac{(k-k_1-\dots-k_{m-1})!}{k_m!(k-k_1-\dots-k_m)!},$$

bunda  $(k - k_1 - \dots - k_m)! = 0! = 1!$  yoki qisqartirishlardan so'ng

$$P(k_1, \dots, k_m) = \frac{k!}{k_1! \cdot k_2! \cdot \dots \cdot k_m!}, \quad (1)$$

bunda  $k = k_1 + k_2 + \dots + k_m$ .

Takrorsiz o'rin almashtirishlar (1) formulaning  $k_1 = k_2 = \dots = k_m = 1$  bo'lgan xususiy holdir.

1 - misol. Bandning boshida qaralgan misolda talab qilingan barcha otiliklar soni:

$$P(3, 1, 2) = \frac{6!}{3! \cdot 1! \cdot 2!} = 60.$$

2 - misol. 30 ta detalni 5 ta har xil qutiga 6 tadan necha xil usul bilan joylashtirish mumkin?

Yechish. Masalaning shartiga ko'ra  $k = 30$ ,  $k_1 = k_2 = \dots = k_5 = 6$ ,  $m = 5$ . (1) formula bo'yicha usullar soni:

$$P(6, 6, 6, 6, 6) = \frac{30!}{6! \cdot 6! \cdot 6! \cdot 6! \cdot 6!}.$$

3 - misol. Yuqoridagi misolda qutilar bir xil bo'lsa-chi?

Yechish. Qutilar har xil bo'lganda oldingi misol natijasiga

ko'ra jami o'rin almashtirishlar soni  $P(6, 6, 6, 6, 6) = \frac{30!}{(6!)^5}$  ta edi. Qutilar bir xil bo'lsa, qutilarni almashtirish detallarni joylashtirish usullari soniga ta'sir qilmaydi. Bunga qaraganda joylashtirish usullari soni  $5!$  marta kamayadi.

$$\text{Javob: } \frac{1}{5!} P(6, 6, 6, 6, 6) = \frac{30!}{5(6!)^5}.$$

4 - misol. «Raketa» so'zida harflar o'rni almashtirilsa, nechta «so'z» hosil bo'lishi mumkin?

Yechish. Ikki hol bo'lishi mumkin:

1 - hol. «a» harfi  $k_2 = 2$  marta takrorlanmoqda. Ulardan biri ikkinchisi bilan o'rin almashganda «so'z» o'zgarmay qolaveradi. Shu sababli hosil bo'ladigan «so'z»lar soni takrorli o'rin almashtirishlar soni uchun yuqorida chiqarilgan (1) formula bo'yicha topiladi:

$$P(1, 2, 1, 1, 1) = \frac{6!}{1! \cdot 2! \cdot 1! \cdot 1! \cdot 1!} = 360.$$

2 - hol. Hosil bo'ladigan «so'z»larda harflar faqat bir martadan qatnashsa, ya'ni takrorlanmasa, buning uchun, masalan, ikkala „a“ harfi ikkita alohida olingan element deb qabul qilinsa, takrorsiz o'rin almashtirishlarga ega bo'lamiz. Bu holda ularning soni 2-band, (1) formula bo'yicha hisoblanadi:

$$P = 6! = 1 \cdot 2 \cdot 3 \cdot 4 \cdot 5 \cdot 6 = 720.$$

Izlanayotgan sonni (1) formula bo'yicha ham topish mumkin edi:

$$P(1, 1, 1, 1, 1, 1) = \frac{6!}{1! \cdot 1! \cdot 1! \cdot 1! \cdot 1! \cdot 1!} = 720.$$

Takrorsiz o'rin almashtirishlar soni uchun 2-band, (1) formula ushbu bandeda chiqarilgan (1) formulaning xususiy holidan iborat.

(1) formula bo'yicha  $P(m-k, k) = \frac{m!}{(m-k)! \cdot k!} = C_m^k$  bo'ladi. Bu tenglikdan foydalanib, Nyuton binomi formulasini quyidagicha yozamiz:

$(x+a)^m = P(m, 0)x^m + P(m-1, 1)x^{m-1}a + \dots + P(0, m)a^m$ ,  
yoki

$$(x+a)^m = \sum_{k=0}^m P(m-k, k)x^{m-k}a^k, \quad (2)$$

yoki, umuman:

$$(x_1 + x_2 + \dots + x_t)^k = \sum P(k_1, \dots, k_t)x_1^{k_1} \dots x_t^{k_t}, \quad (3)$$

bunda  $k$  va  $t$  - ixtiyoriy sonlar,  $k_1 + \dots + k_t = k$  - nomanfiy butun sonlar yig'indisi, xususan,  $x_1 = x_2 = \dots = 1$  da  $t^k = \sum P(k_1, \dots, k_t)$  bo'ladi.

5 - misol. 1)  $(a+b+c)^2$ ; 2)  $(a+b+c)^3$ ; 3)  $(a+b+c)^4$  ifodalarni (3) formuladan foydalanib yoyamiz.

1)  $(a+b+c)^2 = \sum P(k_1, k_2, k_3)a^{k_1}b^{k_2}c^{k_3}$ , bunda yig'indi barcha  $(k_1, k_2, k_3)$  uchtaliklarga nisbatan tuziladi va  $k = k_1 + k_2 + k_3 = 2$ . Uchtaliklar:

$(2, 0, 0), (0, 2, 0), (0, 0, 2), (1, 1, 0), (1, 0, 1), (0, 1, 1)$ .

Ulardagi takrorlanishlar soni:

$$P(0, 0, 2) = P(0, 2, 0) = P(2, 0, 0) = \frac{2!}{0! \cdot 0! \cdot 2!} = 1,$$

$$P(1, 1, 0) = P(1, 0, 1) = P(0, 1, 1) = \frac{2!}{1! \cdot 1! \cdot 0!} = 2.$$

Natijada ifoda ushbu ko'rinishga keladi:

$$(a+b+c)^2 = a^2 + b^2 + c^2 + 2ab + 2ac + 2bc.$$

2) Yechish yuqorida ko'rsatilganidek. Bunda  $k = k_1 + k_2 + k_3 = 3$ . Uchtaliklar:

$(3, 0, 0), (0, 3, 0), (0, 0, 3), (2, 1, 0), (2, 0, 1), (1, 2, 0), (1, 0, 2),$   
 $(0, 1, 2), (0, 2, 1), (1, 1, 1)$ .



Ulardagi takrorlanishlar soni:

$$P(0, 0, 3) = P(0, 3, 0) = P(3, 0, 0) = \frac{3!}{0! \cdot 0! \cdot 3!} = 1,$$

$$P(2, 1, 0) = P(2, 0, 1) = P(1, 2, 0) = P(1, 0, 2) = \\ = P(0, 1, 2) = P(0, 2, 1) = \frac{3!}{2! \cdot 1! \cdot 0!} = 3,$$

$$P(1, 1, 1) = \frac{3!}{1! \cdot 1! \cdot 1!} = 6.$$

Natijada:

$$(a+b+c)^3 = a^3 + b^3 + c^3 + 3a^2b + 3a^2c + 3ab^2 + 3ac^2 + 3bc^2 + 3b^2c + 6abc.$$

3)  $k = k_1 + k_2 + k_3 = 4$ . Uchtaliklar:

(4, 0, 0), ..., (3, 1, 0), ..., (2, 2, 0), ..., (2, 1, 1), ..., (1, 1, 2).

Uchtaliklarning takrorlanishlari soni:

$$P(4, 0, 0) = \dots = P(0, 0, 4) = \frac{4!}{4! \cdot 0! \cdot 0!} = 1, \quad P(3, 1, 0) = \dots = \frac{4!}{3! \cdot 1! \cdot 0!} = 4,$$

$$P(2, 2, 0) = \dots = \frac{4!}{2! \cdot 2! \cdot 0!} = 6, \quad P(2, 1, 1) = \dots = \frac{4!}{2! \cdot 1! \cdot 1!} = 12$$

va natijada:

$$(a+b+c)^4 = a^4 + b^4 + c^4 + 4a^3b + 4a^3c + 4b^3a + 4b^3c + 4ac^3 + \\ + 4bc^3 + 6a^2b^2 + 6a^2c^2 + 6b^2c^2 + 12a^2bc + 12ab^2c + 12abc^2.$$



## Mashqlar

**8.23.** «Uchburchak» soʻzidagi harflarni oʻrin almashtirib, nechta soʻz hosil qilish mumkin? «Almashtirish» soʻzidagini-chi? «Kombinatorika» soʻzidagini-chi?

**8.24.** Oʻquvchining 3 ta koʻk, 4 ta qora, 5 ta qizil qalami bor. Ulardan faqat bittasini necha xil usul bilan tanlashi mumkin?

**8.25.** Mukofot uchun bir kitobdan 4 dona, ikkinchisidan 3 dona, uchinchisidan 6 dona ajratilgan. Agar har kishiga bittadan ortiq kitob berilmaydigan boʻlsa, bu mukofotni 30 kishi oʻrtasida necha xil usul bilan taqsimlash mumkin?

**8.26.** «Aylana» soʻzidagi «a» harfi qatorasiga uch marta kelmaydigan qilinib, necha xil usul bilan oʻrin almashtirish mumkin?

**8.27.** «Trigonometriya» soʻzidagi harflarni «o» harfi qatorasiga ikki marta kelmaydigan qilib, necha xil usul bilan oʻrin almashtirish mumkin?



8.28. 1)  $(a + b + c)^4$ ; 2)  $(a + b + c + d)^5$  yoyilmasidagi hadlar sonini toping va biror hadini yozing.

8.29. 1)  $(a + b + c)^8$ ; 2)  $(a + b + c + d)^{10}$  yoyilmasidagi eng katta koeffitsiyentni toping.

8.30.  $(1 + x + 2x^2)^8$  yoyilmasida  $x^6$  oldidagi koeffitsiyentni toping.

**5. Takrorli kombinatsiyalar.** Elementlari soni  $m = 2$  ta bo'lgan  $M\{a, b\}$  to'plam berilgan.  $a$  dan  $k_1$  ta,  $b$  dan  $k_2$  ta, jami  $k = k_1 + k_2 = 4$  ta olinib, elementlari bilan farq qiluvchi to'rttaliklar tuzaylik:

$(a, a, a, a)$ , bunda  $k_1 = 4, k_2 = 0$ , ya'ni tarkibi (4;0) ikkilik,

$(a, a, a, b)$ , bunda  $k_1 = 3, k_2 = 1$ , ya'ni tarkibi (3;1) ikkilik,

$(a, a, b, b)$ , bunda  $k_1 = 2, k_2 = 2$ , ya'ni tarkibi (2;2) ikkilik,

$(a, b, b, b)$ , bunda  $k_1 = 1, k_2 = 3$ , ya'ni tarkibi (1;3) ikkilik,

$(b, b, b, b)$ , bunda  $k_1 = 0, k_2 = 4$ , ya'ni tarkibi (0;4) ikkilik,

bunda elementlar tartibi rol o'ynamasin. Shunga ko'ra, masalan,  $(a, a, a, a) = (a, a, a, b) = \dots$  deb qabul qilinadi. Biz elementlari takrorlangan kombinatsiyalarga ega bo'lamiz. Ularning sonini  $\bar{C}_m^k$

orqali belgilaylik. Bizda  $\bar{C}_2^4 = 5$  bo'lmoqda. Bu sonni hisoblash yo'lini topish maqsadida to'rttalik tarkibidagi  $k_1$  va  $k_2$  sonlarini 1, vergullarni 0 orqali almashtiraylik. Masalan, tarkibi (3; 1) bo'lgan ikkitalik bo'yicha (1, 1, 1, 0, 1) beshtalikni hosil qilamiz, unda  $k = 4$  ta 1,  $m - 1 = 2 - 1 = 1$  ta 0 ishtirok etadi. Har qaysi beshtalikka aynan bitta ikkitalik mos va, aksincha, har qaysi ikkitalikka bitta beshtalik mos. Shunga ko'ra izlanayotgan ikkitaliklar soni  $k = 4$  ta 1 lar va  $m - 1 = 1$  ta 0 dan tuzilgan beshtaliklar soniga teng. Takrorli o'rin almashtirishlar formulasi bo'yicha bunday beshtaliklar soni  $P(4; 1) = \frac{(4+2-1)!}{4! \cdot 1!} = \frac{5!}{4!} = 5$ .

$m$  xil elementdan  $k$  tadan olinib, shunday  $k$  taliklar tuzilishi kerak bo'lsin-ki, ular hech bo'lmasa bir elementi bilan farq qilsin, bir xil elementlardan tuzilganlari esa teng hisoblansin (elementlarning tartibi ahamiyatsizdir). Bunday  $k$  taliklarga  $m$  elementdan  $k$  tadan olib tuzilgan *takrorli kombinatsiyalar* deyiladi. Ularning soni  $\bar{C}_m^k$  orqali belgilanadi. Shu sonni topaylik.

Kombinatsiyaning har qanday tarkibi nomanfiy butun sonlardan tuzilgan  $m$  talik  $(k_1, k_2, \dots, k_m)$  bilan beriladi va bundagi  $k_1$  son kombinatsiyadagi birinchi xil elementning,  $k_2$  ikkinchi xil elementning, ...,  $k_m$   $m$ -xil elementning sonini ko'rsatadi. Shunday qilib,  $\bar{C}_m^k$  son  $m$  uzunlikdagi  $(k_1, k_2, \dots, k_m)$  sonli  $m$  talikdagi

har qaysi  $k_i$  sonni  $k_i$  ta 1 lar ketma-ketligi bilan, har qaysi vergulni 0 bilan almashtiramiz (agar  $k_i = 0$  bo'lsa, 1 lar yozilmaydi). Natijada  $k_1 + k_2 + \dots + k_m = k$  ta 1 lar va  $m - 1$  ta 0 dan iborat  $k + m - 1$  talik hosil bo'ladi (bundagi barcha  $k_i$  lar nomanfiy butun sonlardan iborat). Ularning har birida vergullar sonlarga nisbatan bitta kam bo'lishi tushunarli. Masalan, (4, 1, 0, 2) to'rttalikka (1, 1, 1, 1, 0, 1, 0, 0, 1, 1) o'ntalik mos. Shunday qilib, izlanayotgan  $m$  talik ( $k_1, k_2, \dots, k_m$ ) lar soni  $k$  ta 1 lar va  $m - 1$  ta 0 dan tuzilgan  $k + m - 1$  liklar soniga teng bo'ladi. Takrorli o'rin almashtirishlar formulasi bo'yicha bunday  $k + m - 1$  taliklar soni

$$P(k, m-1) = \frac{(k+m-1)!}{k!(m-1)!}$$

ga teng, ya'ni

$$\bar{C}_m^k = C_{k+m-1}^k \quad (1)$$

**Misol.** 4 xil kitobdan necha usul bilan 7 kitobdan iborat to'plam yozish mumkin?

**Yechish.** Izlanayotgan son  $\bar{C}_4^7$  ga yoki  $C_{7+4-1}^7$  ga teng. Jami  $C_{10}^7 = C_{10}^3 = \frac{10 \cdot 9 \cdot 8}{1 \cdot 2 \cdot 3} = 120$  to'p.



## Mashqlar

**8.31.** Savdoda 5 xil qalam bor. Ulardan 8 ta qalamni necha xil usul bilan olish mumkin? 6 tasini-chi? 4 tasini-chi?

**8.32.** Tomonlari 3, 4, 5, 6 sm bo'la oladigan uchburchaklardan nechta yasash mumkin?

## Takrorlashga doir mashqlar

**8.33.** 8 olma, 4 ta nok va 8 ta shaftolidan necha xil usul bilan bir necha meva tanlab olinishi mumkin (bir turdagi mevalar bir-biridan farq qilinmaydi)?

**8.34.** Ikkita «a», uchta «o» va sakkizta «v» harfidan nechta bittadan kam bo'lmagan harfga ega «so'z»lar tuzish mumkin?

**8.35.** 12 ta har xil detalni uch qutiga joylashtirmoqdalar. Bunda birinchi qutiga 3 ta detal, ikkinchisiga 5 ta detal, uchinchisiga qolgan detallarning hammasi joylashtirilishi kerak. Bu ishni necha usul bilan qilish mumkin?

**8.36.** 16 o'quvchiga kitob tarqatilishi kerak. 10 ta birinchi xil, 6 ta ikkinchi xil kitob bor. Lekin o'quvchilardan 4 tasiga 1-xil kitob, 5 tasiga 2-xil kitob kerak emas. Agar: 1) o'quvchilarga kitoblarning qanday xilini berish tartibi e'tiborga olinmasa; 2) ham 1-xil, ham 2-xil kitobni berish tartibi e'tiborga olinsa; 3) faqat 1-xil kitobni berish tartibi e'tiborga olinsa, o'quvchilarga kitob necha xil usul bilan berilishi mumkin?

**8.37.** Agar har qaysi son ikkita juft va uchta toq raqamdan iborat bo'lib, unda hech qaysi ikki raqam takrorlanmasa, 1, 2, 3, 4, 5, 6, 7, 8, 9 raqamlaridan qancha besh xonali sonlarni tuzish mumkin?

**8.38.** 5 kishi ingliz tilini, 6 kishi fransuz tilini biladi. Ulardan birinchi guruhga 3 ingliz, ikkinchisiga 4 fransuz tilini biluvchi kirishi kerak, uchinchi guruh esa uch kishidan iborat bo'lib, ular ingliz tilini ham, fransuz tilini ham biluvchi bo'lishi mumkin. Bunday guruhlar necha turli usul bilan tuzilishi mumkin?

**8.39.** O'n qutiga 10 detal bittadan, shu jumladan 1-xil detallardan 2 ta joylashtirilishi kerak. Joylashtirishlarni necha turli usul bilan 1-xil detallar ketma-ket kelmaydigan qilib bajarish mumkin?

**8.40.** 6 ta oq va 9 ta ko'k marka bor. Necha turli usul bilan 3 ta oq va 3 ta ko'k markani 6 ta nomerlangan joyga yopishtirish mumkin?

**8.41.** Qavariq  $n$  burchakda diagonallarining hech qanday uchtasi bir nuqtada kesishmasa, qolgan hollarda diagonallar qancha nuqtada kesishadi?

**8.42.** 1, 3, 5, 7, 9 toq raqamlardan tuziladigan va har birida bu raqamlar takrorlanmaydigan to'rt xonali sonlardan nechta tuzish mumkin?

**8.43.** 8.42-mashqda raqamlarning takrorlanishi mumkin bo'lsa-chi?

**8.44.** 8.42-mashqda agar tuziladigan to'rt xonali sonda ikkitadan ortiq bir xil raqam bo'lmasligi talab etilsa-chi?

**8.45.** 8.42-mashqda tuziladigan to'rt xonali son 2000 dan katta bo'lmasligi talab qilinsa-chi?

**8.46.** «Rohat» so'zi harflaridan besh harfli nechta har xil «so'z» tuzish mumkin («so'z» deganda harflarning istalgan ketma-ketligi tushuniladi)?

**8.47.** «Traktor» soʻzining harflaridan yetti harfli nechta har xil «soʻz» tuzish mumkin?

**8.48.** Birinchi oʻrinda 3 raqami, ikkinchi, uchinchi, toʻrtinchi va beshinchi oʻrinlarda 0, 1, 2, 3, ..., 9 raqamlaridan istalgan biri turadigan telefon nomerlaridan nechta tuzish mumkin?

**8.49.** Toʻrt qutiga 4 tadan detal va bir qutiga 5 detal tushadigan qilinib, 21 ta detalni 5 qutiga necha turli xil usul bilan joylashtirish mumkin?

**8.50.** «Beshburchak» soʻzidagi harflarni necha usul bilan oʻrin almashtirib, unli harflarni alfavit tartibida joylashtirish mumkin?

**8.51.** «Choʻpon» soʻzidagi harflar necha xil oʻrin almashtirilib, ikki unli harf oʻrtasiga ikki undosh harf kelishi mumkin?

**8.52.** «Topologiya» soʻzidagi harflarni necha usul bilan oʻrin almashtirib, ikkita «o» harfi qatorasiga (yonma-yon) turmaydigan qilish mumkin?

**8.53.** «Marmar» soʻzidagi harflarni necha usul bilan almashirilib, ikkita bir xil harf ketma-ket kelmaydigan qilish mumkin?

**8.54.** 8 ta «a» va 8 ta «b» harfini necha usul bilan bir qatorga joylashtirib, ixtiyoriy  $k \leq 16$  uchun oldingi  $k$  ta harflar orasida «b» harfiga qaraganda kam boʻlmaydigan qilish mumkin?

**8.55.** 33 ta harfli alifboda toʻrttadan har xil harf olinib, qancha «soʻz» tuzish mumkin?

**8.56.** Tenglamalarni yeching:

$$a) \frac{C_{2x}^{x+1}}{C_{2x+1}^{x-1}} = \frac{2}{3}, \quad x \in N; \quad b) A_{x-1}^2 - C_x^1 = 79, \quad x \in N.$$

**8.57.** Tenglamani yeching:  $3C_{x+1}^2 - 2A_x^2 = 1,5x, \quad x \in N.$

**8.58.** Tengsizlikni yeching:  $C_{13}^m < C_{13}^{m+2}, \quad m \in N.$

**8.59.** Tengsizlikni yeching:  $5C_n^3 < C_{n+2}^4, \quad n \in N.$

**8.60.** a)  $x_n < C_{n+5}^4 - \frac{143}{96} \cdot \frac{P_{n+5}}{P_{n+3}}, \quad n \in N$  ketma-ketlikning manfiy hadlari nechta?

b)  $x_n = \frac{195}{4P_n} - \frac{A_{n+3}^3}{P_{n+1}}, \quad n \in N$  ketma-ketlikning musbat hadlari nechta?



# IX BOB

## EHTIMOLLIK NAZARIYASI VA MATEMATIK STATISTIKA ELEMENTLARI

---

### 1-§. Ehtimollikni hisoblash

**1. Ehtimollik nazariyasi nimani o'rganadi?** Kishi moddiy dunyoda ro'y beradigan hodisalarni kuzatar ekan, ko'pincha uni shu *hodisalarning* ro'y berish-bermasligi ham qiziqtiradi. Biz hozircha *natijasini* oldindan aytish mumkin bo'lgan tabiiy va ishlab chiqarishga oid turli jarayonlar, holatlar va ularning ro'y berish qonuniyatlari bilan tanishib keldik. Hayotda esa ro'y berish-bermasligini oldindan aytib bo'lmaydigan, ya'ni *tasodifan ro'y beradigan hodisalar*, qisqacha, *tasodifiy hodisalar* ham uchraydi. Lotereya o'yinida yutuq chiqishi, bir marta otilgan o'qning nishonga tegishi, tayyorlangan buyum sinalganda standartli bo'lib chiqishi — eng sodda tasodifiy hodisalar. Shu bilan birga amaliyot nuqtayi nazaridan alohida olingan hodisalar emas, balki yetarlicha ko'p sonli, *ommaviy xarakterga ega* hodisalarning umumiy qonuniyatlarini o'rganish muhimroq. Masalan, korxonada uchun bitta-ikkita buyum emas, balki ko'plab tayyorlangan buyumlardan qanchasi yaroqli yoki yaroqsiz bo'lishini, bir va bir necha urug' emas, balki katta maydonlardagi ekinning qancha qismi unib chiqishini bilish muhim.

Yuqorida ko'rsatilgani kabi aniq shartlar qo'yilib, sifatini tekshirishlar, sodir bo'lish-bo'lmaslikni sinab-hisoblab ko'rishlar, o'yin o'tkazishlar, o'q otilishi va hokazo qisqacha *tajriba* o'tkazildi. *sinaldi* deyiladi. Tajriba *natijasi* esa hodisadir. Odatda katta hajmdagi masalalarni yechish kerak bo'lsa, ma'lum shartlar qo'yilib, *bir xil* tajriba, sinashlar o'tkaziladi va ularning natijalari o'rganiladi. Tajribalar soni mumkin qadar ko'p bo'lishi kerak. Shu holdagina topilgan natijalarning *o'rtacha qiymati* haqiqatga yaqin, ishonchli bo'ladi.

Uch turkum hodisa ro'y berishi mumkin: *ishonchli*, ya'ni ro'y berishi muqarrar, *ro'y bermaydigan* va *tasodifiy*. Tanga bir marta tashlanganda uning bir tomoni bilan tushishi turgan gap, ishonchli, bir vaqtda ham raqamli, ham gerbli tomoni bilan tushishi mumkin bo'lmagan, ya'ni ro'y bermaydigan hodisa, qaysi tomoni bilan tushishini esa oldindan aytib bo'lmaydi, tasodifan gerbli tomoni bilan tushishi mumkin. Raqamli tomoni bilan tushishi

ham – tasodifiy. Fizika kursidan ma'lumki, 760 mm sim. ust. atmosfera bosimi va 100 °C temperaturada (bu shart) suv qaynaydi (hodisa). Lekin aslida suvdagi turli aralashmalar ta'sirida ko'rsatilgan shartlarda qaynash nuqtasining o'zgarib turishi kuzatiladi.

Matematikaning tasodifiy hodisalarni o'rganadigan bo'limi *ehtimollik nazariyasi* deb ataladi. Bu nazariya yetarlicha ko'p sonli sinashlar natijasi, ya'ni ommaviy tasodifiy hodisalarning qonuniyatlarini o'rganish bilan shug'ullanadi.

Ehtimollik nazariyasi alohida soha sifatida XVII asr o'rtalarida vujudga kelgan. Uning rivoj topishiga ko'p olimlarning, jumladan, G. Gyuygens, B. Paskal, Ferma, Yakov Bernulli, Muavr, Laplas, Gauss, Puasson, P. G. Chebishev, A. N. Kolmogorovning ishlari alohida o'rin tutadi. Uning taraqqiyotiga o'zbek olimlaridan S. H. Sirojiddinov (1921–1988), T. A. Azlarov ham o'z hissalarini qo'shgan va qo'shib kelmoqdalar.



## Mashqlar

**9.1.** 1) Ishonchli hodisalarga; 2) mumkin bo'lmagan (ro'y bermasligi aniq) hodisalarga; 3) tasodifiy hodisalarga misollar keltiring.

**9.2.** Qaysi biri ehtimollikroq – yoqlari tartib bilan 1 dan 6 gacha raqamlar bilan belgilangan o'yin soqqasini (kubchasini) tashlaganda toq sonning tushishimi yoki juft sonnimi?

**9.3.** Ikkita o'yin kubchasi tashlangan. Nimaning chiqish ehtimolligi kattaroq – ikkalasining ham toq raqamli tarafi bilan tushishimi yoki biri toq, ikkinchisi juft raqam bilan tushishimi?

**9.4.** Sinash: ikki o'yin kubchasini 50 marta tashlang va har qaysi tashlashda chiqadigan ochkolarni (hollar, raqamlarni) yozib boring. Qaysi ochkolar boshqalariga nisbatan ko'proq, kamroq tushgan? Ikkala kubchanning har safar tushgan ochkolari yig'indisi 4, 0, 12 bo'lgan hollaridan qaysi biri ko'proq sodir bo'lgan?

**9.5.** Bukilmagan tanga 20 marta tashlansa-da, faqat gerbli tomoni bilan tushgan. Keyingi tashlashda raqamli tomoni bilan tushishi ehtimolga yaqinmi yoki gerbli tomoni bilan tushishimi?

**2. Boshlang'ich tushunchalar.** Biz geometriya kursida asosiy tushunchalar sifatida nuqta, kesma, tekislik olinishini bilamiz. Ular ta'riflanmay qabul qilinadi. Qolgan tushunchalar shu



boshlang'ich tushunchalar yordamida ta'riflanadi, so'ng xossalari o'rganiladi. Shu kabi ehtimollik nazariyasida elementar hodisa, hodisa va ehtimollik – boshlang'ich tushunchalardir.

Buyum biror shart qo'yilib bir marta tekshirilganda uning yo yaroqli, yoki yaroqsiz chiqishi, boshqa tur hodisaning *ro'y bermasligi* ayon bo'lsin.  $E_1$  – «buyum yaroqli chiqdi»,  $E_2$  – «buyum yaroqsiz chiqdi» belgilashlarini kiritaylik.  $E_1$  va  $E_2$  – nazoratda aniqlangan, umuman, shu kabi tajribada ro'y beradigan ikki *eng sodda*, ya'ni *elementar hodisa*, chunki shu tajriba natijasida ulardan ham soddaroq hodisa ro'y bermaydi, natija  $E_1$  va  $E_2$  *elementar hodisalar to'plamidan* iborat. Elementar hodisani *nuqta*, ularning to'plamini *sinov sxemasi* deb ham ataydilar. Sinov sxemasini to'la-to'kis aniqlay olish juda muhim, aks holda hisoblashlarda xatoliklarga yo'l qo'yilishi mumkin.

Shunday qilib, *hodisa* – elementar hodisalarning biror shart asosida tuzilgan to'plami. Agar bu to'plam bir yoki bir necha (faqat hammasi emas) elementar hodisadan iborat bo'lsa, u *tasodifiy hodisa*, elementar hodisalarning hammasidan iborat bo'lsa, u *muqarrar hodisa* (chunki bu holda elementar hodisalardan kamida bittasi ro'y bergan bo'ladi), birorta ham elementar hodisaga ega bo'lmasa, u ishonchsiz, *mumkin bo'lmagan*, *ro'y bermaydigan hodisa* deyiladi. Tasodifiy hodisalarni  $A, B, C, \dots, X, \dots$ , muqarrar hodisani  $U$ , mumkin bo'lmagan hodisani  $Z$  harfi bilan belgilaymiz.

Tajriba natijasida har bir hodisaning ro'y berish imkoni qolgan hodisalarniki bilan bir xil va bunday hodisalar soni chekli bo'lgan holni *klassik sxema* nomi bilan ataydilar. Bu holda har bir tasodifiy hodisaning ro'y berishini sonli baholash mumkin. Bu son shu tasodifiy hodisaning ro'y berish *ehtimolligi* deyiladi. Uni  $P$  harfi bilan belgilaymiz.

1 - misol. Simmetrik, ya'ni zichligi tekis taqsimlangan kubchanning yoqlari 1 dan 6 gacha raqamlar bilan ketma-ket belgilangan bo'lsin. Kubcha bir marta tashlanganda  $E_1$  – «1» raqami bilan tushdi», ...,  $E_6$  – «6» raqami bilan tushdi», jami  $n = 6$  elementar hodisadan faqat biri tasodifan ro'y beradi.  $n = 6$  – klassik sxema nuqtalari (elementar hodisalar) soni. Nuqtalarning  $U = \{E_1, \dots, E_6\}$  chekli to'plamiga ega bo'lamiz.

**3. Ehtimollikni bevosita hisoblash.** Tajriba «klassik sxema» shartlari bo'yicha o'tkazilayotgan, shu jarayonda ro'y berishi

mumkin bo'lgan barcha elementar hodisalar soni  $n$  ta, shu jumladan biror  $A$  hodisa  $m$  marta ro'y beradigan bo'lsin. U holda  $A$  hodisaning ro'y berish ehtimolligi ushbu nisbatga teng bo'ladi:

$$P(A) = \frac{m}{n}, \quad (1)$$

bunda  $0 \leq m \leq n$ .

1 - misol. Kub bir marta tashlanca, u tasodifan faqat bir yog'i bilan tushadi, ikki yog'i bilan emas, ya'ni  $E_k$ ,  $k = \overline{1; 6}$  elementar hodisalar juft-jufti bilan birgalikda ro'y bermaydi:  $E_i \cap E_j = \emptyset$ ,  $i, j = \overline{1; 6}$ ,  $i \neq j$ . Demak,  $U = E_1 \cup E_2 \cup E_3 \cup E_4 \cup E_5 \cup E_6$ , ya'ni  $U$  to'plam yo  $E_1$ , yo  $E_2$ , ..., yo  $E_6$  ro'y berishi mumkin bo'lgan jami  $n=6$  ta teng imkoniyatli elementar hodisalar to'plamidan iborat. Har qaysi elementar hodisaning ro'y berish ehtimolligi bir xil:

$$P(E_1) = P(E_2) = \dots = P(E_6) = \frac{1}{6}.$$

2 - misol. O'yin kubi bir marta tashlanganda juft yoki toq raqam bilan tushish hodisalari qaraladigan bo'lsa,  $B$  - «juft raqamli tomoni bilan tushdi»,  $C$  - «toq raqamli tomoni bilan tushdi» hodisalari qaraladi. Ular kubning olti yog'ini to'liq o'z ichiga oladi. Demak,  $n = 2$  ta elementar hodisa ro'y beradi. Ularning ro'y berish imkoniyati bir xil, chunki 1, 2, 3, 4, 5, 6 raqamlarining yarmi toq, yarmi juft. Natijalar to'plami  $U = \{B, C\}$ ,  $n = 1, 2$ . Har qaysi hodisaning ro'y berish ehtimolligi bir xil:

$$P(B) = P(C) = \frac{1}{2}.$$

3 - misol. Natijada  $D$  - «tushgan raqamlar 3 dan kichik yoki 3 ga teng»,  $E$  - «tushgan raqamlar 4 ga teng yoki undan katta» hodisalari kubning barcha yoqlarini o'z ichiga oladi. Demak,  $D$  va  $E$  ham elementar hodisalar, birgalikda  $U$  chekli to'plamni tashkil etadi:  $U = \{D, E\}$ ,  $P(D) = P(E) = \frac{1}{2}$ .

4 - misol.  $\{E_5, E_6\}$  to'plam (1-misol) 6 marta o'tkazilgan sinashlar ketma-ketligi uchun barcha natijalar to'plami bo'la olmaydi, chunki bu to'plamga sinashda ro'y berishi mumkin bo'lgan  $E_1, E_2, E_3, E_4$  natijalar tegishli emas.

Ko'p marta takrorlangan sinashlarda har qaysi natija biror son marta takror ro'y bera boshlashi kuzatiladi. Bu holat har qaysi natija ehtimolligini sonli ifodalash uchun «o'lchov birligi» kiritishga imkon beradi. Shu maqsadda qaralayotgan sinashda ro'y



beradigan barcha natijalarning ro'yi berish ehtimolliklari *yig'indisi* 1 ga teng, deb olinadi, u holda har qaysi  $X_k$  natijaga uning ro'yi berish ehtimolligini ifodalovchi biror nomanfiy  $P(X_k) = p_k$  ( $0 \leq p_k \leq 1$ ,  $k = 1, n$ ) son mos keladi. Shart bo'yicha:  $p_1 + p_2 + \dots + p_n = 1$ .

Ko'rsatilgan shartlarda *birgalikda ro'yi bermaydigan*  $n$  ta  $X_1, \dots, X_n$  natijalardan (elementar hodisalardan) har biri bir xil  $p = \frac{1}{n}$  ga teng ehtimollikka ega bo'lsin. Agar jami  $M$  marta o'tkazilgan sinashda  $X_k$  natija  $m_k$  marta ro'yi bergan bo'lsa, uning  $p_k$  ehtimolligi qiymati uchun  $X_k$  elementar hodisa ro'yi bergan hollarning *nisbiy takrorligi (chastotasi)*, ya'ni  $p = \frac{m_k}{M}$  qabul qilinadi. Ehtimollikni bunday hisoblash tartibi ehtimollik tushunchasiga *statistik yondoshish* bo'ladi. Masalan, nishonga otilgan  $M = 200$  ta o'qdan  $m = 150$  tasi nishonga tekkan bo'lsa, o'qning nishonga tegish ehtimolligi  $p = \frac{150}{200} = 0,75$  ga teng bo'ladi.

5 - m i s o l. Ikkita tanga tashlansa, ushbu natijalardan biri ro'yi berishi mumkin:  $A_{2,0}$  – «Ikkala tanga gerb tomoni bilan tushdi»,  $A_{1,1}$  – «Tangalardan biri gerbli tomoni, ikkinchisi raqamli tomoni bilan tushdi»,  $A_{0,2}$  – «Ikkala tanga raqamli tomoni bilan tushdi». GG – «Gerb–gerb tushdi», GR – «Gerb–raqam tushdi», RG – «Raqam–gerb tushdi», RR – «Raqam–raqam tushdi» natijalarni ham qaraylik. Misol shartlarida GG, GR, RG, RR natijalar bir xil  $\frac{1}{4}$  ga teng ehtimollikka ega.  $A_{2,0}$  natija GG bilan,  $A_{0,2}$  natija RR bilan bir xil, lekin  $A_{1,1}$  natijaga GR va RG natijalar mos. Ularning ro'yi berish ehtimolliklari  $P(A_{2,0}) = P(A_{0,2}) = \frac{1}{4}$ ,  $P(A_{1,1}) = \frac{1}{2}$ , ularning *yig'indisi*  $\frac{1}{4} + \frac{1}{4} + \frac{1}{2} = 1$ . Demak, bu hodisalar chekli to'plamni tashkil etadi.



## Mashqlar

**9.6.** Quyida keltirilgan sinashlarda qanday elementar hodisalar ro'yi berishini ayting va natijalar to'plamlarini tuzing:

1) nishon 10 ta ichma-ich joylashgan doiradan iborat bo'lib, ular 1, 2, 3, ..., 10 sonlari bilan raqamlangan. Nishonga qarata o'q uzildi;

2) ikki jamoa o'rtasida voleybol o'yini o'tkaziladi;

3) domino donalaridan bittasi tavakkaliga olindi;

4) tanga 10 marta tashlanadi.

**9.7.** 20 ta bir xil sharcha 1,2, ..., 20 sonlari bilan raqamlanib, xaltaga solingan. Tavakkaliga bitta sharcha olinadi. Quyidagi yozuvlardan qaysi biri natijalar to'plamini ifodalaydi va nima uchun?

1) juft son chiqdi, toq son chiqdi;

2) juft son chiqdi, 8 ga bo'linuvchi son chiqdi;

3) toq son chiqdi, 8 ga bo'linadigan son chiqdi;

4) olingan son 8 dan katta emas, olingan son 9 dan kichik emas.

**9.8.** Tangani 10 marta tashlashdan iborat sinashda ro'y berishi mumkin bo'ladigan barcha natijalar to'plamini quyidagilar bo'yicha tuzing: 1) har bir tashlash natijasi; 2) gerb tomoni bilan tushishlar soni; 3) tanga qaysi tomoni bilan ko'proq tushgani.

**9.9.** Quyidagi misollarning qaysi birida ro'y berishi mumkin bo'lgan natijalar to'liq ko'rsatilgan? 1) molni sotishdan foyda, zarar; 2) basketbol o'yinida yutish, yutqazish; 3) tanga uch marta tashlanganda GGG, GGR, GRR, RRG, RRR, RGR ning tushishi (bunda G – gerb tomoni bilan tushish, R – raqamli tomoni bilan tushishi).

**9.10.** Qutida 4 ta oq va 6 ta qora shar bor. Undan tavakkaliga 2 shar olinadi. «Olingan sharlarning ikkalasi ham oq», «olingan sharlarning ikkalasi ham qora» hodisalari natijalar to'la to'plamini tashkil qiladimi? Agar shunday bo'lmasa, bu ikki hodisaga yana qanday hodisa qo'shilsa, natijalarning to'liq to'plami hosil bo'ladi?

**9.11.** Nishonga qarata to'rt marta o'q otilgan. Quyidagi hodisalar natijalar to'plamini tashkil etadimi: «o'qlardan birortasi ham tegmadi», «bitta o'q tegdi», «birorta ham o'q xato otilmadi», «kamida bitta o'q tegdi»?

**9.12.** Uch natijali sinashga misol keltiring.

**9.13.** Quyidagi tasodifiy hodisalar qancha nuqtaga (elementar hodisaga) egaligini ayting: 1) tavakkaliga olingan ikkita bir xonali sonning yig'indisi 10 ga teng; 2) ularning ko'paytmasi 64 ga teng.

**9.14.** Shunday sinashga misol keltiringki, unda uch elementar hodisadan biri sinash natijasida albatta ro'y beradigan bo'lsin.

**9.15.** Bukilgan tanganing raqamli tomoni bilan tushish ehtimolligi gerbli tomoni bilan tushish ehtimolligidan 5 marta katta. Bu ehtimollik nimaga teng?

9.16. Yashikda 7 ta oq va 15 ta qora shar bor. Tavakkaliga olingan bitta sharning qora shar bo'lish ehtimolligini toping.

9.17. Quyidagi jadval elementar hodisalar chekli to'plamini beradimi?

Natija	$x_1$	$x_2$	$x_3$	$x_4$
Ehtimollik	0,24	0,39	0,26	0,21

9.18. Natijalar to'plami quyidagi jadval bilan berilgan:

Natija	$x_1$	$x_2$	$x_3$	$x_4$	$x_5$
Ehtimollik	0,15	0,3	0,15	0,22	0,18

$x_2$  natija  $x_1$  natijaga nisbatan necha marta ehtimolliroq?

**4. Hodisalar algebra.** Agar elementar hodisalar ehtimolliklari ma'lum bo'lsa, ro'y berishi mumkin bo'lgan turli natijalar, ularning birlashmasi va ko'paytmasi ehtimolligini topish mumkin.

$X$  va  $Y$  hodisalarning *birlashmasi* (*yig'indisi*) deb, shu hodisalarning kamida bittasiga qulaylik tug'diruvchi barcha natijalardan iborat hodisaga aytiladi, uni  $X \cup Y$  orqali belgilaymiz.

$X$  va  $Y$  hodisalar *kesishmasi* (*ko'paytmasi*) deb shu hodisalarning ikkalasiga ham bir vaqtda qulaylik tug'diruvchi barcha natijalardan iborat hodisaga aytiladi, uni  $X \cap Y$  orqali belgilaymiz.

1 - misol.  $A$  – «qizil shar chiqdi»,  $B$  – «oq shar chiqdi» hodisalarining birlashmasi (*yig'indisi*)  $A \cup B$  – «qizil yoki oq shar chiqdi», kesishmasi (*ko'paytmasi*)  $A \cap B$  – «ham oq shar, ham qizil shar chiqdi» hodisalari bo'ladi. Shu kabi  $A = \{a, b, c, d\}$  va  $B = \{b, d, f\}$  uchun  $A \cup B = \{a, b, c, d, f\}$  va  $A \cap B = \{b, d\}$  bo'ladi.

$X$  va  $Y$  hodisalar *ayirmasi* deb,  $X$  hodisaga qulaylik tug'diruvchi, lekin  $Y$  hodisaga qulaylik tug'dirmaydigan barcha natijalardan iborat hodisaga aytiladi va u  $C = X \setminus Y$  orqali belgilanadi.

Agar  $X$  va  $Y$  hodisalar birgalikda ro'y bermasa,  $X \cap Y = \emptyset$  bo'ladi. Agar  $n$  ta hodisadan iborat  $\{X_1, \dots, X_n\}$  to'plamda ixtiyoriy ikki hodisa birgalikda ro'y bermasa, bu hodisalar juft-jufti bilan birgalikda bo'lmaydigan (*kesishmaydigan*), *bog'liqmas* deyiladi. Masalan, «komanda yutdi», «komanda yutqazdi», «komanda durang qildi» hodisalari juft-jufti bilan birgalikda ro'y bermaydi.

Juft-jufti bilan birgalikda bo'lmaydigan  $X_1, X_2, \dots, X_n$  hodisalar birlashmasi natijalarning  $U$  to'liq to'plamini tashkil etsin. Bu

holda  $U$  to'plamni  $X_1, \dots, X_n$  hodisalarning juft-jufti bilan kesishmaydigan qism to'plamlariga ajratish mumkin.

$X$  hodisa ro'y bermaganidagina ro'y beradigan hodisa  $X$  ga *qarama-qarshi* hodisa deyiladi va  $\bar{X}$  (« $X$  emas») orqali belgilanadi. Masalan,  $X$  – «juft sonli ochko tushdi» va  $\bar{X}$  – «toq sonli ochko tushdi» hodisalari qarama-qarshi hodisalaridir.

Agar  $X$  hodisa uchun qulaylik tug'diruvchi har qanday natija  $Y$  hodisa uchun ham qulaylik tug'dirsa,  $Y$  hodisa  $X$  hodisaning *natijasi* deyiladi. Masalan, uchta kubcha tashlanganda «juft ochkolar chiqdi» hodisasi 2, 4, 6 raqamli tomonlari bilan tushganligining natijasidir.



## Mashqlar

**9.19.** Quyidagi tengliklar  $A$  va  $B$  hodisalarga nisbatan qanday shartlar qo'yilsa to'g'ri bo'ladi?

- 1)  $B = (A \cup B) \setminus A$ ;                      2)  $A \cup (C \setminus B) = (A \cup C) \setminus B$ ;  
 3)  $B \setminus A = B$ ;                              4)  $A \setminus B = \emptyset$ ;                      5)  $A \setminus B = B$ .

Javoblarni rasmlarda tushuntiring.

**9.20.** Agar  $A \cup B = C$  bo'lsa,  $B = C \setminus A$  bo'ladi. Shu ta'kid to'g'rimi?

**9.21.** Isbotlang: agar  $B \subset A$  bo'lsa,  $B = A \setminus (A \setminus B)$  bo'ladi.

**9.22.** Yozuvlarning ma'nosini tushuntiring:

- 1)  $\bigcup_{i=3}^8 A_i$ ;      2)  $\bigcap_{j=2}^8 A_j$ ;      3)  $\bigcup_{k=1}^4 A_{3k+1}$ ;      4)  $\bigcap_{k=1}^6 A_{2k-1}$ .

**9.23.** Hodisalar ifodasini qisqaroq yozing:

- 1)  $A_1 \cup A_2 \cup \dots \cup A_{60}$ ;                      2)  $A_1 \cap A_2 \cap \dots \cap A_{50}$ ;  
 3)  $A_4 \cup A_7 \cup \dots \cup A_{55}$ ;                      4)  $A_1 \cap A_3 \cap \dots \cap A_{107}$ .

**9.24.** Ikkita o'yin kubi tashlanib, quyidagi hodisalar qaralgan:  $A$  – «birinchi kub juft raqamli tomoni bilan tushdi»,  $B$  – «birinchi kub toq raqamli tomoni bilan tushdi»,  $C$  – «ikkinchi kub juft raqamli tomoni bilan tushdi»,  $D$  – «ikkinchi kub toq raqamli tomoni bilan tushdi»,  $M$  – «hech bo'lmasa bittasi juft raqamli tomoni bilan tushdi»,  $F$  – «hech bo'lmasa bittasi toq raqamli tomoni bilan tushdi»,  $G$  – «bittasi juft va bittasi toq raqamli

tomoni bilan tushdi»,  $N$  – «birortasi ham juft raqamli tomoni bilan tushmadi»,  $K$  – «ikkalasi ham juft raqamli tomoni bilan tushdi». Bu hodisalar ushbu hodisalarning qaysi biriga teng?

- 1)  $A \cup C$ ;    2)  $A \cap C$ ;    3)  $M \cap F$ ;    4)  $G \cup M$ ;  
 5)  $G \cap M$ ;    6)  $B \cap D$ ;    7)  $M \cup K$ .

**9.25.** Kub uch marta tashlangan.  $A_k$  – « $k$  raqamli tomoni bilan tushdi», bunda  $k = \overline{1; 6}$ , hodisasi bo'lsin.  $A_k$  va  $\bar{A}_k$  hodisalar ustida  $\cup$  va  $\cap$  belgilardan foydalanib, quyidagi amallarni yozing:  $A$  – «uch marta «2» chiqqan»,  $B$  – «uch marta ham «2» chiqmagan»,  $C$  – «hech bo'lmasa «2» chiqqan»,  $D$  – «hech bo'lmasa «2» bo'lmagan»,  $M$  – «kamida «2» chiqqan»,  $F$  – «ko'pi bilan «2» chiqqan».

**9.26.** Besh turdagi mikrobnig ayni bir xil eritmada halok bo'lish-bo'lmasligi kuzatilgan. Kuzatuvchini quyidagi hodisalar qiziqtirgan:  $A$  – «bir turdagi mikrobn halok bo'ldi»,  $B$  – «hech bo'lmasa bitta turdagi mikrobn halok bo'ldi»,  $C$  – «kamida ikkita turdagi mikrobn halok bo'ldi»,  $D$  – «rosa ikkita turdagi mikrobn halok bo'ldi»,  $M$  – «rosa uchta turdagi mikrobn halok bo'ldi»,  $F$  – «besh turdagi mikrobnig hammasi halok bo'ldi». Quyidagi 1–7-hodisalar nimadan iborat, 8–9-tengliklar to'g'rimi? Javoblarni so'z bilan yozing.

- 1)  $\bar{F}$ ;    2)  $A \cup B$ ;    3)  $A \cap B$ ;    4)  $A \cup C$ ;    5)  $B \cap C$ ;  
 6)  $(D \cup M) \cup F$ ;    7)  $B \cap F$ ;    8)  $B \cap F = C \cap F$ ;    9)  $B \cap C = D$ .

**9.27.** Quyida ko'rsatilgan hodisalar qarama-qarshi hodisalarni toping:

- 1) ikki kub tashlangan,  $A$  – «ikkita «6» tushdi»;  
 2) ichida 2 ta oq, 2 ta qizil va 1 ta ko'k shar bo'lgan qutidan tavakkaliga bir shar olinsa,  $B$  – «oq shar chiqdi»;  
 3) nishonga qaratib uch marta o'q otilsa,  $C$  – «uchalasi ham tegdi»;  $D$  – «hech bo'lmasa bitta o'q tegdi»;  $M$  – «ko'pi bilan ikki o'q tegdi»;  
 4) shaxmat bo'yicha Murodov–Rahimov o'yinida  $F$  – «Murodovning yutishi».

**9.28.** Elektr zanjiri ikki qismdan iborat (IX.1-rasm). 1-qism ikkita bir xil elementdan iborat bo'lib, ulardan hech bo'lmaganda bittasi yaroqli bo'lsa, ishlaydi. 2-qism ham ikkita bir xil elementdan iborat, lekin ularning ikkalasi ham yaroqli bo'lsa, ishlaydi. Zanjirdan tok o'tishi uchun ikkala qism ishlab turishi kerak.  $A_k$  –

«1-qismning  $k$ - elementi yaroqli» ( $k = \overline{1; 2}$ ).  $B_n$  – «2-qismning  $n$ - elementi yaroqli»,  $n = (\overline{1; 2})$ . Quyidagi hodisalarni  $\overline{A}_k$ ,  $\overline{B}_n$  hodisalar orqali ifodalang:  $K$  – «1-qism ishlayapti»,  $L$  – «2-qism ishlayapti»,  $M$  – «1-qism ishlamayapti»,  $N$  – «2-qism ishlamayapti».

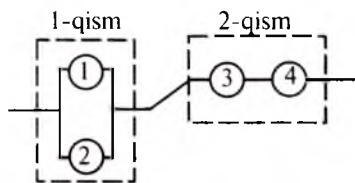

IX.1-rasm.

**9.29.**  $A$  – «tavakkaliga olingan shar – oq shar»,  $B$  – «tavakkaliga olingan shar – qora shar»,  $C$  – «tavakkaliga olingan shar – ko‘k shar» hodisalarini qaraymiz. Quyidagi hodisalar nimadan iboratligini so‘z bilan yozing:

- 1)  $A \cup B$ ;    2)  $\overline{A \cup B}$ ;    3)  $A \cup C$ ;    4)  $A \cup B \cup C$ .

**9.30.** Ikki mergan nishonga qarata o‘q uzmoqda.  $A$  – «birinchi mergan nishonga tekkizdi»,  $B$  – «ikkinchi mergan nishonga tekkizdi» hodisasi bo‘lsa, quyidagi hodisalar nimadan iborat ekanligini so‘z bilan yozing:

- 1)  $A \cup B$ ;    2)  $\overline{A \cup B}$ ;    3)  $A \cap C$ ;    4)  $\overline{A \cap B}$ .

### 5. Hodisalar yig‘indisining ehtimolligi.

1-misol. 50 ta sharcha 1 dan 50 gacha raqamlanib, xaltachaga solingan. Tavakkaliga olingan sharcha nomerining 3 ga yoki 19 ga karrali bo‘lish ehtimolligini topamiz.

Yechish.  $A$  – «olingan sharchaning nomeri 3 ga karrali»,  $B$  – «olingan sharchaning nomeri 19 ga karrali» hodisalari bo‘lsin. Biz  $A \cup B$  hodisaning ro‘y berish ehtimolini topishimiz kerak. 50 gacha bo‘lgan sonlar orasida 3 ga bo‘linuvchilar 16 ta, 19 ga bo‘linuvchilar 2 ta.  $A$  va  $B$  hodisalar birgalikda ro‘y bermaydi, ya‘ni  $A \cap B = \emptyset$ . Shunday qilib, jami 50 ta sondan  $16 + 2 = 18$  tasi

yo 3 ga, yoki 19 ga bo‘linadi. Demak,  $P(A \cup B) = \frac{18}{50} = \frac{9}{25}$ .  $A$  va  $B$

hodisalarning ro‘y berish ehtimolliklari esa  $P(A) = \frac{16}{50} = \frac{8}{25}$ ,

$P(B) = \frac{2}{50} = \frac{1}{25}$ . Xulosa: agar  $A \cap B = \emptyset$  bo‘lsa,  $P(A \cup B) = P(A) + P(B)$  bo‘ladi. Umuman, quyidagi teorema o‘rinli.

**1-teorema.** Birgalikda ro‘y bermaydigan  $A$  va  $B$  hodisalar  $A \cup B$  yig‘indisining ehtimolligi shu hodisalar ehtimolliklarining yig‘indisiga teng:



$$P(A \cup B) = P(A) + P(B), \text{ bunda } A \cap B = \emptyset. \quad (1)$$

**Isbot.** Sinash jarayonida  $A$  hodisa uchun  $a_1, \dots, a_m$  natijalar,  $B$  uchun  $b_1, \dots, b_n$  natijalar qulaylik tug'dirsiz.  $A$  va  $B$  birgalikda ro'y bermaganligidan bu natijalarning hammasi  $A \cup B$  hodisa uchun qulaylik tug'diradi va ular orasida takrorlanadiganlari yo'q. Bu natijalarning ehtimolliklarini mos tartibda  $p_1, \dots, p_m$  va  $q_1, \dots, q_n$  orqali belgilaylik.  $A \cup B$  hodisaning ehtimolligi  $m + n$  ta natijaning ehtimolliklari yig'indisiga teng, ya'ni  $P(A \cup B) = p_1 + \dots + p_m + q_1 + \dots + q_n$  bo'ladi. Lekin  $p_1 + \dots + p_m = P(A)$ ,  $q_1 + \dots + q_n = P(B)$ . Demak,

$$P(A \cup B) = P(A) + P(B).$$

**2 - misol.** Mergan nishonga qarata o'q uzdi. Uning «10» likni urish ehtimolligi 0,2 ga, «9» likni urish ehtimolligi 0,3 ga va «8» likni urish ehtimolligi 0,4 ga teng. Kamida «8» likni urish ehtimolligi nimaga teng?

**Yechish.**  $A$  – «kamida «8» likni urish» hodisasi,  $B$  – «o'nlikni urish»,  $C$  – «to'qqizlikni urish»,  $D$  – «sakkizlikni urish» hodisalarining birlashmasidan iborat. Bir otishda ham «8» ni, ham «9» ni, ham «10» ni urish mumkin emas. Shunga ko'ra  $B, C, D$  hodisalar bir vaqtda ro'y bermaydi:  $A = B \cup C \cup D$ ,  $B \cap C = \emptyset$ ,  $B \cap D \neq \emptyset$ ,  $C \cap D = \emptyset$ . 1-teoremaga asosan va  $B \cup C \cup D = (B \cup C) \cup D$  ligidan

$$P(A) = P((B \cup C) \cup D) = P(B \cup C) + P(D) = P(B) + P(C) + P(D) = 0,2 + 0,3 + 0,4 = 0,9$$

ga ega bo'lamiz. Bu misoldan ushbu xulosaga kelamiz:

**Xulosa.** Agar  $A_1, \dots, A_n$  hodisalar juft-jufti bilan birgalikda ro'y bermasa, shu hodisalar birlashmasining ehtimolligi ularning ehtimolliklari yig'indisiga teng:

$$P(A_1 \cup \dots \cup A_n) = P(A_1) + \dots + P(A_n). \quad (2)$$

**2 - teorema.** Har qanday  $A$  hodisa uchun ushbu tenglik o'rinni:

$$P(\bar{A}) = 1 - P(A). \quad (3)$$

**Isbot.**  $A \cap \bar{A} = \emptyset$ ,  $A \cup \bar{A} = U$  va  $P(U) = 1$  bo'lgani uchun 1-teoremaga asosan  $P(U) = P(A \cup \bar{A}) = P(A) + P(\bar{A}) = 1$ . Bundan (3) formula kelib chiqadi.

**3 - misol.** Ulanadigan telefon nomerlarining oxirgisi 3 ga karrali yoki juft raqam bo'lish ehtimolligini topamiz.

Yechish. Umuman oxirgi raqam yo 0, yoki 1, ..., yoki 9 bo'ladi. Ulardan har biri – elementar tasodifiy hodisa, har birining ehtimolligi  $\frac{1}{10}$  ga teng. Ehtimolligi topilayotgan hodisani  $A$ , oxirgi nomerining  $k$  ( $k = \overline{0; 9}$ ) bo'lish hodisasini  $A_k$  desak,  $A = (A_0, A_2, A_3, A_4, A_6, A_8, A_9)$  va

$$P(A) = P(A_0) + P(A_2) + P(A_3) + P(A_4) + P(A_6) + P(A_8) + P(A_9) = 7 \cdot \frac{1}{10} = \frac{7}{10}$$

bo'ladi.

$R(A)$  ehtimollik bevosita 2-teorema bo'yicha hisoblanishi ham mumkin.  $\bar{A} = (A_1, A_5, A_7)$  bo'lganidan  $P(\bar{A}) = \frac{1}{10} + \frac{1}{10} + \frac{1}{10} = \frac{3}{10}$ .

2- teoremaga asosan  $P(A) = 1 - P(\bar{A}) = 1 - \frac{3}{10} = \frac{7}{10}$ . Misolimizda  $A$  ning ehtimolligini  $\bar{A}$  ning ehtimolligi orqali hisoblash qulayroq bo'lib chiqdi.

**3 - t e o r e m a .** *Ixtiyoriy ikki hodisa uchun ushbu tenglik o'rinli:*

$$P(A \cup B) = P(A) + P(B) - P(A \cap B). \quad (4)$$

**I s b o t \* .**  $A$  hodisa birgalikda bo'lmagan  $A \cap B$  va  $A \cap \bar{B}$  hodisalardan,  $B$  hodisa esa birgalikda bo'lmagan  $A \cap B$  va  $\bar{A} \cap B$  hodisalardan iborat, ya'ni

$$A = (A \cap B) \cup (A \cap \bar{B}); \quad B = (A \cap B) \cup (\bar{A} \cap B).$$

Bundan:

$$\begin{aligned} A \cup B &= (A \cap B) \cup (A \cap \bar{B}) \cup (A \cap B) \cup (\bar{A} \cap B) = \\ &= (A \cap B) \cup (A \cap \bar{B}) \cup (\bar{A} \cap B). \end{aligned}$$

Bu yoyilmadagi hodisalar juft-jufti kesishmaganligidan:

$$P(A \cup B) = P(A \cap B) + P(A \cap \bar{B}) + P(\bar{A} \cap B). \quad (5)$$

Ikkinchi tomondan,

$$P(A) = P(A \cap B) + P(A \cap \bar{B}) \quad \text{va} \quad P(B) = P(A \cap B) + P(\bar{A} \cap B).$$

Shunga ko'ra:  $P(A) + P(B) = 2P(A \cap B) + P(A \cap \bar{B}) + P(\bar{A} \cap B)$  yoki (5) tenglikka asosan,  $P(A) + P(B) = 2P(A \cap B) + P(A \cap \bar{B}) + P(\bar{A} \cap B) - P(A \cap B)$  bo'ladi, bundan (4) kelib chiqadi.

3-teoremani uch va undan ortiq hodisa uchun umumlashtirish mumkin:



$$P(A \cup B \cup C) = P(A) + P(B) + P(C) - P(A \cap B) - P(A \cap C) - P(B \cap C) + P(A \cap B \cap C) \quad (6)$$

va hokazo.



## Mashqlar

**9.31.** Taroziida tortilayotgan lavlagining 3 kg chiqish ehtimolligi 0,46 ga, 4 kg chiqish ehtimolligi 0,31 ga, 5 kg chiqish ehtimolligi esa 0,23 ga teng. Tavakkaliga olingan lavlagining 3 yoki 4 kg chiqish ehtimolligini toping.

**9.32.** Ixtiyoriy to'rtta  $A, B, C, D$  hodisa uchun  $P(A \cup B \cup C \cup D)$  formulasini keltirib chiqaring.

**9.33.** 1- buyumning sotilish ehtimolligi 0,5 ga, 2- buyumniki 0,3 ga, 3- buyumniki 0,2 ga teng. 1) Kamida bir buyumning sotilish ehtimolligi nimaga teng? 2) 2- yoki 3- buyumni sotish ehtimolligi-chi?

**9.34.** Uch buyumdan birinchisiga talab bo'lish ehtimolligi 0,19 ga, ikkinchisiga 0,17 ga, uchinchisiga esa 0,2 ga teng. Kamida bir buyumga talab bo'lish ehtimolligini toping.

**9.35.**  $P(A)$  va  $P(\bar{A} \cap B)$  ehtimolliklar ma'lum.  $P(A \cap B)$  ni toping.

## 2-§. Bog'liqmas hodisalar

**1. Bog'liqmas tasodifiy hodisalar.** Sinashlar ushbu shartlar bilan takror o'tkazilayotgan bo'lsin:

1) bir sinash natijasi ikkinchisiga bog'liq emas (erkli), ya'ni sinashda biror  $A$  hodisaning ro'y berish-bermasligi uning boshqa sinashlarda ro'y bergan-bermaganligiga bog'liq emas;

2) har qaysi sinash ikki natijaga ega:  $A$  hodisa yo ro'y beradi, yoki ro'y bermaydi;

3) agar sinashda  $A$  hodisaning ro'y berish ehtimolligi o'zgarmas  $p$  songa teng bo'lsa, ro'y bermaslik ehtimolligi  $q = 1 - p$  bo'ladi.

Oldingi misollarda takroriy erkli sinashlar qaralgan edi. Jumladan, nishonga bir necha marta o'q otish (bunda ikki natijadan biri o'rinli bo'ladi – o'q nishonga tegadi yoki tegmaydi); detallarni yaroqli yoki yaroqsizligi bo'yicha takror nazoratdan o'tkazish; tanganing ko'p marta tashlanishi (har tashlashda gerb tomoni bilan tushishi yoki tushmasligi).

Agar birinchi sinash  $m$  ta teng ehtimolli natijalarga, ikkinchi sinash  $n$  ta shunday natijalarga ega bo'lsa, bunday natijalardan jami  $mn$  ta juftlik tuzish mumkin. Jumladan,  $A$  hodisaga birinchi sinashning  $k$  ta  $a_1, \dots, a_k$  natijalari,  $B$  ga ikkinchi sinashning  $l$  ta  $b_1, b_2, \dots, b_l$  natijalari qulaylik tug'dirsin. U holda  $A \cap B$  hodisaga barcha  $(a_i, b_j)$ ,  $i = \overline{1; k}$ ,  $j = \overline{1; l}$  juftliklar qulaylik tug'diradi. Ular  $kl$  ta. Shunga ko'ra  $A \cap B$  hodisaning ehtimolligi  $P(A \cap B) = \frac{kl}{mn}$  ga teng. Lekin  $P(A) = \frac{k}{m}$ ,  $P(B) = \frac{l}{n}$  va  $\frac{kl}{mn} = \frac{k}{m} \cdot \frac{l}{n}$  demak,  $P(A \cap B) = P(A) \cdot P(B)$ , ya'ni ikki  $A$  va  $B$  erkli tasodifiy hodisaning birgalikda ro'y berish ehtimolligi ularning har birining ro'y berish ehtimolliklarining ko'paytmasiga teng:

$$P(A \cap B) = P(A) \cdot P(B). \quad (1)$$

Agar  $A$  va  $B$  hodisalar bog'liqmas bo'lsa,  $A$  bilan  $\overline{B}$ ,  $\overline{A}$  bilan  $B$ ,  $\overline{A}$  bilan  $\overline{B}$  hodisalar ham bog'liqmas bo'ladi va ushbu tenglikka ega bo'lamiz:

$$P(A \cup B) = P(A) + P(B) - P(A) \cdot P(B). \quad (2)$$

1 - misol. Kub tashlanganda  $A$  - «juft son tushdi» va  $B$  - «tushgan son 3 ga bo'linadi» hodisalari bog'liqmas ekanini isbot qilamiz.

Yechish. Juft sonli ochkolar uchta (2, 4, 6). Demak,  $P(A) = \frac{3}{6} = \frac{1}{2}$ . Barcha ochkolar ichida 3 ga bo'linuvchilar ikkita (3 va 6). Demak,  $P(B) = \frac{2}{6} = \frac{1}{3}$ . Juft va 3 ga bo'linuvchi son bitta, bu 6 soni. Demak,  $P(A \cap B) = \frac{1}{6}$ . Natijalarga qaraganda  $P(A \cap B) = \frac{1}{6} = \frac{1}{2} \cdot \frac{1}{3} = P(A) \cdot P(B)$  tenglik bajarilmoqda. Demak,  $A$  va  $B$  - bog'liqmas hodisalar.

2 - misol. Birinchi brigadaning rejani bajarish ehtimolligi 0,9 ga, ikkinchisniki 0,92 ga teng. Birining rejani bajarishi ikkinchisnikiga bog'liq emas. Ulardan hech bo'lmasa birining rejani bajarish ehtimolligini topamiz.

Yechish.  $A$  - «1-brigada rejani bajardi»,  $B$  - «2-brigada rejani bajardi» hodisalari bo'lsin. Rejalarni bajarishda ular o'rtasida bog'liqlik yo'q. Shunga ko'ra:

$$P(A \cup B) = P(A) + P(B) - P(A) \cdot P(B) = 0,9 + 0,92 - 0,9 \cdot 0,92 = 0,992.$$

Agar  $A, B, C, \dots$  hodisalar ixtiyoriy qism-to'plami uchun uni tashkil qiluvchi hodisalar kesishmasining ehtimolligi ularning ehtimolliklari ko'paytmasiga teng bo'lsa, bu hodisalar *to'plam bo'yicha bog'liq emas (erkli)* deyiladi.

3-misol. Uch ovchi bir vaqtda va bir-birlaridan mustaqil ravishda bir quyonga qaratib faqat bittadan o'q uzishgan. Agar ovchilardan aqalli bittasi quyonga o'q tekkizgan bo'lsa, quyon otilgan bo'ladi. Har qaysi ovchining nishonga o'q tekkizish ehtimolligi 0,4 ga teng. Quyoning otilish ehtimolligini topamiz.

**Yechish.** Haqiqatda uchta erkli sinash o'tkazilmoqda. Har qaysi sinash ikki natijali: quyonga o'q tegdi, o'q tegmadi.  $A_k$  — « $k$ -ovchi tekkizdi»,  $\bar{A}_k$  — « $k$ -ovchi tekkiza olmadi» hodisalari bo'lsin, bunda  $k = \overline{1; 3}$ . Masalaning sharti bo'yicha  $P(A_1) = P(A_2) = P(A_3) = 0,4$ . U holda  $P(\bar{A}_1) = P(\bar{A}_2) = P(\bar{A}_3) = 1 - 0,4 = 0,6$ . Biz  $A_1 \cup A_2 \cup A_3$  — «quyonga yo 1-ovchi, yoki 2-ovchi, yoki 3-ovchi o'q tekkizdi» hodisasining ehtimolligini topishimiz kerak:

$$\begin{aligned} P(A_1 \cup A_2 \cup A_3) &= 1 - P(\overline{A_1 \cup A_2 \cup A_3}) = 1 - P(\bar{A}_1 \cap \bar{A}_2 \cap \bar{A}_3) = \\ &= 1 - P(\bar{A}_1) \cdot P(\bar{A}_2) \cdot P(\bar{A}_3) = 1 - 0,6 \cdot 0,6 \cdot 0,6 = 0,784. \end{aligned}$$

3-misolni yechishda qarama-qarshi hodisalarning ehtimolligidan foydalanildi. Ba'zan bu usul hisoblashlarni nisbatan yengil bajarishga imkon beradi. Umuman,  $A$  hodisasining  $n$  marta takrorlangan erkli sinashlarda aqalli bir marta ro'y berish ehtimolligini,

ya'ni  $P\left(\bigcup_{k=1}^n A_k\right)$  ehtimollikni quyidagicha topish mumkin:

$$\begin{aligned} P\left(\bigcup_{k=1}^n A_k\right) &= 1 - P\left(\overline{\bigcup_{k=1}^n A_k}\right) = 1 - P\left(\bigcap_{k=1}^n \bar{A}_k\right) = \\ &= 1 - P(\bar{A}_1) \cdot P(\bar{A}_2) \cdot \dots \cdot P(\bar{A}_n) = 1 - q^n, \end{aligned}$$

bunda har qaysi  $A_k$ ,  $k = \overline{1; n}$ , hodisa uchun  $P(A_k) = p$ , u holda  $q = 1 - p$ .

Lekin shuni unutmaslik kerakki, hodisalarning juft-jufti bilan bog'liq emasligidan ularning to'plam bo'yicha bog'liq emasligi kelib chiqmaydi.



## Mashqlar

**9.36.** Bir qutida oq va qora sharlar, ikkinchisida ko'k va qizil sharlar bor. Qutilardan tavakkaliga bittadan shar olingan.  $A$  —

«birinchi qutidan oq shar olingan» va  $B$  – «ikkinchi qutidan ko'k shar olingan» hodisalarning o'zaro bog'liq emasligini tushuntiring.

**9.37.** Bir vaqtda tanga va o'yin kubchasi tashlandi. «Tanga gerb tomoni bilan tushdi» va «Kubda «2» ochko chiqdi» hodisalarining o'zaro bog'liq emasligini tushuntiring.

**9.38.** Ikki detal bir-birlaridan mustaqil holatda nazoratdan o'tkazilmoqda. Birinchi detalning yaroqsiz chiqmaslik ehtimolligi 0,7 ga, ikkinchisniki 0,8 ga teng.  $A$  – «detallarning ikkovi ham yaroqsiz chiqmadi»,  $B$  – «ikkovi ham yaroqsiz chiqdi» hodisalarining ehtimolligini toping.

**9.39.**  $A$  va  $B$  hodisalar o'zaro bog'liq emas.  $A$  va  $\bar{B}$  lar ham o'zaro bog'liq emasligini tushuntiring.

**9.40.**  $A$ ,  $B$ ,  $C$  hodisalar o'zaro bog'liq emas. a)  $A$ ,  $\bar{B}$ ,  $\bar{C}$ ; b)  $\bar{A}$ ,  $B$ ,  $\bar{C}$ ; d)  $\bar{A}$ ,  $\bar{B}$ ,  $C$  hodisalarning ham o'zaro bog'liq emasligini tushuntiring.

**9.41.** Bir nishonga qarata uch marta o'q uzilgan. Birinchi o'qning tegish ehtimolligi 0,7 ga, ikkinchi va uchinchiniki 0,6 ga teng.

- 1) Hech bo'lmasa bitta o'q tegishining;
- 2) rosa bitta o'q tegishining;
- 3) rosa ikkita o'q tegishining;
- 4) uchta o'qning ham tegishining ehtimolligini toping.

**9.42.** To'plam bo'yicha birgalikda bo'lmaydigan ikki hodisa o'zaro erkli bo'la oladimi?

**9.43.** Uch marta o'q uzilganda hech bo'lmasa birining nishonga tegish ehtimolligi 0,992 ga teng. Bitta o'q uzilganda uning nishonga tegish ehtimolligini toping.

**2. Shartli ehtimollik.**  $A$  hodisa  $B$  hodisa ro'y bergandagina ro'y bersin.  $A$  hodisaning  $B$  hodisaning ro'y berishi shartida ro'y berishini  $A | B$  orqali belgilaymiz.  $A | B$  hodisa ro'y berishining ehtimolligi *shartli ehtimollik* deyiladi va u ushbu formula bo'yicha hisoblanadi:

$$P(A | B) = \frac{P(A \cup B)}{P(B)}, \quad (P(B) > 0). \quad (1)$$

O'yin kubi tashlangan bo'lsin. Har bir «1», «2», ..., «6» raqamning tushish ehtimolligi  $\frac{1}{6}$  ga teng va  $P(\langle 1 \rangle) + \dots + P(\langle 6 \rangle) = 1$  tenglik o'rinlidir. U holda  $B$  – «juft raqam tushish» hodisasi ehtimolligi  $P(B) = \frac{3}{6} = \frac{1}{2}$  bo'ladi. Faqat juft raqam tushadigan

bo'lsa, u holda toq raqamlarning tushish ehtimolligi nolga aylanadi:  $P(A_1) = P(A_3) = P(A_5) = 0$ . Shunga ko'ra juft raqamlar tushish ehtimolligi biror  $\lambda$  son marta ortadi. Masalan, «2» ochko tushish ehtimolligi oldin  $P(\langle 2 \rangle) = \frac{1}{6}$  edi, endi  $\lambda P(\langle 2 \rangle) = \lambda \cdot \frac{1}{6}$  bo'ladi. Bizda  $R(A_1) + P(A_2) + \dots + P(A_6) = 1$  bo'lganidan  $\lambda R(\langle 2 \rangle) + \lambda R(\langle 4 \rangle) + \lambda P(\langle 6 \rangle) = 1$ , yoki  $\lambda(P(\langle 2 \rangle) + \lambda P(\langle 4 \rangle) + \lambda P(\langle 6 \rangle)) = \lambda P(B) = 1$ , bundan:

$$\lambda = \frac{1}{P(B)}. \quad (2)$$

Endi biror  $A$  hodisaning  $B$  hodisaning ro'y berishi shartida ro'y berish ehtimolligini hisoblash masalasiga o'tamiz.  $A$  hodisaga qulaylik tug'diruvchi natijalardan ba'zilari  $B$  ga ham qulaylik tug'dirishi mumkin va shunga ko'ra ularning ehtimolligi  $\lambda = \frac{1}{P(B)}$  marta ortadi.  $A$  ga qulaylik tug'dirsa-da,  $B$  ga noqulay bo'lgan natijalar ehtimolligi nolga aylanadi. Birinchi tur natijalar  $A \cap B$  hodisani tashkil qiladi. U holda  $P(A | B) = \lambda P(A \cap B)$  ga, ya'ni (1) munosabatga ega bo'lamiz.

1 - misol. 15 yigit va 10 qizdan iborat guruhda sportchilar 8 kishi, shundan 3 tasi qiz bola. Tavakkaliga bir o'quvchi tanlangan.  $B$  — «tanlangan o'quvchi — sportchi»,  $A$  — «qiz bola tanlangan»,  $A \cap B$  — «sport bilan shug'ullanuvchi qiz bola tanlangan» hodisalari uchun  $P(B) = \frac{8}{25}$ ,  $P(A) = \frac{10}{25}$ ,  $P(A \cap B) = \frac{3}{25}$  bo'ladi.  $A$  hodisa ro'y bergan bo'lsin. Bu sinashdagi barcha natijalar soni 8 ta, lekin  $A$  uchun 3 ta natija qulaylik tug'diradi. Demak,  $P(A | B) = \frac{3}{8}$  ( $B$  hodisaning ro'y berish shartida  $A$  hodisaning ro'y berish ehtimolligi). Kasrning surat va maxrajini 25 ga bo'lsak:

$$P(A | B) = \frac{3}{8} = \frac{3/25}{8/25} = \frac{P(A \cap B)}{P(B)}.$$

Lekin, (1) munosabat bo'yicha ushbu ko'paytirish formulasini hosil qilamiz:

$$P(A \cap B) = P(B) \cdot P(A | B). \quad (3)$$

(3) formulani bog'liqmas hodisalar uchun to'g'ri bo'lgan  $P(A \cap B) = P(B) \cdot P(A)$  formula bilan solishtirib, bu holda  $P(A | B) = P(A)$  bo'lishini aniqlaymiz. Shunga ko'ra bog'liq

bo'lmagan hodisalardan birining ro'y berishi ikkinchisining ehtimoligiga ta'sir ko'rsatmaydi.

2 - misol. Quyidagi jadvalda ikki omborga ikki sexdan keltirilgan buyumlar miqdori ko'rsatilgan:

	1-sex	2-sex	Jami
1-ombor	1000	2000	3000
2-ombor	2000	3000	5000
Hammasi	3000	5000	8000

Tavakkaliga omborlardan biri, so'ng shu ombordagi buyumlardan tanlangan. Buyumning a) 1, 2- ombordan olinganligi ( $A_1, A_2$  hodisalar) va bu shartlarda 1- sexda, 2- sexda tayyorlanganligi ( $B_1, B_2$  hodisalar) ehtimolliklarini; b) aynan 1- sexda tayyorlanganlik ehtimolligi  $P(B_1)$  ni topamiz.

Yechish.

$$a) P(A_1) = \frac{3000}{8000} = \frac{3}{8}, P(A_2) = \frac{5000}{8000} = \frac{5}{8},$$

$$P(B_1 | A_1) = \frac{1000}{3000} = \frac{1}{3}, P(B_1 | A_2) = \frac{2000}{5000} = \frac{2}{5}.$$

b) Tavakkaliga 1-omborni tanlash va undan olingan buyumning 1-sexda tayyorlangan bo'lishi  $A_1 \cap B_1$  hodisa, 2-omborni tanlash va undan olingan buyumning 1-sexda tayyorlangan bo'lishi esa  $A_2 \cap B_1$  hodisa bo'ladi. U holda «tavakkaliga tanlangan ombordan olingan buyumning 1-sexda tayyorlangan bo'lish» hodisasi  $B_1$  birgalikda bo'lmagan  $A_1 \cap B_1$  va  $A_2 \cap B_1$  hodisalar birlashmasidan iborat bo'ladi va

$$P(B_1) = P(A_1 \cap B_1) + P(A_2 \cap B_1) = P(A_1) \cdot P(B_1 | A_1) + P(A_2) \cdot P(B_1 | A_2). \quad (4)$$

$$\text{Bunga ko'ra } P(B_1) = \frac{3}{8} \cdot \frac{1}{3} + \frac{5}{8} \cdot \frac{2}{5} = \frac{13}{24}.$$

2-misolning tahlilida olingan (4) munosabat *to'la ehtimollik formulasi* deb ataluvchi ushbu umumiy formulaning xususiy ko'rinishidan iborat:

$$P(A) = P(X_1) \cdot P(A | X_1) + \dots + P(X_n) \cdot P(A | X_n), \quad (5)$$

bunda  $U = X_1 \cup \dots \cup X_n$ .  $X_i \cap X_j = \emptyset$ ,  $i \neq j$ .

To'la ehtimollik formulasi ko'rinishlardan biri ushbu *Bayes formulasidir*:

$$P(X_k | A) = \frac{P(X_k) \cdot P(A|X_k)}{P(X_1) \cdot P(A|X_1) + \dots + P(X_n) \cdot P(A|X_n)}. \quad (6)$$

(6) munosabatni isbot qilish uchun

$$P(A \cap X_k) = P(X_k) \cdot P(A | X_k) = P(A) \cdot P(X_k | A)$$

bo'lishini e'tiborga olish yetarli.

3 - misol. Omborga 1- sexdan 2000 ta detal, 2- sexdan 3000 ta detal kelgan. Lekin 1- sex o'rta hisobda 0,2% yaroqsiz, 2- sex esa 0,1% yaroqsiz detal beradi. Tasodifan olingan bir detalning yaroqsiz bo'lish ehtimolligini topamiz.

Yechish.  $A_1$  – «tasodifan 1- sex detali olingan»,  $A_2$  – «tasodifan 2- sex detali olingan»,  $B$  – «yaroqsiz detal olingan» hodisalarining ehtimolliklarini topamiz:

$$P(A_1) = \frac{2000}{5000} = 0,4, \quad P(A_2) = \frac{3000}{5000} = 0,6,$$

$$P(B | A_1) = \frac{0,2}{100} = 0,002, \quad P(B | A_2) = \frac{0,1}{100} = 0,001,$$

(5) formulaga ko'ra

$$\begin{aligned} P(B) &= P(A_1) \cdot P(B | A_1) + P(A_2) \cdot P(B | A_2) = \\ &= 0,4 \cdot 0,002 + 0,6 \cdot 0,001 = 0,0014. \end{aligned}$$

4 - misol. 3-misolda tasodifan olingan buzuvq detal 1- sexda tayyorlangan ( $A_1 | B$  hodisa) va 2- sexda tayyorlangan ( $A_2 | B$  hodisa) bo'lishi ehtimolliklarini topamiz.

Yechish. Bayes formulasidan foydalanamiz:

$$\begin{aligned} P(A_1 | B) &= \frac{P(A_1) \cdot P(B|A_1)}{P(A_1) \cdot P(B|A_1) + P(A_2) \cdot P(B|A_2)} = \frac{P(A_1) \cdot P(B|A_1)}{P(B)} = \\ &= \frac{0,4 \cdot 0,02}{0,0014} \approx 0,57, \end{aligned}$$

$$P(A_2 | B) = \frac{P(A_2) \cdot P(B|A_2)}{P(B)} = \frac{0,6 \cdot 0,001}{0,0014} \approx 0,43.$$



## Mashqlar

**9.44.** 100 ta elektr lampochkasidan 4 tasi nostandart ekani ma'lum. Bir vaqtda tavakkaliga olingan 2 ta lampochkaning nostandart bo'lib chiqish ehtimolligini toping.



**9.45.**  $n = 50$  ta tayoqchani har biri kalta-yu-uzun ikkiga bo'linadi. Hosil bo'ladigan  $2n = 100$  bo'lakdan ikkitasi olinib, yangi tayoqcha tayyorlanadi. Yangi tayoqchani xuddi avvalgining o'zidek bo'lish ehtimolligini toping.

**9.46.** Qutida 10 ta qizil, 6 ta yashil, 14 ta ko'k shar bor. Tavakkaliga ikkita shar olinadi. 1)  $A_1$  – «qizil shar olinmagani ma'lum, olingan ikkala shar ko'k» bo'lishining; 2)  $A_2$  – «ko'k shar olinmagani ma'lum, olingan ikkala shar qizil» bo'lishining; 3)  $A_3$  – «yashil shar olinmagani ma'lum, olingan sharlar har xil rangda» bo'lishining ehtimolligini toping.

**9.47.** Birinchi qutida 30 ta, ikkinchisida 50 ta, uchinchisida 20 ta konfet bor. Birinchi qutidagilarning 80% i, ikkinchi qutidagilarning 70% i, uchunchi qutidagilarning 50% i yumshoq. Tavakkaliga olingan bitta konfetning yumshoq bo'lib chiqish ehtimolligini toping.

**9.48.** Birinchi dastgohda 0,2%, ikkinchisida 0,3%, uchinchisida 0,5% yaroqsiz detal tayyorlanishi ma'lum. Birinchi dastgohdan 4000 ta, ikkinchisidan 8000 ta, uchinchisida 3000 ta detal kelgan va aralashtirilgan. Ulardan tavakkaliga olingan detallarning yaroqsiz bo'lib chiqish ehtimolligini toping.

**9.49.** Nishonga bog'liqsiz ravishda to'rt marta o'q uzilgan. Otuvchining har otishida nishonga tegish ehtimolligi 0,6 ga teng. Oldingi uch otishdan nishonga tekkiza olmaslik va to'rtinchi otishda nishonga tekkizish ehtimolligini toping.

**9.50.** Motor ulanganda  $p$  ehtimollik bilan ishlay boshlaydi: 1) ikkinchi ulashda motor ishlay boshlashining; 2) motorni ishga tushirish uchun ikkitadan ortiq ulashlar talab qilinmasligining ehtimolligini toping.

**9.51.** Hodisaning shartli ehtimolligi hodisa ehtimolligi kabi quyidagi xossaga ega ekanini isbot qiling: ixtiyoriy  $A$  va  $B$  hodisalar uchun  $0 \leq P(A | B) \leq 1$ .

**9.52.** Ko'paytirish teoremasini (1- teoremani) uchta, to'rtta, ...,  $k$  ta hodisa uchun umumlashtiring.

**9.53.** Agar  $P(A | B) = P(A)$  bo'lsa,  $P(A) \cdot P(B | A) = P(A) \cdot P(B)$  bo'lishini tushuntiring.

**9.54.** 1- omborda 1- buyumdan 20 ta, 2- buyumdan 12 ta, 2- omborda 1- buyumdan 30 ta, 2- buyumdan 10 ta bor. Ixtiyoriy tartibda ikki ombordan biri tanlangan va undan tavakkaliga bir buyum olingan. Uning 1- buyum bo'lish ehtimolligini toping.



**9.55.** Birinchi dastgohning yaroqsiz detalni tayyorlash ehtimolligi 0,01 ga, ikkinchisniki 0,02 ga, uchinchisniki 0,03 ga teng. Dastgohlarda ishlangan detallar bir qutiga solinadi. Birinchi dastgohning unumdorligi ikkinchisnikidan 3 marta katta, uchinchisniki ikkinchisnikidan ikki marta kam. Tavakkaliga olingan detalning yaroqsiz bo'lib chiqish ehtimolligini toping.

**3. Bernulli formulasi.**  $A$  hodisaning ehtimolligi  $r$  ga teng bo'lsin. Agar sinash ma'lum shartlar asosida  $n$  marta erkli takrorlangan va ulardan  $m$  martasida  $A$  hodisa ro'y bergan bo'lsa,  $m/n$  nisbat  $A$  hodisaning ro'y berish chastotasi (takrorlanishi) deyiladi. Kuzatishlar shuni ko'rsatadiki, agar sinash ko'p marta takrorlansa chastota  $n$  ga bog'liq bo'lmagan holda  $p$  ga yaqinlashadi. Masalan, o'yin kubi ko'p marta tashlansa, «3» ochkoning tushish ehtimolligi deyarli  $1/6$  ga teng bo'ladi. Umuman, ehtimollik tushunchasi chastotaning barqarorligi qonuniyatlariga asoslanadi. Bu masala oliy matematika kurslarida batafsil o'rganiladi.

1 - misol.  $n = 5$  marta erkli sinash o'tkazilgan va unda  $A$  hodisaning ro'y berish ehtimolligi  $p = 0,6$  bo'lsin. Natija  $\overline{A}\overline{A}\overline{A}\overline{A}\overline{A}$  tartiblangan to'plam ko'rinishda bo'lish ehtimolligini topamiz.

Yechish. O'rin almashtirishda  $A$  hodisa  $m = 2$  marta,  $\overline{A}$  esa  $n - m = 3$  marta takrorlanmoqda. Har qaysi  $A$  harfini 0,6 bilan,  $\overline{A}$  harfini  $1 - 0,6 = 0,4$  bilan almashtiramiz. Izlanayotgan ehtimollik  $p^m q^{n-m} = 0,6^2 \cdot 0,4^3 \approx 0,02$  bo'ladi.

Umuman, ehtimolligi  $p$  ga teng  $A$  hodisaning  $n$  marta o'tkazilgan erkli sinashda  $m$  marta ro'y berish ehtimolligi  $p^m q^{n-m}$  ga teng bo'ladi, bunda  $q = 1 - p$ .

**Teorema.**  $A$  hodisaning ehtimolligi  $p$  ga teng va bu hodisaning  $n$  marta takrorlangan erkli sinashda  $m$  marta ro'y berish ehtimolligi  $P_{m,n}$  bo'lsin. U holda

$$P_{m,n} = C_n^m p^m q^{n-m} \quad (1)$$

Bernulli formulasi o'rinli bo'ladi.

Isbot.  $n$  marta o'tkazilgan erkli sinashlardan  $m$  tasida  $A$  hodisa ro'y bersin. Sinashlarning har bir shunday natijasi  $m$  ta  $A$  harfi va  $n - m$  ta  $\overline{A}$  harfidan tuzilgan takrorli o'rin almashtirishlar bo'ladi. Lekin ularning umumiy soni

$$P_{(m, n-m)} = \frac{(m+n-m)!}{m!(n-m)!} = \frac{n!}{m!(n-m)!} = C_n^m$$

ga, bitta o'rin almashtirishning ehtimolligi esa  $p^m q^{n-m}$  ga teng bo'ladi. Shunga ko'ra va bunday o'rin almashtirishlar juft-jufti bilan birgalikda bo'lmaganligidan izlanayotgan ehtimollik (1) tenglik ko'rinishida bo'ladi.

2 - misol. Tanga  $n = 100$  marta tashlanganda «G» (gerb) tomoni bilan  $m = 8$  marta tushish ehtimolligini topamiz.

Yechish. Bir marta tashlanganda «G» tomoni bilan tushish ehtimolligi  $p = \frac{1}{2}$  ga teng. U holda  $q = 1 - p = \frac{1}{2}$  bo'ladi va (1) formula bo'yicha

$$P_{8; 100} = C_{100}^8 \left(\frac{1}{2}\right)^8 \cdot \left(\frac{1}{2}\right)^8 = \frac{100 \cdot 99 \cdot 98 \cdot 97 \cdot 96 \cdot 95 \cdot 94 \cdot 93}{1 \cdot 2 \cdot 3 \cdot 4 \cdot 5 \cdot 6 \cdot 7 \cdot 8} \cdot \frac{1}{2^{100}} = 25 \cdot 10^{-22}$$



### Mashqlar

9.56. 1) (1) formuladan foydalanib,  $n = 5$ ,  $m = 2$  va  $p = 0,2$  holi uchun  $P_{n,m}$  ehtimollik qiymatini toping.

2) O'yin kubi 20 marta tashlanganda «1» ochkoning 5 martadan ortiq tushmaslik ehtimolligini toping.

9.57. O'yin kubi 12 marta tashlanganda 3 ga karrali ochkolarning (raqamlarning) uch martadan ko'p, lekin 6 martadan kam tushish ehtimolligini toping.

9.58. Sakkiz asbobdan har birining buzilish ehtimolligi 0,7 ga teng:

- 1) rosa uch asbobning buzilish ehtimolligini toping;
- 2) asboblarning hammasining buzilish ehtimolligini toping;
- 3) hech bir asbobning buzilmaslik ehtimolligini toping.

9.59. Sinashda  $A$  hodisaning ro'y berish ehtimolligi 0,2 ga teng. Sinash 6 marta takrorlangan.  $A$  hodisaning ko'pi bilan uch marta ro'y berish ehtimolligini toping.

9.60.  $A$  hodisa 0,2 ehtimollik bilan ro'y beradi. Sinash 10 marta mustaqil ravishda takrorlangan. Shu jarayonda  $A$  hodisaning:

- 1) rosa uch marta;
- 2) ko'pi bilan uch marta;
- 3) uchtadan ko'p marta;
- 4) hech bo'lmasa 1 marta, lekin ko'pi bilan 5 marta ro'y berishining ehtimolliklarini toping.

4. Geometrik ehtimolliklar. Ehtimollik nazariyasida shunday masalalar uchraydiki, ular hatto mazmunan sodda bo'lsa-da,

ularni yechishda yuqorida keltirilgan mulohazalar va formulalardan foydalanish yo noqulay, yoki uning iloji bo'lmaydi. Kvadratga tashlangan nuqtaning unga ichki chizilgan doiraga tasodifan tushish ehtimolligini topish bunga oddiy bir misol. Bunday hollarda ba'zan *ehtimollikning geometrik ta'rifi*, ya'ni hodisa ehtimolligini hisoblashning geometrik usulidan foydalanish mumkin. Geometrik ehtimollik quyidagicha ta'riflanadi: biror kesmaga (yuzaga yoki hajmga ega bo'lgan biror geometrik shakl ichiga) nuqta tasodifan tashlangan. Shu nuqta kesmaning (geometrik shaklning) *biror qismiga tushish ehtimolligi* deb, qism uzunligining (yuzining, hajmining) kesma uzunligiga (shakl yuziga, hajmiga) nisbatiga aytiladi. Agar qism bir necha bo'lakdan iborat bo'lsa, bu bo'laklar uzunliklarining (yuzlarining, hajmlarining) yig'indisi olinadi. Geometrik ehtimollik oldingi bandlarda kiritilgan ehtimollikka o'xshash. Masalan, 1) nuqtaning berilgan geometrik shakl ichiga tushish ehtimolligi 1 ga teng, uning qismi uchun esa bu ehtimollik 1 dan kichik; 2) agar  $X$  va  $Y$  qismlar umumiy nuqtalarga ega bo'lmasa (kesishmasa),  $P(X \cup Y) = P(X) + P(Y)$  bo'ladi. Shuningdek, boshqa tushunchalar, qo'shish va ko'paytirish, to'la ehtimollik va Bayes formulalari geometrik ehtimollik uchun ham o'rinli.

1 - misol. Radiusi  $R$  bo'lgan doira ichiga radiusi  $r$  bo'lgan kichik doira chizilgan. Katta doiraga tasodifan tashlangan nuqtaning kichik doiraga tushish ehtimolligini topamiz.

Yechish.  $A$  — «tasodifan tashlangan nuqta kichik doiraga tushdi» hodisasining ehtimolligi kichik va katta doiralar yuzlari nisbatiga teng:

$$P(A) = \frac{\pi r^2}{\pi R^2} = \left(\frac{r}{R}\right)^2.$$

2 - misol. Nuqta o'lchamlari 3 dm, 4 dm, 5 dm bo'lgan to'g'ri parallelepi ped ichiga tashlangan. Nuqtaning parallelepi ped ichidagi tomonlari 1 dm bo'lgan kub ichiga tasodifan tushish ehtimolligini topamiz.

Yechish.  $A$  — «nuqta kub ichiga tushdi» hodisasi bo'lsin. Sinash natijalariga mos nuqtalar parallelepiped ichida tekis taqsimlangan bo'lsin. U holda  $A$  hodisaning ro'y berish ehtimolligi

kubning o'lchamiga proporsional va  $P(A) = \frac{V_{\text{kub}}}{V_{\text{paral}}}$  bo'ladi. Bizda

$V_{\text{kub}} = 1 \text{ dm}^3$ ,  $V_{\text{paral}} = 3 \cdot 4 \cdot 5 = 60 \text{ dm}^3$ . U holda  $P(A) = \frac{1}{60} \approx 0,017$  bo'ladi.



## M a s h q l a r

**9.61.** Geometrik ehtimollik hodisa ehtimolligining ushbu asosiy xossalriga ega ekanini tushuntiring: 1) har qanday  $A$  hodisa uchun  $0 \leq P(A) \leq 1$  bo'ladi; 2)  $P(U) = 1$ ,  $P(\emptyset) = 0$ ; 3) agar  $A \cap B = \emptyset$  bo'lsa,  $P(A \cup B) = P(A) + P(B)$  bo'ladi.

**9.62.** Minalar to'g'ri chiziq bo'ylab har 10 m da qo'yib chiqilgan. Kengligi 3 m bo'lgan tank shu to'g'ri chiziqqa perpendikular kelmoqda. Uning portlab ketish ehtimolligi qanday?

**9.63.**  $R$  radiusli aylanada  $A$  nuqta belgilangan. Aylanaga tavakkaliga tashlangan  $B$  nuqta uchun  $AB = R/2$  bo'lib qolish ehtimolligini toping.

**9.64.** Doira ichiga teng yonli to'g'ri burchakli uchburchak chizilgan. Doiraga tavakkaliga tashlangan nuqtaning uchburchakka tushish ehtimolligini toping.

**9.65.** 9.64-masalani doira ichiga muntazam uchburchak chizilgan hol uchun yeching.

**9.66.** Radiusi  $R$  ga teng doira ichiga kvadrat chizilgan. Doiraga tavakkaliga tashlangan ikki nuqtaning kvadratga tushish ehtimolligini toping.

**9.67.**  $x$  va  $y$  haqiqiy sonlar  $|x| < 4$ ,  $|y| < 6$  bo'lish sharti bilan tavakkaliga tanlandi. Bu ikkala sonning musbat bo'lish ehtimolligini toping.

**9.68.** Kub ichiga shar chizilgan. Kubga tavakkaliga tashlangan nuqtaning sharga tushish ehtimolligini toping.

**9.69.** Shar ichiga tetraedr chizilgan. Tavakkaliga shar ichiga tashlangan nuqtaning tetraedr ichiga tushish ehtimolligini toping.

## 3-§. Matematik statistika elementlari

**1. Boshlang'ich ma'lumotlar.** Birgina kuzatish (tajriba, sinash) ham tekshirilayotgan obyekt haqida bir qancha ma'lumot berishi mumkin. Lekin u ko'p sonli hodisalarning tabiatini to'laroq ochish va xulosalar chiqarishga yetarli bo'la olmaydi: tajriba bir xil sharoit va shartlarda ko'p marta takror o'tkazilishi kerak. So'ng topilgan

natijalarning *o'rtacha qiymati* hisoblanadi, *o'rtacha qiymatning* haqiqatga qanchalik yaqinligi, ya'ni *aniqligi* qaralayotgan obyektidagi ayrim belgilarning *o'zgaruvchanlik darajasi* va boshqa belgilar bilan aniqlanadi. Endi to'plangan sonli ma'lumotni matematik ishlash zarur bo'ladi. Uning umumiy usullarini matematikaning sohalaridan *matematik statistika* beradi (inglizcha *statistic*, lotincha *status* – holat). Undan fizika, kimyo, biologiya, muhandislik, astronomiya, iqtisodiyot va boshqa sohalarda, xususan, detallarni ishlashda texnologik jarayon rejimini aniqlash, ishlab chiqarishni rejalashtirish, miqdoriy belgilar orasida mavjud bog'lanishlarning ifodalarini (empirik formulalarni) tuzish kabilarda foydalaniladi. Matematik statistika hisoblashlarida ehtimollik nazariyasi keng qo'llaniladi.

**2. Arifmetik o'rtacha qiymat va o'rta kvadratik chetlanish.** Matematik statistika hodisalarni faqat ma'lumotlar orqali izohlaydi. Ma'lumotni *matematik ishlashdan* kuzatilgan asosiy maqsad o'lchanayotgan  $X$  kattalik qabul qilgan  $x_i$  tasodifiy (empirik) qiymatlarning  $\bar{x}$  *arifmetik o'rtacha qiymati* va  $\sigma$  *o'rta kvadratik chetlanishni* (xatolikni), shuningdek, boshqa zarur belgilarni, jumladan, har qaysi  $x_i$  qiymatning *nisbiy takrorlanishini* aniqlashdan iborat. O'rta kvadratik chetlanish tajribada topilgan  $x_i$  qiymatlarning o'rtacha qiymatdan qanchalik yaqin-uzoq, uning atrofida qanchalik zich joylashganligini xarakterlaydi. Masalan,  $\sigma$  qancha kichik bo'lsa,  $x_i$  qiymatlar  $\bar{x}$  o'rtacha qiymat atrofida shunchalik zich joylashgan bo'ladi, bu esa  $x_i$  qiymatlar  $\bar{x}$  izlanayotgan aniq qiymatga yaqin ekanini, o'lchashlar aniqroq bajarilganini ko'rsatadi. Demak,  $\sigma = 0$  da  $x_i = a$  arifmetik o'rtacha qiymat  $X$  ning *aniq qiymati* bo'ladi.

$X$  miqdor  $n$  marta mustaqil ravishda o'lchangan, natijada uning  $x_1$  qiymati  $n_1$  marta,  $x_2$  qiymati  $n_2$  marta, ...,  $x_k$  qiymati  $n_k$  marta, jami  $k$  xil empirik qiymati  $n_1 + n_2 + \dots + n_k = n$ ,  $k \leq n$  marta ro'y bergan bo'lsin, bunda  $n_i$  son  $x_i$  qiymatning *takrorlanish soni*. U holda:

1) arifmetik o'rtacha qiymat:

$$\bar{x} = \frac{n_1 x_1 + n_2 x_2 + \dots + n_k x_k}{n}, \quad (1)$$

2)  $x_i$  qiymatlarning  $\bar{x}$  arifmetik o'rtacha qiymatdan  $\varepsilon_1 = x_1 - \bar{x}$ ,  $\varepsilon_2 = x_2 - \bar{x}$ , ...,  $\varepsilon_k = x_k - \bar{x}$  chetlanishlari, so'ng  $\sigma$  o'rta kvadratik chetlanish taqriban hisoblanadi, bunda agar o'lchashlar bir necha marta takrorlangan, ya'ni  $n$  qiymati kichik bo'lsa,

$$\sigma^2 \approx \frac{n_1 \varepsilon_1^2 + n_2 \varepsilon_2^2 + \dots + n_n \varepsilon_n^2}{n-1}, \quad (2')$$

ko'p sonli takror o'lchashlarda, ya'ni  $n$  ning katta qiymatlarida:

$$\sigma^2 \approx \frac{n_1 \varepsilon_1^2 + n_2 \varepsilon_2^2 + \dots + n_n \varepsilon_n^2}{n(n-1)}. \quad (2'')$$

3)  $x_i$  qiymatning nisbiy takrorlanishi (kasr son yoki % larda):

$$W(x_i) = \frac{n_i}{n}. \quad (3)$$

Tajriba jarayonida biror  $x_i$  qiymat ro'y bergan bo'lmasa, ya'ni  $n_i = 0$  bo'lsa, uning takrorlanishi  $W(x_i) = 0$ , barcha natijalar faqat shu qiymatdan iborat bo'lsa, uning takrorlanishi  $W_i = 1$  bo'ladi, shu jarayonda  $x_i$  dan boshqa qiymatlar ham hosil bo'lgan bo'lsa,  $0 < W(x_i) < 1$  bo'ladi. Umuman,  $0 \leq W(x_i) \leq 1$  ga ega bo'lamiz.

**3. Taqsimot jadvali, gistogramma, poligon.** Ko'pincha tajriba jarayonida turli qiymatga ega sonlar ketma-ketligi hosil bo'ladi. Hisoblashlarni ixcham va tartib bilan bajarish maqsadida qiymatlarni o'sib borish tartibida joylashtiriladi, ya'ni *empirik taqsimot* ko'rinishida yoziladi. Bu  $n$  son katta bo'lganda juda qulay bo'ladi. Shu maqsadda:

1) barcha  $x_i$  qiymatlar o'sib borish tartibida joylashtiriladi. Bu qiymatlar juda ko'p bo'lsa, ular ichidan ixtiyoriy ajratib olinganlari – *variantalar* tartiblanadi. Variantalar  $n$  ta bo'lsin;

2) taqsimot kengligi, ya'ni eng katta va eng kichik qiymatli variantalar  $x_{\max} - x_{\min}$  ayirmasi topiladi, ularning oralig'i teng uzunlikka ega bo'lgan  $N$  ta intervalga ajratiladi va intervallarning  $\lambda$  uzunligi hisoblanadi:

$$\lambda = \frac{x_{\max} - x_{\min}}{N}. \quad (1)$$

Jami variantalar soni  $n$  ta bo'lsa, intervallar soni  $N$  quyidagicha olinishi mumkin:

$n$	$N$
25–40	5–6
40–60	6–7
60–100	7–10
100–200	10–12
200 va undan ortiq	12–20;



3) har bir intervalga nechta ( $n_i$ ) varianta to'g'ri kelishi (ya'ni  $x_i$  hodisaning ro'y berishlar soni) aniqlanadi va  $W_i = \frac{n_i}{n}$  nisbiy takrorlanish hisoblanadi. Barcha ma'lumot jadvalga yozib boriladi. Bu jadval intervallar uzunligi bilan takrorlanishlar orasidagi bog'lanish, ya'ni tasodifiy miqdorning *empirik taqsimotini* ifodalaydi.

4) ayoniylik uchun jadval grafik usulda, jumladan, poligon yoki gistogramma ko'rinishida beriladi.

*Poligon*: absissa (tasodifiy qiymatlar) o'qining ( $x_{\max}$ ;  $x_{\min}$ ) qismi uzunliklari bir xil ( $\lambda$ ) bo'lgan  $N$  ta intervalga ajratiladi, intervallarning o'rtalarida  $n_i$  yoki  $W_i$  ga proporsional ordinatalar o'tkaziladi va uchlari to'g'ri chiziq bilan tutashtiriladi. Siniq chiziq hosil bo'ladi (IX.2-rasm).

*Gistogramma*: absissa o'qida ajratilgan har bir interval ustiga balandliklari  $n_i$ ,  $W_i$  yoki  $\frac{W_i}{\lambda}$  bo'lgan to'g'ri to'rtburchaklar yasaladi. (yunoncha *histos* – mato, *polygonos* – ko'pburchak) (IX.3-rasm).

1 - misol. Uyumdan tavakkaliga ketma-ket 30 qism paxta olinib, ulardagi tolaning  $X$  uzunligi o'lchangan va ushbu  $x_i$ ,  $i = \overline{1; 30}$ , (sm larda) qiymatlar topilgan: 2,11; 2,10; 2,12; 2,13; 2,09; 2,18; 2,10; 2,20; 2,11; 2,26; 2,17; 2,26; 2,10; 2,24; 2,13; 2,12; 2,27; 2,12; 2,16; 2,19; 2,26; 2,25; 2,18; 2,22; 2,24; 2,28; 2,17; 2,21; 2,23; 2,21. Tolaning  $X$  uzunligi o'rtacha qiymatini topamiz va uning aniqligini baholaymiz.

1-misolga qaytaylik. Unda  $x_{\max} = 2,28$ ,  $x_{\min} = 2,09$ ,  $n = 30$ ,  $N = 5$ ,  $\lambda = (2,28 - 2,09) : 5 = 0,038$ ,  $\lambda$  uchun 0,03 ni olamiz.

Interval №	Interval chegaralari	Hodisalar soni, $n_i$	Nisbiy takrorlanish, $W_i = n_i / n$
1	2,09–2,12	9	9/30 = 0,3
2	2,13–2,16	3	0,1
3	2,17–2,20	6	0,2
4	2,21–2,24	6	0,2
5	2,25–2,28	6	0,2
	Jami:	30	1,0

2 - misol. Tayyorlangan ko'p sonli valiklardan ixtiyoriy 200 tasi olinib, diametrlarining belgilangan o'lchamdan  $\epsilon_i$  chetlanishlari tekshirilgan va bu chetlanishlar  $-20$  mk dan  $+30$  mk gacha jami 78 xil qiymatga ega ekanligi aniqlangan. Chetlanishlarning empirik jadvalini tuzamiz, poligon va gistogrammasini yasaymiz (chetlanishlar intervallarga taqsimlangan holda jadvalda keltirilgan).

Yechish: 1)  $\epsilon_i$  chetlanishlar taqsimot jadvali quyidagicha bo'ladi:

Interval	Interval chegaralari	Interval o'rtasi	Takrorlanish	Nisbiy takrorlanish
1	-20 dan -15 gacha	-17,5	7	0,035
2	-15 dan -10 gacha	-12,5	11	0,055
3	-10 dan -5 gacha	-7,5	15	0,075
4	-5 dan 0 gacha	-2,5	24	0,120
5	0 dan 5 gacha	+2,5	49	0,245
6	5 dan 10 gacha	+7,5	41	0,205
7	10 dan 15 gacha	+12,5	26	0,130
8	15 dan 20 gacha	+17,5	17	0,085
9	20 dan 25 gacha	+22,5	7	0,035
10	25 dan 30 gacha	+27,5	3	0,015
Jami:			200	1,000

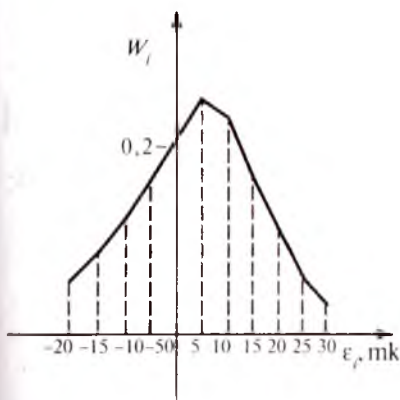

IX.2-rasm. 200 valikning tashqi diametrlari bo'yicha taqsimot poligoni.

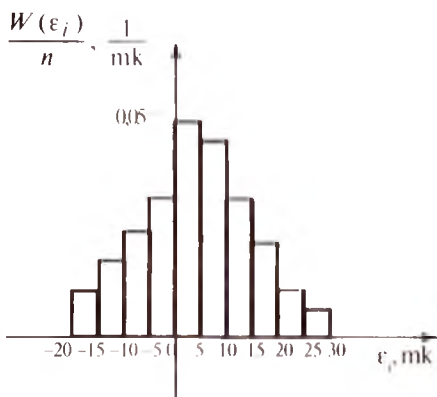

IX.3-rasm. 200 valikning diametrlari bo'yicha taqsimot gistogrammasi.



2) 200 valikning tashqi diametrlari chetlanishlari bo'yicha taqsimlanish poligoni va gistogrammasi quyidagi chizmalarda tasvirlangan (IX.2-rasm, IX.3-rasm):

**4. Bosh to'plam, tanlanma to'plam.**  $x$  ning qabul qilishi mumkin bo'lgan barcha qiymatlari to'plami *bosh to'plam*, bosh to'plamdan ixtiyoriy tartibda ajratib olingan  $n$  ta qiymatdan iborat to'plamni *tanlanma to'plam* deb ataladi.

Ko'p sonli tajribalarda olingan sonli ma'lumotlar bosh to'plami va tanlanmaning arifmetik o'rtacha qiymati haqiqatda bir xil bo'ladi.

Arifmetik o'rtacha qiymatdan  $\varepsilon_i$  chetlanishlarning algebraik yig'indisi nolga teng va istalgan  $x_0$  sonning  $\alpha_i$  chetlanishlari algebraik yig'indisining absolut qiymatidan kichik:

$$\sum \varepsilon_i = \sum (x_i - \bar{x}) = 0, \quad \sum \varepsilon_i \leq |\sum (x - x_0)| = |\sum \alpha_i|. \quad (2)$$

Haqiqatan ham:

$$\begin{array}{rcl} \varepsilon_1 = x_1 - \bar{x} & & \alpha_1 = x_1 - x_0 \\ \varepsilon_2 = x_2 - \bar{x} & & \alpha_2 = x_2 - x_0 \\ + & & + \\ \dots & & \dots \\ \varepsilon_n = x_n - \bar{x} & & \alpha_n = x_n - x_0 \end{array}$$

$$\overline{\sum \varepsilon_i = n\bar{x} - n\bar{x} = 0; \quad \overline{\sum \alpha_i = n\bar{x} - nx_0 = n(\bar{x} - x_0)}, \quad |\sum \alpha_i| \geq 0;$$

$$\sum \varepsilon_i \leq |\sum \alpha_i|$$

(2) tenglikka qaraganda arifmetik o'rtacha qiymatning  $\bar{x}$  o'rtacha xatoligi nolga tengdir. Bu tenglik *eng kichik chetlanishlar prinsipini* ifodalaydi. Undan amaliy hisoblashlarda keng foydalaniladi.

3 - m i s o l. Bir maydondagi ekin tuplarining  $X$  soni besh marta takror sanalib, birinchi marta 7706 ta, so'ng 7721, 7687, 7688, 7718 ta hisoblangan.  $X$  ning  $\bar{x}$  taqribiy qiymati va undan  $\varepsilon_i$  chetlanishlarni topamiz.

**Y e c h i s h.**  $\bar{x} = (7706 + 7721 + 7687 + 7688 + 7718) : 5 = 7704;$

$$\varepsilon_1 = 7706 - 7704 = +2; \quad \varepsilon_2 = 7721 - 7704 = +17; \quad \varepsilon_3 = 7687 - 7704 = -17;$$

$$\varepsilon_4 = 7688 - 7704 = -16; \quad \varepsilon_5 = 7718 - 7704 = +14;$$

$$\bar{\varepsilon} = \frac{2+17-17-16+14}{5} = 0.$$

Agar  $x$  ning qiymati sifatida  $\bar{x}$  emas, balki  $x_i$  lardan ixtiyoriy biri olinganda, chetlanishlar (xatolik) ko'payib ketadi. Masalan,

shu maqsadda  $x_2$  qabul qilinsa, chetlanishlar va o'rtacha xatolik quyidagicha bo'ladi:

$$\alpha_1 = 7706 - 7721 = -15; \alpha_2 = 7721 - 7721 = 0; \alpha_3 = 7687 - 7721 = -34;$$

$$\alpha_4 = 7688 - 7721 = -33; \alpha_5 = 7718 - 7721 = -3;$$

$$\bar{\alpha} = \frac{\sum \alpha_i}{n} = \frac{-85}{5} = -17.$$

Eng kichik kvadratlar prinsipi:  $\bar{x}$  arifmetik o'rta qiymatdan  $\epsilon_i$  chetlanishlar kvadratlarining yig'indisi ixtiyoriy  $x_0$  qiymatdan  $\alpha_i$  chetlanishlar kvadratlarining yig'indisidan kichik:

$$\sum \epsilon_i^2 < \sum \alpha_i^2. \quad (3)$$

Bu prinsip amaliy hisoblashlarda keng qo'llaniladi.

4 - m i s o l. 3-misol shartlaridan foydalanib,  $\bar{x}$  va  $x_2$  larga nisbatan (3) tengsizlikning to'g'riligini tekshirib ko'ramiz.

Y e c h i s h.  $\sum \epsilon_i^2 = (+2)^2 + (+17)^2 + (-17)^2 + (-15)^2 + (+14)^2 = 1034;$

$$\sum \alpha_i^2 = (-15)^2 + 0^2 + (-34)^2 + (-33)^2 + (-3)^2 = 2479; \quad \sum \epsilon_i^2 < \sum \alpha_i^2.$$

O'rtacha kvadratik xatolikning % larda hisoblangan

$$\omega = \frac{\sigma}{\bar{x}} \cdot 100\% \quad (4)$$

nisbiy kattaligi  $\bar{x}$  tasodifiy miqdorning *variatsiya koeffitsiyenti* deyiladi.

5 - m i s o l. Bir detalning  $l$  (sm) uzunligi ikki xil asbob bilan besh martadan o'lchanib, quyidagi natijalar olingan:

I asbob bilan:  $l = 12,9; 12,8; 12,9; 12,9; 12,8;$

II asbob bilan:  $l = 12,6; 12,8; 13,1; 12,8; 13,2.$

Detalning  $\bar{l}$  taqribiy uzunligi, o'rtacha va o'rta kvadratik xatoligi hisoblansin. Qaysi asbob bilan aniqroq natija olingan?

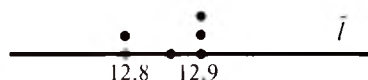

I asbob bilan topilgan natijalarning joylanishi.

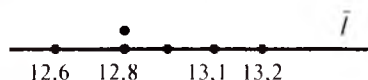

II asbob bilan topilgan natijalarning joylanishi.

IX.4-rasm.

Yechish. I asbob bilan:

$$\bar{T} = 64,3 : 5 = 12,86 \text{ (sm)}, \quad \bar{\varepsilon} = \frac{3 \cdot 0,04 + 2 \cdot (-0,06)}{5} = 0,$$

$$\sigma_{\bar{T},I} = \sqrt{\frac{3 \cdot 0,04^2 + 2 \cdot (-0,06)^2}{5-1}} \approx 0,057, \quad \omega_I = \frac{0,057}{12,86} \cdot 100\% \approx 0,43\%.$$

II asbob bilan:

$$\bar{T} = 64,5 : 5 = 12,9 \text{ (sm)}, \quad \bar{\varepsilon} = \frac{-0,3 - 2 \cdot 0,1 + 0,2 + 0,3}{5} = 0,$$

$$\sigma_{\bar{T},II} = \sqrt{\frac{(-0,3)^2 + 2 \cdot 0,1^2 + 0,2^2 + 0,3^2}{4}} \approx 0,236, \quad \omega_{II} \approx 1,8\%.$$

Birinci asbob bilan topilgan qiymatlar o'rtacha qiymat atrofida zichroq joylashgan (IX.4-rasm). Demak, I asbobning aniqligi katta.



## Mashqlar

**9.70.** 60 ta zotli sovliqning har biridan (3 yilda) quyidagicha qo'zi olingan:

5 4 6 2 4 6 3 3 5 4 5 4 5 2 4 5 4 2 6 4  
4 3 5 4 3 5 4 4 5 4 7 6 4 5 4 3 5 4 4 3  
4 5 5 4 4 3 4 5 4 1 6 5 4 7 5 4 6 4 5 6

Tasodifiy miqdorning taqsimot jadvalini, taqsimot gistogrammasi va poligonini yasang.

**9.71.**  $\beta$  burchak 10 marta takror o'lchanib, quyidagi natijalar olingan:

65°36'12", 65°36'00", 65°35'58", 65°36'04", 65°36'06",  
65°36'09", 65°36'03", 65°36'08", 65°35'54", 65°36'02".

$\bar{\beta}$  o'rtacha qiymatni va uning  $\sigma(\bar{\beta})$  o'rta kvadratik xatoligini toping.

**9.72.** Zarrachaning  $m$  massasini aniqlash maqsadida u 20 marta takror o'lchangan va ushbu natijalar olingan:

4,781 4,779 4,782 4,771 4,764 4,795 4,775 4,7674,7894,778  
4,769 4,772 4,764 4,772 4,791 4,792 4,791 4,7744,7894,776

Massaning taqribiy qiymatini toping va aniqligini baholang.

**9.73.** Tekshirishda 18 ta kasallangan qo'ylar qonida leykotsitlar soni ( $1 \text{ mm}^3$  da ming dona) quyidagicha bo'lgan:

14,4; 16,8; 16,4; 22,1; 15,2; 23,8; 15,4; 18,9; 24,6;

11,8; 15,6; 17,8; 16,8; 19,6; 22,8; 17,2; 20,6; 18,8.

Qo'ylarda o'rta hisobda leykotsitlar soni qancha bo'lgan va uning aniqligini baholang, grafik tasvirini bering.

### **Takrorlashga doir mashqlar**

**9.74.** Ikkita o'yin kubi tashlangan. Tushgan ochkolar (sonlar) yig'indisining 8 ga teng bo'lishi ehtimolliroqmi yoki 10 ga teng bo'lishimi?

**9.75.** Xaltada 1, 2, 3, ..., 9 sonlari bilan belgilangan 9 ta bir xil shar bor. Xaltadan tavakkaliga uchta shar ketma-ket olinadi va sharchalarning nomeri tartib bilan yozib qo'yiladi (olingan sharchalar xaltaga qaytarilmaydi). Shu jarayonda 171 va 197 sonlarining paydo bo'lish ehtimolliklarini toping.

**9.76.** Xaltada 1 dan 9 gacha sonlar bilan raqamlangan 9 ta bir xil sharcha bor. Tavakkaliga 6 sharcha olingan va olinish tartibida tizilgan. Agar: 1) sharchalar olingandan so'ng yana xaltachaga qaytarib solinsa; 2) qaytarib solinmasa, 374521 sonining tizilish ehtimolligini toping.

**9.77.** «Parallelogramm» so'zidagi harflar qirqib olinib, har qaysi harf bitta sharchaga yopishtirilgan va bu sharchalar bir xaltaga solib aralashtirilgan. So'ng xaltadan sharchalar tavakkaliga ketma-ket olindi. O'sha so'zning qaytadan paydo bo'lish ehtimolligini toping.

**9.78.** Xaltada «a», «b», «d», «e», «f» harflari bilan belgilangan 5 ta sharcha bor. Unda tavakkaliga ketma-ket uch sharcha olinib, har safar ularning harfi yozib olingandan so'ng xaltaga qaytarib solinadi. Shu jarayonda birorta ham harfning ikki marta takrorlanmaslik ehtimolligini toping.

**9.79.** 9.78-mashq shartlarida tuzilayotgan yozuvda hech qaysi ikki qo'shni o'rinda bir xil harf bo'lmaslik ehtimolligini toping.

**9.80.** Qutidagi jami 11 ta lotereya biletidan 6 tasi yutuqli. Qutidan tavakkaliga olingan 3 ta biletning yutuqli bo'lish ehtimolligini toping.

**9.81.** «Matematika» so'zining harflari yozilgan kartochkalar ixtiyoriy tartibda tizilgan. Bunda uchta «a» harfining qatorasiga joylashish ehtimolligini toping.

**9.82.** «Lola» soʻzidagi harflar oldin qirqilgan, soʻng ular tavakkaliga bir qatorga tizilgan. Shu soʻzning qaytadan hosil boʻlish ehtimolligini toping.

**9.83.** Qutida 30 ta shar boʻlib, ulardan 20 tasi oq, 10 tasi qora. Tavakkaliga: 1) oq sharni; 2) qora sharni; 3) har xil rangli ikki sharni qutidan chiqarish ehtimolliklarini toping.

**9.84.** Qutida 15 ta yashil, 12 ta qizil va 8 ta koʻk shar bor. Ular ichidan tavakkaliga: 1) 3 ta yashil, 2 ta qizil, 3 ta koʻk sharni olish; 2) 1 ta yashil, 5 ta qizil va 2 ta koʻk sharni olish ehtimolliklarini toping.

**9.85.** Uch otishdan hech boʻlmasa birining nishonga tegish ehtimolligi  $p=0,8$ . Bir otishda nishonga tegish ehtimolligini toping.

**9.86.** Obyektни yoʻq qilish uchun bir bombaning nishonga tegishi yetarli. Toʻrt bombadan har birining obyektga tegish ehtimolligi mos ravishda 0,2; 0,3; 0,4; 0,5 ga teng. Hech boʻlmasa bitta bombaning obyektga tegish ehtimolligini toping.

**9.87.** Bir otishda nishonga tegish ehtimolligi 0,6 ga teng. Besh marta bogʻliqsiz ravishda otish boʻlgan. Hech boʻlmasa ikkita oʻqning nishonga tegish ehtimolligini toping.

**9.88.** Doʻkonda toʻrt turdagi a, b, d, e nomli konfetlar sotiladi. Oʻnta konfetni necha xil usul bilan tanlash mumkin? Tanlangan oʻnta konfetning hammasi 1-tur boʻlishi ehtimolligini toping.

**9.89.** Bemorda ikkita  $H_1$  va  $H_2$  kasallikdan biri boʻlishi mumkin, deb gumon qilinadi. Gumonlarning oʻrinli boʻlish ehtimolliklari  $p(H_1)=0,6$ ,  $p(H_2)=0,4$ . Tashxis qoʻyish maqsadida qilingan analiz natijasida reaksiya ijobiy yoki salbiy boʻlishi mumkin.  $H_1$  holda reaksiya ijobiy boʻlish ehtimolligi 0,9 ga,  $H_2$  uchun esa 0,5 ga teng. Analiz ikki marta oʻtkazilgan va ikki marta ham reaksiya salbiy boʻlib chiqqan ( $A$  hodisa). Har bir kasallikning ehtimolligini toping.

**9.90.** Telefon orqali soʻzlashuv navbatida 5 chaqiriq bor. Har bir chaqiriqda soʻzlashuv ehtimolligi 0,8 ga teng. Ikkitadan ortiq soʻzlashuv boʻlish ehtimolligini toping.

**9.91.** 770 soni 2, 5, 7, 11 dan iborat tub boʻluvchilarga ega. 770 soni 1 va 770 ning oʻzi bilan birgalikda qancha boʻluvchiga ega? 770 sonining tavakkaliga olingan boʻluvchisi tub sondan iborat boʻlish ehtimolligini toping.

**9.92.** 9.91-masalada qaralayotgan son 2210 boʻlsa-chi?



# X BOB

## CHIZIQLI ALGEBRA ELEMENTLARI

### 1-§. Matritsalar va determinantlar

**1. Matritsalar.** Hozirgi paytda fanning ko'plab sohalari (hisoblash matematikasi, fizika, iqtisodiyot va h. k.) da o'zining keng tatbiqlarini topayotgan *matritsalar nazariyasi* elementlari bilan tanishamiz.

*Matritsa* deb, biror tartibda joylashtirilgan sonlarning to'g'ri to'rtburchak ko'rinishidagi jadvaliga aytiladi. Bu sonlar shu matritsaning *elementlari* deyiladi. Odatda matritsalar qavs yoki ikkita vertikal chiziq ichiga olib yoziladi. Masalan, 20 dan kichik barcha tub sonlardan quyidagi matritsani tuzish mumkin:

$$\begin{pmatrix} 2 & 3 & 5 & 7 \\ 11 & 13 & 17 & 19 \end{pmatrix} \text{ yoki } \begin{vmatrix} 2 & 3 & 5 & 7 \\ 11 & 13 & 17 & 19 \end{vmatrix}.$$

Bu matritsa 2 ta satr va 4 ta ustundan iborat bo'lganligi uchun  $2 \times 4$  o'lchamli matritsa deyiladi.

Umuman,  $m$  ta satr va  $n$  ta ustunli to'g'ri to'rtburchakli matritsa  $m$  ta satr va  $n$  ta ustunli matritsa yoki  $m \times n$  o'lchamli matritsa deb ataladi.

$n \times n$  o'lchamli matritsa *kvadrat matritsa*,  $n$  son esa shu kvadrat matritsaning *tartibi* deyiladi. Masalan, bir xonali natural sonlardan tuzilgan  $3 \times 3$  o'lchamli

$$\begin{pmatrix} 1 & 2 & 3 \\ 4 & 5 & 6 \\ 7 & 8 & 9 \end{pmatrix}$$

matritsa *uchinchi tartibli kvadrat matritsa*, bir xonali juft natural sonlardan tuzilgan  $2 \times 2$  o'lchamli

$$\begin{pmatrix} 2 & 4 \\ 6 & 8 \end{pmatrix}$$

matritsa *ikkinchi tartibli kvadrat matritsa*, bitta sondan tuzilgan (15) matritsa esa *birinchi tartibli kvadrat matritsa*dir.

Ba'zan faqat bitta satrga (ustunga) ega bo'lgan matritsalar bilan ham ish ko'rishga to'g'ri keladi. Bunday matritsalar *satr-matritsalar* (*ustun-matritsalar*) deyiladi. Masalan,  $1 \times 5$  o'lchamli

$$(3 \quad \sqrt{2} \quad 7 \quad 0 \quad \sqrt{2})$$

matritsa satr-matritsa,  $3 \times 1$  o'lchamli

$$\begin{pmatrix} \sqrt{5} \\ 7 \\ -8 \end{pmatrix}$$

matritsa esa ustun-matritsa bo'ladi.

Matritsani umumiy holda yozish uchun uning elementlari ikkita indeksli biror harf bilan, masalan,  $a_{ij}$  bilan belgilanadi; bunda birinchi indeks mazkur element turgan satr nomerini, ikkinchi indeks esa ustun nomerini ko'rsatadi. Masalan,  $4 \times 5$  o'lchamli matritsa umumiy holda quyidagicha yoziladi:

$$\begin{pmatrix} a_{11} & a_{12} & a_{13} & a_{14} & a_{15} \\ a_{21} & a_{22} & a_{23} & a_{24} & a_{25} \\ a_{31} & a_{32} & a_{33} & a_{34} & a_{35} \\ a_{41} & a_{42} & a_{43} & a_{44} & a_{45} \end{pmatrix}.$$

Ba'zan matritsa bitta harf orqali belgilanadi. Masalan, elementlari

$a_{ij} (i = 1, 2, j = 1, 2)$  bo'lgan  $\begin{pmatrix} a_{11} & a_{12} \\ a_{21} & a_{22} \end{pmatrix}$  matritsani  $A$  harfi bilan,

elementlari  $b_{ij}$  bo'lgan  $\begin{pmatrix} b_{11} & b_{12} & b_{13} \\ b_{21} & b_{22} & b_{23} \\ b_{31} & b_{32} & b_{33} \end{pmatrix}$  matritsani esa  $B$  harfi bilan belgilasak:

$$A = \begin{pmatrix} a_{11} & a_{12} \\ a_{21} & a_{22} \end{pmatrix}, \quad B = \begin{pmatrix} b_{11} & b_{12} & b_{13} \\ b_{21} & b_{22} & b_{23} \\ b_{31} & b_{32} & b_{33} \end{pmatrix}$$

ko'rinishda bo'ladi.

$m \times n$  o'lchamli ikkita  $A$  va  $B$  matritsaning mos elementlari teng, ya'ni  $a_{ij} = b_{ij} (i = 1, 2, \dots, m, j = 1, 2, \dots, n)$  bo'lsa,  $A$  va  $B$  matritsalar teng deyiladi va  $A = B$  ko'rinishda belgilanadi. Masalan,

$$\begin{pmatrix} 4 & 5 & \sqrt{3} \\ 1 & 2 & 8 \end{pmatrix} = \begin{pmatrix} 4 & \sqrt{25} & \frac{3}{\sqrt{3}} \\ 1 & 2 & \frac{24}{3} \end{pmatrix}.$$

Har qanday matritsalar uchun «kichik», «katta» munosabatlari, shuningdek, har xil o'lchamli matritsalar uchun «tenglik» munosabati ma'noga ega emas.

Umuman, matritsalaridan turli hisoblashlarni bajarishda foydalaniladi. Xususan, ular ustida turli almashtirishlarni bajarish orqali tenglamalar sistemalarini nisbatan oson yechish mumkin. Bu haqda keyinroq to'xtalamiz.

Endi matritsalar ustida bajariladigan amallar bilan tanishamiz.

*Matritsalarini qo'shish.* Har xil o'lchamli matritsalar uchun qo'shish amali aniqlanmaydi. Bir xil  $m \times n$  o'lchamli ikkita  $A$  va  $B$  matritsalarining yig'indisi deb, elementlari  $A$  va  $B$  matritsalar mos elementlari yig'indisiga teng bo'lgan  $m \times n$  o'lchamli matritsaga aytiladi.

1 - misol.  $A = \begin{pmatrix} 1 & 2 \\ -5 & 4 \end{pmatrix}$  va  $B = \begin{pmatrix} -1 & -2 \\ 5 & -4 \end{pmatrix}$  matritsalar yig'indisini topamiz.

$$\begin{aligned} \text{Yechish. } A + B &= \begin{pmatrix} 1 & 2 \\ -5 & 4 \end{pmatrix} + \begin{pmatrix} -1 & -2 \\ 5 & -4 \end{pmatrix} = \begin{pmatrix} 1 + (-1) & 2 + (-2) \\ (-5) + 5 & 4 + (-4) \end{pmatrix} = \\ &= \begin{pmatrix} 0 & 0 \\ 0 & 0 \end{pmatrix}. \end{aligned}$$

$A$  va  $B$  matritsalarini qo'shish natijasida barcha elementlari 0 ga teng bo'lgan matritsa hosil bo'ldi.

Barcha elementlari nollardan iborat bo'lgan matritsa *nol-matritsa* deyiladi va  $O$  harfi bilan belgilanadi:

$$O = \begin{pmatrix} 0 & 0 & 0 & \dots & 0 \\ 0 & 0 & 0 & \dots & 0 \\ \dots & \dots & \dots & \dots & \dots \\ 0 & 0 & 0 & \dots & 0 \end{pmatrix}.$$

$m \times n$  o'lchamli nol-matritsa bilan  $m \times n$  o'lchamli har qanday  $A$  matritsaning yig'indisi  $A$  matritsaga teng:

$$A + O = A.$$

$m \times n$  o'lchamli har qanday  $A$  matritsaning har bir elementini unga qarama-qarshi songa almashtirishdan hosil bo'lgan matritsa



$-A$  bilan belgilanadi.  $A$  va  $-A$  matritsalar *qarama-qarshi matritsalar* deyiladi. Ular uchun  $A + (-A) = O$  tenglik o‘rinlidir.

Bir xil  $m \times n$  o‘lchamli  $A$ ,  $B$  va  $C$  matritsalar uchun quyidagi tasdiqlar o‘rinli:

$$1) A + B = B + A;$$

$$2) A + (B + C) = (A + B) + C.$$

Matritsalarini qo‘shish amaliga nisbatan teskari amal — *matritsalarini ayirishni* qaraymiz. Har biri  $m \times n$  o‘lchamli bo‘lgan  $A$  va  $B$  matritsalar uchun  $B + C = A$  tenglik o‘rinli bo‘lsa,  $C$  matritsaning  $c_{ij}$  elementlari  $c_{ij} = a_{ij} - b_{ij}$  tenglik bo‘yicha aniqlanadi.  $C$  matritsa  $A$  va  $B$  matritsalarining *ayirmasi* deyiladi va  $A - B$  ko‘rinishda belgilanadi.

$$2\text{-misol. } \begin{pmatrix} 3 & 4 & 5 \\ 1 & 2 & 3 \end{pmatrix} - \begin{pmatrix} 2 & 1 & 0 \\ 3 & 4 & 5 \end{pmatrix} = \begin{pmatrix} 3-2 & 4-1 & 5-0 \\ 1-3 & 2-4 & 3-5 \end{pmatrix} = \begin{pmatrix} 1 & 3 & 5 \\ -2 & -2 & -2 \end{pmatrix}.$$

*Matritsani songa ko‘paytirish.*  $m \times n$  o‘lchamli  $A$  matritsaning hamma elementlarini  $\alpha \in R$  songa ko‘paytirishdan hosil bo‘ladigan matritsa  $A$  *matritsaning  $\alpha$  songa ko‘paytmasi* deyiladi va  $\alpha A$  yoki  $A\alpha$  ko‘rinishda belgilanadi.

$$3\text{-misol. } 3 \cdot \begin{pmatrix} 1 & 2 \\ 3 & 4 \end{pmatrix} = \begin{pmatrix} 3 \cdot 1 & 3 \cdot 2 \\ 3 \cdot 3 & 3 \cdot 4 \end{pmatrix} = \begin{pmatrix} 3 & 6 \\ 9 & 12 \end{pmatrix}.$$

Matritsani songa ko‘paytirish ta‘rifidan va sonlar ustidagi tegishli amallar xossalaridan har biri  $m \times n$  o‘lchamli bo‘lgan  $A$  va  $B$  matritsalar hamda har qanday  $\alpha$ ,  $\beta$  haqiqiy sonlar uchun quyidagi tengliklar o‘rinli bo‘lishi kelib chiqadi:

$$3) (\alpha + \beta)A = \alpha A + \beta A;$$

$$4) (\alpha\beta)A = \alpha(\beta A);$$

$$5) \alpha(A + B) = \alpha A + \alpha B;$$

$$6) 1 \cdot A = A.$$

*Matritsalarini ko‘paytirish.*  $1 \times k$  o‘lchamli  $A$  satr-matritsa va  $k \times 1$  o‘lchamli  $B$  ustun-matritsa berilgan bo‘lsin:

$$A = (a_{11} \quad a_{12} \quad \dots \quad a_{1k}), \quad B = \begin{pmatrix} b_{11} \\ b_{21} \\ \dots \\ b_{k1} \end{pmatrix}.$$

$1 \times k$  o‘lchamli  $A$  satr-matritsaning  $k \times 1$  o‘lchamli  $B$  ustun-matritsaga ko‘paytmasi deb, shu matritsalar mos elementlari

ko'paytmalarining yig'indisiga teng bo'lgan  $1 \times 1$  o'lchamli matritsaga, ya'ni

$$AB = a_{11}b_{11} + a_{12}b_{21} + \dots + a_{1k}b_{k1}$$

songa aytiladi:

$$(a_{11} \ a_{12} \ \dots \ a_{1k}) \cdot \begin{pmatrix} b_{11} \\ b_{21} \\ \dots \\ b_{k1} \end{pmatrix} = a_{11}b_{11} + a_{12}b_{21} + \dots + a_{1k}b_{k1}$$

$$4\text{-misol. } (2 \ -3 \ 1) \cdot \begin{pmatrix} -4 \\ 3 \\ 1 \end{pmatrix} = 2 \cdot (-4) + (-3) \cdot 3 + 1 \cdot 1 = -16.$$

$m \times k$  o'lchamli  $A$  matritsa va  $k \times n$  o'lchamli  $B$  matritsaning, ya'ni birinchisining ustunlari soni ikkinchisining satrlari soniga teng bo'lgan  $A$  va  $B$  matritsalarining ko'paytmasi deb, har bir  $c_{ij}$  elementi birinchi ko'paytuvchining  $i$ -satrini ikkinchi ko'paytuvchining  $j$ -ustuniga ko'paytirishdan hosil qilinadigan  $m \times n$  o'lchamli  $C = AB$  matritsaga aytiladi.

5-misol.  $A = \begin{pmatrix} 1 \\ 2 \\ 3 \end{pmatrix}$ ,  $B = (7 \ 3 \ 9)$  bo'lsa,  $AB$  va  $BA$  matritsalarini topamiz.

$$\text{Yechish. } AB = \begin{pmatrix} 1 \\ 2 \\ 3 \end{pmatrix} \cdot (7 \ 3 \ 9) = \begin{pmatrix} 1 \cdot 7 & 1 \cdot 3 & 1 \cdot 9 \\ 2 \cdot 7 & 2 \cdot 3 & 2 \cdot 9 \\ 3 \cdot 7 & 3 \cdot 3 & 3 \cdot 9 \end{pmatrix} = \begin{pmatrix} 7 & 3 & 9 \\ 14 & 6 & 18 \\ 21 & 9 & 27 \end{pmatrix}.$$

$$BA = (7 \ 3 \ 9) \cdot \begin{pmatrix} 1 \\ 2 \\ 3 \end{pmatrix} = 7 \cdot 1 + 3 \cdot 2 + 9 \cdot 3 = 40.$$

$$6\text{-misol. } \begin{pmatrix} 7 & 2 \\ 3 & 1 \end{pmatrix} \cdot \begin{pmatrix} 1 & -2 \\ -3 & 7 \end{pmatrix} = \begin{pmatrix} 7 \cdot 1 + 2 \cdot (-3) & 7 \cdot (-2) + 2 \cdot 7 \\ 3 \cdot 1 + 1 \cdot (-3) & 3 \cdot (-2) + 1 \cdot 7 \end{pmatrix} = \begin{pmatrix} 1 & 0 \\ 0 & 1 \end{pmatrix}.$$

7-misol.

$$\begin{pmatrix} 1 & 2 & 3 \\ 1 & 3 & 2 \\ 0 & 1 & 2 \end{pmatrix} \cdot \begin{pmatrix} 1 & 3 \\ 5 & 7 \\ 0 & 1 \end{pmatrix} = \begin{pmatrix} 1 \cdot 1 + 2 \cdot 5 + 3 \cdot 0 & 1 \cdot 3 + 2 \cdot 7 + 3 \cdot 1 \\ 1 \cdot 1 + 3 \cdot 5 + 2 \cdot 0 & 1 \cdot 3 + 3 \cdot 7 + 2 \cdot 1 \\ 0 \cdot 1 + 1 \cdot 5 + 2 \cdot 0 & 0 \cdot 3 + 1 \cdot 7 + 2 \cdot 1 \end{pmatrix} = \begin{pmatrix} 11 & 20 \\ 16 & 26 \\ 5 & 9 \end{pmatrix}$$

$m \times n$  o'lchamli  $A$  va  $k \times p$  o'lchamli  $B$  matritsa uchun  $n \neq k$  bo'lsa,  $AB$  ko'paytma ma'noga ega bo'lmaydi.

Matritsalarini ko'paytirish amali o'rin almashtirish xossasiga ega emas (5-misol), lekin guruhlash va taqsimot xossalriga ega:

- 1)  $A(BC) = (AB)C$ ;
- 2)  $(A + B)C = AC + BC$ .

Matritsalarini ko'paytirish amali bir nechta ko'paytuvchilar bo'lgan hol uchun ham o'rinli bo'lishi mumkin. Masalan, o'lchamlari mos ravishda  $m \times n$ ,  $n \times k$ ,  $k \times c$  bo'lgan  $A$ ,  $B$ ,  $C$  matritsalar uchun  $ABC$  ko'paytma quyidagicha aniqlanadi:

$$ABC = (AB)C.$$

Matritsalarini ko'paytirish amalining aniqlanishidan ko'rindiki,  $A$  matritsani o'z-o'ziga ko'paytirish amali kvadrat matritsalar uchungina bajarilishi mumkin.

$A$  matritsa  $n$ -tartibli kvadrat matritsa bo'lsin.  $\underbrace{A \cdot A \cdot \dots \cdot A}_{k \text{ marta}}$  ko'paytma (bu yerda  $k \in \mathbb{N}$ ,  $k > 1$ )  $A$  matritsaning  $k$ -darajasi deyiladi va  $A^k$  bilan belgilanadi:

$$A^k = \underbrace{A \cdot A \cdot \dots \cdot A}_{k \text{ marta}}.$$

Bundan tashqari, har qanday  $A$  matritsaning 1-darajasi o'ziga teng deb qabul qilinadi, ya'ni

$$A^1 = A.$$

8 - misol.  $A = \begin{pmatrix} 1 & 1 \\ -1 & 1 \end{pmatrix}$  matritsaning kvadrati (ikkinchi darajasi) va kubi (uchinchi darajasi)ni topamiz.

$$\begin{aligned} \text{Yechish. } A^2 &= \begin{pmatrix} 1 & 1 \\ -1 & 1 \end{pmatrix} \cdot \begin{pmatrix} 1 & 1 \\ -1 & 1 \end{pmatrix} = \begin{pmatrix} 1 \cdot 1 - 1 \cdot 1 & 1 \cdot 1 + 1 \cdot 1 \\ -1 \cdot 1 - 1 \cdot 1 & -1 \cdot 1 + 1 \cdot 1 \end{pmatrix} = \\ &= \begin{pmatrix} 0 & 2 \\ -2 & 0 \end{pmatrix}; \end{aligned}$$

$$A^3 = A^2 \cdot A = \begin{pmatrix} 0 & 2 \\ -2 & 0 \end{pmatrix} \cdot \begin{pmatrix} 1 & 1 \\ -1 & 1 \end{pmatrix} = \begin{pmatrix} 0 - 2 & 0 + 2 \\ -2 - 0 & -2 + 0 \end{pmatrix} = \begin{pmatrix} -2 & 2 \\ -2 & -2 \end{pmatrix}.$$

Agar ko'paytuvchilardan biri nol-matritsa bo'lib, ko'paytma ma'noga ega bo'lsa, ko'paytirish natijasida nol-matritsa hosil bo'ladi, lekin ko'paytmada nol-matritsa hosil bo'lishi uchun ko'paytuvchilar orasida albatta nol-matritsa mavjud bo'lishi shart

emas. Masalan, nolmas  $A = \begin{pmatrix} 1 & 0 \\ 0 & 0 \end{pmatrix}$  va  $B = \begin{pmatrix} 0 & 0 \\ 1 & 1 \end{pmatrix}$  matritsalar uchun  $AB = O$  tenglik o'rinli.

Matritsalarini ko'paytirish amaliga nisbatan teskari amal mavjud emasligini, ya'ni matritsalar uchun bo'lish amali qaralmasligini eslatib o'tamiz.

*Matritsani transponirlash (lotincha – transponere – o'rin almash- tirib qo'yish).*  $m \times n$  o'lchamli  $A$  matritsa berilgan bo'lsin:

$$A = \begin{pmatrix} a_{11} & a_{12} & \dots & a_{1n} \\ a_{21} & a_{22} & \dots & a_{2n} \\ \dots & \dots & \dots & \dots \\ a_{m1} & a_{m2} & \dots & a_{mn} \end{pmatrix}.$$

*A matritsani transponirlash* deb, uning satr va ustunlari nomer- larini o'zgartirmay, satrlari va ustunlarining o'rnini almashtirib yozishga aytiladi.

$A$  matritsani transponirlash natijasida  $n \times m$  o'lchamli matritsa hosil bo'ladi. Uni  $A^T$  bilan belgilaymiz:

$$A^T = \begin{pmatrix} a_{11} & a_{21} & \dots & a_{m1} \\ a_{12} & a_{22} & \dots & a_{m2} \\ \dots & \dots & \dots & \dots \\ a_{1n} & a_{2n} & \dots & a_{mn} \end{pmatrix}.$$

9-misol.  $A = \begin{pmatrix} 1 & 4 & 3 \\ -1 & 5 & 6 \end{pmatrix}$  bo'lsa,  $A^T = \begin{pmatrix} 1 & -1 \\ 4 & 5 \\ 3 & 6 \end{pmatrix}$  bo'ladi.

Matritsani transponirlash amalining xossalarini keltiramiz:

$$(A^T)^T = A; \quad (A + B)^T = A^T + B^T; \quad (\lambda A)^T = \lambda A^T; \quad (AB)^T = B^T \cdot A^T.$$



## Mashqlar

**10.1.** Uchta zavodning har biri beshta har xil turdagi mahsulot ishlab chiqarayotgan bo'lsin.  $i$ -zavod ( $i = 1, 2, 3$ ) tomonidan yil davomida ishlab chiqarilgan  $j$ -tur ( $j = 1, 2, 3, 4, 5$ ) mahsulot miqdorini  $a_{ij}$  bilan belgilaymiz. Zavodlarning yillik ishlab chiqarishi haqidagi hisobotni  $3 \times 5$  o'lchamli matritsa ko'rinishda yozing.

**10.2.** Barcha elementlari 1 ga teng bo'lgan  $1 \times 4$  o'lchamli  $A$  satr matritsani va barcha elementlari 0 ga teng bo'lgan  $4 \times 1$  o'lchamli  $B$  ustun matritsani yozing.

**10.3.** Birinchi satrida faqat 3 lar, ikkinchi satrida esa faqat 4 lar turadigan  $2 \times 5$  o'lchamli  $C$  matritsani yozing.

**10.4.** Amallarni bajaring:

- 1)  $(0 \ 3 \ 4 \ 5) + (3 \ 2 \ 1 \ 4)$ ;
- 2)  $(2 \ 1 \ 8 \ 9) - (1 \ 4 \ 5 \ 30)$ ;
- 3)  $3 \cdot (4 \ 5 \ 6 \ 7) + 4 \cdot (8 \ 9 \ 10 \ 11)$ ;
- 4)  $2 \cdot (1 \ 3 \ 2 \ 8) - 3 \cdot (2 \ 3 \ 9 \ 11)$ .

**10.5.** Barcha elementlari  $-3$  ga teng bo'lgan uchinchi tartibli kvadrat matritsa bilan barcha elementlari  $4$  ga teng bo'lgan uchinchi tartibli kvadrat matritsaning yig'indisini toping.

**10.6.** Qo'shishni bajaring:

1)  $\begin{pmatrix} 2 & 1 \\ 3 & 2 \end{pmatrix} + \begin{pmatrix} 1 & -1 \\ 1 & 1 \end{pmatrix}$ ;

2)  $\begin{pmatrix} 1 & 2 & 3 \\ 4 & 5 & 6 \\ 7 & 8 & 9 \end{pmatrix} + \begin{pmatrix} 3 & 2 & 1 \\ 6 & 5 & 4 \\ 9 & 8 & 7 \end{pmatrix}$ ;

3)  $\begin{pmatrix} 1 & 0 & 0 & 1 \\ 1 & 2 & 0 & 1 \\ 3 & 4 & 5 & 6 \\ 7 & 8 & 9 & 10 \end{pmatrix} + \begin{pmatrix} 2 & 3 & 4 & 5 \\ 6 & 7 & 8 & 9 \\ 10 & 11 & 12 & 13 \\ 14 & 15 & 16 & 17 \end{pmatrix}$ ;

4)  $\begin{pmatrix} 4 & 0 & 0 & 0 & 0 \\ 0 & 0 & 0 & 0 & 0 \\ 0 & 0 & 4 & 0 & 0 \\ 0 & 0 & 0 & 0 & 0 \\ 0 & 0 & 0 & 0 & 4 \end{pmatrix} + \begin{pmatrix} 1 & 0 & 0 & 0 & 0 \\ 0 & 1 & 0 & 0 & 0 \\ 0 & 0 & 1 & 0 & 0 \\ 0 & 0 & 0 & 1 & 0 \\ 0 & 0 & 0 & 0 & 1 \end{pmatrix}$ .

**10.7.** Agar  $A = \begin{pmatrix} 1 & 0 & -2 \\ 3 & 4 & 5 \end{pmatrix}$  va  $B = \begin{pmatrix} -3 & 2 & 1 \\ -1 & 1 & 4 \end{pmatrix}$  bo'lsa,

- 1)  $A + B$ ; 2)  $B - A$ ; 3)  $2A + 4B$ ; 4)  $3A - 2B$  ni toping.

**10.8.** Amallarni bajaring:  $3 \cdot \begin{pmatrix} 1 & 2 & -1 \\ 1 & 3 & 1 \end{pmatrix} + 2 \cdot \begin{pmatrix} -1 & 3 & 4 \\ 2 & 2 & 1 \end{pmatrix} - 3 \cdot \begin{pmatrix} 2 & 3 & 4 \\ -1 & 2 & 1 \end{pmatrix}$ .

### 10.9. Agar

$$1) A = \begin{pmatrix} 0 & 1 & 2 \\ 3 & 0 & 2 \\ 2 & 1 & 3 \end{pmatrix}, \quad B = \begin{pmatrix} 1 & 2 & 3 \\ -1 & 0 & 0 \\ 0 & 0 & 4 \end{pmatrix} \text{ va } A + 3C = 5B;$$

$$2) A = \begin{pmatrix} -1 & 1 & 2 \\ 0 & 0 & 3 \\ 1 & 0 & 4 \end{pmatrix}, \quad B = \begin{pmatrix} 1 & -1 & 1 \\ 0 & 0 & 2 \\ 1 & 3 & 4 \end{pmatrix} \text{ va } 2A + 5C = 4B;$$

$$3) A = \begin{pmatrix} 1 & 2 & 3 \\ 0 & 0 & 0 \\ 3 & 1 & 4 \end{pmatrix}, \quad B = \begin{pmatrix} 2 & -2 & 0 \\ 3 & 0 & 0 \\ 0 & 1 & 2 \end{pmatrix} \text{ va } 3A + 4C = 5B \text{ bo'lsa,}$$

$C$  matritsani toping.

**Yechish.** 3)  $3A + 4C = 5B$  matritsaviy tenglamaning har ikki tomoniga  $-3A$  matritsani qo'shib,  $4C = 5B - 3A$  tenglamaga va bundan,

$$4C = \begin{pmatrix} 7 & -16 & -9 \\ 15 & 0 & 0 \\ -9 & 2 & -2 \end{pmatrix} \text{ ga yoki } C = \begin{pmatrix} \frac{7}{4} & -4 & -\frac{9}{4} \\ \frac{15}{4} & 0 & 0 \\ -\frac{9}{4} & \frac{1}{2} & -\frac{1}{2} \end{pmatrix} \text{ ga ega bo'la-$$

miz.

**10.10.** Agar  $A = (1 \ 3 \ 5)$  va  $B = \begin{pmatrix} 1 \\ 2 \\ 3 \end{pmatrix}$  bo'lsa,  $AB$  va  $BA$  matritsalarini toping.

**10.11.** Agar  $A = \begin{pmatrix} 1 \\ 2 \\ 9 \end{pmatrix}$  va  $B = (2 \ 3 \ 10)$  bo'lsa,  $AB = BA$  tenglikni tekshiring.

**10.12.**  $A = \begin{pmatrix} 1 & 0 & -1 \\ 2 & 1 & 0 \end{pmatrix}$  va  $B = \begin{pmatrix} -2 & 0 \\ 3 & 2 \\ -1 & 1 \end{pmatrix}$  bo'lsa,  $AB$  va  $BA$  matritsalarini toping.

**10.13.**  $A = \begin{pmatrix} \cos \alpha & \sin \alpha \\ \sin \alpha & \cos \alpha \end{pmatrix}$  va  $B = \begin{pmatrix} \cos \beta & \sin \beta \\ \sin \beta & \cos \beta \end{pmatrix}$  (bu yerda  $\alpha \in R$ ) matritsalar uchun  $AB = BA$  tenglik bajarilishini ko'rsating.

**10.14.** Ko'paytirishni bajaring:

1)  $\begin{pmatrix} 2 & 1 \\ 4 & 3 \end{pmatrix} \cdot \begin{pmatrix} 1 & 0 \\ 0 & 2 \end{pmatrix}$ ;      2)  $\begin{pmatrix} 3 & 5 \\ 6 & 1 \end{pmatrix} \cdot \begin{pmatrix} 1 & 2 \\ 3 & -4 \end{pmatrix}$ ;

3)  $\begin{pmatrix} 1 & 2 & 3 \\ 4 & 5 & 1 \\ 1 & 2 & 1 \end{pmatrix} \cdot \begin{pmatrix} -1 & -2 & -3 \\ -1 & -3 & -4 \\ 1 & 2 & 3 \end{pmatrix}$ ;      4)  $\begin{pmatrix} 3 & 1 & 1 \\ 2 & 1 & 2 \\ 1 & 2 & 3 \end{pmatrix} \cdot \begin{pmatrix} 1 & 0 & 0 \\ 0 & 1 & 1 \\ 0 & 0 & 1 \end{pmatrix}$ ;

5)  $\begin{pmatrix} a & b & c \\ c & b & a \\ 1 & 1 & 1 \end{pmatrix} \cdot \begin{pmatrix} 1 & a & c \\ 1 & b & b \\ 1 & c & a \end{pmatrix}$ ;      6)  $\begin{pmatrix} 0 & a & b & c \\ -a & 0 & d & e \\ -b & -d & 0 & f \\ -c & -e & -f & 0 \end{pmatrix} \cdot \begin{pmatrix} 0 & -f & e & -d \\ f & 0 & -c & b \\ -e & c & 0 & -a \\ d & -b & a & 0 \end{pmatrix}$ ;

7)  $\begin{pmatrix} 2 & 1 & 1 \\ 3 & 0 & 1 \end{pmatrix} \cdot \begin{pmatrix} 3 & 1 \\ 2 & 1 \\ 1 & 0 \end{pmatrix}$ ;      8)  $\begin{pmatrix} 3 & 2 & 2 \\ 0 & 1 & 1 \end{pmatrix} \cdot \begin{pmatrix} 1 \\ 3 \\ 5 \end{pmatrix}$ .

**10.15.**  $A = \begin{pmatrix} 0 & 1 \\ -1 & 0 \end{pmatrix}$  va  $E = \begin{pmatrix} 1 & 0 \\ 0 & 1 \end{pmatrix}$  matritsalar berilgan.  $A^2 = -E$ , $E^2 = E$  tengliklar o'rinli ekanligini isbotlang.**10.16.** Amallarni bajaring:

1)  $\begin{pmatrix} 2 & 1 & 1 \\ 3 & 0 & 0 \\ 0 & 2 & 0 \end{pmatrix}^2$ ;      2)  $\begin{pmatrix} 1 & 1 \\ 0 & 1 \end{pmatrix}^4$ ;      3)  $\begin{pmatrix} 2 & 1 \\ 1 & 2 \end{pmatrix}^3$ ;      4)  $\begin{pmatrix} 1 & 2 \\ 3 & 4 \end{pmatrix}^2$ .

**10.17.**  $A = \begin{pmatrix} 1 & 1 \\ 1 & 0 \end{pmatrix}$  va  $B = \begin{pmatrix} 2 & 0 \\ 1 & 1 \end{pmatrix}$  bo'lsa,  $A^3 + B^3$  matritsani toping.**10.18.** 1)  $P(x) = 2x^2 - 5x$  ko'phad va  $A = \begin{pmatrix} 1 & 1 \\ -1 & 1 \end{pmatrix}$  matritsa berilgan.  $P(A) = 2A^2 - 5A$  ni toping;2)  $P(x) = x^2 - 5x + 6$  ko'phad,  $A = \begin{pmatrix} 0 & 1 \\ 1 & 0 \end{pmatrix}$  va  $E = \begin{pmatrix} 1 & 0 \\ 0 & 1 \end{pmatrix}$  matritsalar berilgan.  $P(A) = A^2 - 5A + 6E$  ni toping.

**10.19.**  $A^T$  matritsani toping, bunda

1)  $A = \begin{pmatrix} 2 & 1 \end{pmatrix}$ ;    2)  $A = \begin{pmatrix} 4 \\ 1 \\ 3 \end{pmatrix}$ ;    3)  $A = \begin{pmatrix} 0 & 1 \\ 3 & 4 \end{pmatrix}$ ;

4)  $A = \begin{pmatrix} 1 & 0 & 2 \\ 1 & 1 & 1 \\ 2 & -1 & 1 \end{pmatrix}$ ;    5)  $A = \begin{pmatrix} 3 & 2 & 1 \\ 2 & 3 & 4 \end{pmatrix}$ ;    6)  $A = \begin{pmatrix} 0 & 1 & 0 & 0 \\ 0 & 0 & 1 & 0 \\ 0 & 0 & 0 & 1 \\ 0 & 0 & 1 & 0 \end{pmatrix}$ ;

7)  $A = \begin{pmatrix} 1 & 2 & 3 & 7 \\ 4 & 5 & 6 & 8 \\ 1 & 1 & 2 & 0 \end{pmatrix}$ ;    8)  $A = \begin{pmatrix} 1 & 2 & 3 & 4 \\ 0 & 1 & 2 & 3 \\ 1 & 2 & 3 & 4 \\ a & \beta & \gamma & \delta \end{pmatrix}$ .

**10.20.** Matritsani transponirlash amalining xossalarini

$A = \begin{pmatrix} 1 & 2 \\ 3 & 4 \end{pmatrix}$  va  $B = \begin{pmatrix} 1 & 3 \\ 5 & 4 \end{pmatrix}$  matritsalar misolida tekshirib ko'ring.

**2. Kvadrat matritsaning determinanti** (*lotincha «determinans» – aniqlovchi*). Biz ikkinchi va uchinchi tartibli determinantlar hamda ularning asosiy xossalari bilan tanishmiz.

Bu bandda ixtiyoriy  $n$  natural son uchun  $n$ - tartibli determinant tushunchasini aniqlash usulini qarab chiqamiz.

$n$ - tartibli  $A$  kvadrat matritsa berilgan bo'lsin:

$$A = \begin{pmatrix} a_{11} & a_{12} & \dots & a_{1n} \\ a_{21} & a_{22} & \dots & a_{2n} \\ \dots & \dots & \dots & \dots \\ a_{n1} & a_{n2} & \dots & a_{nn} \end{pmatrix} \quad (1)$$

$n = 1$ ,  $n = 2$ ,  $n = 3$  va  $n = 4$  bo'lgan hollarni alohida-alohida qarab chiqaylik:

a)  $n = 1$  bo'lsin. U holda birinchi tartibli kvadrat matritsaga, ya'ni  $a_{11}$  songa egamiz. Bu matritsaning determinanti  $a_{11}$  songa teng deb hisoblanadi;

b)  $n = 2$  bo'lsa, ikkinchi tartibli

$$\begin{pmatrix} a_{11} & a_{12} \\ a_{21} & a_{22} \end{pmatrix} \quad (2)$$

kvadrat matritsa hosil bo'ladi. (2) matritsaning determinanti deb,



$$\begin{vmatrix} a_{11} & a_{12} \\ a_{21} & a_{22} \end{vmatrix} = a_{11}a_{22} - a_{21}a_{12}$$

soniga aytiladi;

d)  $n = 3$  bo'lsa, uchinchi tartibli

$$\begin{pmatrix} a_{11} & a_{12} & a_{13} \\ a_{21} & a_{22} & a_{23} \\ a_{31} & a_{32} & a_{33} \end{pmatrix} \quad (3)$$

kvadrat matritsa hosil bo'ladi. (3) matritsaning determinanti deb,

$$\begin{vmatrix} a_{11} & a_{12} & a_{13} \\ a_{21} & a_{22} & a_{23} \\ a_{31} & a_{32} & a_{33} \end{vmatrix} = a_{11}a_{22}a_{33} + a_{12}a_{23}a_{31} + a_{21}a_{32}a_{13} - a_{13}a_{22}a_{31} - a_{21}a_{12}a_{33} - a_{32}a_{23}a_{11}$$

soniga aytiladi;

g)  $n = 4$  bo'lsin. U holda to'rtinchi tartibli

$$A = \begin{pmatrix} a_{11} & a_{12} & a_{13} & a_{14} \\ a_{21} & a_{22} & a_{23} & a_{24} \\ a_{31} & a_{32} & a_{33} & a_{34} \\ a_{41} & a_{42} & a_{43} & a_{44} \end{pmatrix} \quad (4)$$

kvadrat matritsaga ega bo'lamiz.

Uchinchi tartibli determinantlar yordamida, (4) matritsaga to'la aniqlangan son — to'rtinchi tartibli determinant mos qo'yilishi mumkin. Bu quyidagicha amalga oshiriladi.

(4) matritsada ixtiyoriy bir elementni tanlab, shu element turgan satrni va ustunni o'chiramiz. O'chirilmay qolgan elementlar o'z joylashuvini saqlagan holda, uchinchi tartibli kvadrat matritsa hosil qiladi. Shu kvadrat matritsaning determinanti tanlangan *elementning minori* deyiladi.  $a_{ij}$  elementning minori  $M_{ij}$  ko'rinishida belgilanadi.

$M_{ij}$  sonini  $(-1)^{i+j}$  soniga ko'paytirishdan hosil bo'lgan son  $a_{ij}$  *elementning algebraik to'ldiruvchisi* deyiladi va  $A_{ij}$  bilan belgilanadi. Ta'rifga ko'ra

$$A_{ij} = (-1)^{i+j} M_{ij}.$$

1 - misol.  $\begin{pmatrix} 5 & 20 & 5 & 15 \\ 2 & 4 & 4 & 8 \\ 1 & 4 & 3 & 7 \\ 4 & -3 & 9 & 3 \end{pmatrix}$  matritsa berilgan.  $M_{43}$  va  $A_{43}$  ni

topamiz.

Yechish.  $a_{43} = 9$  elementning minorini va algebraik to'ldiruvchisini topish talab qilinmoqda.  $M_{43}$  ni topish uchun matritsadagi to'rtinchi satrni va uchinchi ustunni o'chiramiz:

$$\begin{pmatrix} 5 & 20 & 5 & 15 \\ 2 & 4 & 4 & 8 \\ 1 & 4 & 3 & 7 \\ 4 & -3 & 9 & 3 \end{pmatrix}$$

O'chirilmay qolgan elementlardan hosil bo'ladigan uchinchi tartibli kvadrat matritsaning determinanti:

$$\begin{vmatrix} 5 & 20 & 15 \\ 2 & 4 & 8 \\ 1 & 4 & 7 \end{vmatrix} = -80.$$

Bundan  $M_{43} = -80$  va  $A_{43} = (-1)^{4+3} M_{43} = 80$  hosil qilinadi.

(4) matritsaning determinanti deb,  $a_{11}A_{11} + a_{12}A_{12} + a_{13}A_{13} + a_{14}A_{14}$  songa aytiladi. (4) matritsaning determinantini

$$|A| = \begin{vmatrix} a_{11} & a_{12} & a_{13} & a_{14} \\ a_{21} & a_{22} & a_{23} & a_{24} \\ a_{31} & a_{32} & a_{33} & a_{34} \\ a_{41} & a_{42} & a_{43} & a_{44} \end{vmatrix}$$

ko'rinishda belgilaymiz. U *to'rtinchi tartibli determinant* deb ataladi.

Ixtiyoriy  $A$  kvadrat matritsaning determinanti  $|A|$  yoki  $\det A$  ko'rinishda belgilanishini eslatib o'tamiz.

Ikkinchi tartibli determinantlar xossalari ixtiyoriy  $n$ -tartibli ( $n \geq 3$ ) determinantlar uchun ham o'rinlidir. Shu xossalarni keltiramiz.

1. Agar determinantda satrlari mos ustunlari bilan o'rin almashtirilsa, uning qiymati o'zgarmaydi, ya'ni

$$\begin{vmatrix} a_{11} & a_{12} & \dots & a_{1n} \\ a_{21} & a_{22} & \dots & a_{2n} \\ \dots & \dots & \dots & \dots \\ a_{n1} & a_{n2} & \dots & a_{nn} \end{vmatrix} = \begin{vmatrix} a_{11} & a_{21} & \dots & a_{n1} \\ a_{12} & a_{22} & \dots & a_{n2} \\ \dots & \dots & \dots & \dots \\ a_{1n} & a_{2n} & \dots & a_{nn} \end{vmatrix}.$$

2. Ikki satr (yoki ustun)ning o'rnini almashtirish natijasida determinantning ishorasi qarama-qarshi ishoraga o'zgaradi, absolut qiymati esa o'zgarmaydi, ya'ni

$$\begin{vmatrix} a_{11} & a_{12} & \dots & a_{1n} \\ a_{21} & a_{22} & \dots & a_{2n} \\ \dots & \dots & \dots & \dots \\ a_{n1} & a_{n2} & \dots & a_{nn} \end{vmatrix} = - \begin{vmatrix} a_{12} & a_{11} & \dots & a_{1n} \\ a_{22} & a_{21} & \dots & a_{2n} \\ \dots & \dots & \dots & \dots \\ a_{n1} & a_{n2} & \dots & a_{nn} \end{vmatrix}.$$

3. Ikkita bir xil satrli (yoki ustunli) determinant nolga teng.

4. Satrdagi (yoki ustundagi) barcha elementlarning umumiy ko'paytuvchisini determinant belgisidan tashqariga chiqarish mumkin:

$$\begin{vmatrix} \lambda a_{11} & \lambda a_{12} & \dots & \lambda a_{1n} \\ a_{21} & a_{22} & \dots & a_{2n} \\ \dots & \dots & \dots & \dots \\ a_{n1} & a_{n2} & \dots & a_{nn} \end{vmatrix} = \lambda \cdot \begin{vmatrix} a_{11} & a_{12} & \dots & a_{1n} \\ a_{21} & a_{22} & \dots & a_{2n} \\ \dots & \dots & \dots & \dots \\ a_{n1} & a_{n2} & \dots & a_{nn} \end{vmatrix}.$$

5. Agar biror satrning (yoki ustunning) barcha elementlari nolga teng bo'lsa, determinant nolga teng bo'ladi.

6. Agar determinantning biror satri (yoki ustuni) elementlariga boshqa satrning (boshqa ustunning) bir xil  $\lambda$  songa ko'paytirilgan mos elementlari qo'shilsa, determinant o'z qiymatini o'zgartirmaydi:

$$\begin{vmatrix} a_{11} & a_{12} & \dots & a_{1n} \\ a_{21} & a_{22} & \dots & a_{2n} \\ \dots & \dots & \dots & \dots \\ a_{n1} & a_{n2} & \dots & a_{nn} \end{vmatrix} = \begin{vmatrix} a_{11} + \lambda a_{1n} & a_{12} & \dots & a_{1n} \\ a_{21} + \lambda a_{2n} & a_{22} & \dots & a_{2n} \\ \dots & \dots & \dots & \dots \\ a_{n1} + \lambda a_{nn} & a_{n2} & \dots & a_{nn} \end{vmatrix}.$$

7. Determinantni o'zining ixtiyoriy  $i$ - satri elementlari bo'yicha yoyish mumkin:

$$D = a_{i1} A_{i1} + a_{i2} A_{i2} + \dots + a_{in} A_{in}.$$

2-misol.  $\begin{vmatrix} 5 & 20 & 5 & 15 \\ 2 & 4 & 4 & 8 \\ 1 & 4 & 3 & 7 \\ 0 & 0 & 9 & 0 \end{vmatrix}$  determinantni hisoblaymiz.

Yechish. To'rtinchi satrda noldan farqli bo'lgan bitta son turibdi. Shu sababli determinantni hisoblashda to'rtinchi satrdan va 7- xossadan foydalanamiz:

$$\begin{vmatrix} 5 & 20 & 5 & 15 \\ 2 & 4 & 4 & 8 \\ 1 & 4 & 3 & 7 \\ 0 & 0 & 9 & 0 \end{vmatrix} = 0 \cdot (-1)^{4+1} \begin{vmatrix} 20 & 5 & 15 \\ 4 & 4 & 8 \\ 4 & 3 & 7 \end{vmatrix} + 0 \cdot (-1)^{4+2} \begin{vmatrix} 5 & 5 & 15 \\ 2 & 4 & 8 \\ 1 & 3 & 7 \end{vmatrix} +$$

$$+9 \cdot (-1)^{4+3} \begin{vmatrix} 5 & 20 & 15 \\ 2 & 4 & 8 \\ 1 & 4 & 7 \end{vmatrix} + 0 \cdot (-1)^{4+4} \begin{vmatrix} 5 & 20 & 5 \\ 2 & 4 & 4 \\ 1 & 4 & 3 \end{vmatrix} =$$

$$= 0 + 0 + 9 \cdot (-1) \cdot (-80) + 0 = 720.$$

To'rtinchi tartibli determinant tushunchasi uchinchi tartibli determinant tushunchasi orqali aniqlandi. Xuddi shu kabi, beshinchi tartibli determinant tushunchasi to'rtinchi tartibli determinant orqali, oltinchi tartibli determinant esa beshinchi tartibli determinant orqali va umuman  $n$ - tartibli determinant ( $n-1$ )- tartibli determinant orqali aniqlanadi. Bunda elementning minori va algebraik to'ldiruvchisi tushunchalari xuddi  $n=4$  bo'lgan holdagidek ta'riflanadi.

3 - m i s o l . 
$$\begin{vmatrix} 5 & 20 & 5 & 15 & 1 \\ 2 & 4 & 4 & 8 & 3 \\ 1 & 4 & 3 & 7 & 2 \\ 0 & 0 & 9 & 0 & 1 \\ 0 & 0 & 0 & 0 & 2 \end{vmatrix}$$
 determinantni hisoblaymiz.

Y e c h i s h . Beshinchi satrda nollar va 2 soni turibdi. Shu sababli beshinchi tartibli determinantni hisoblashda aynan shu satrdan foydalanish qulaydir:

$$\begin{vmatrix} 5 & 20 & 5 & 15 & 1 \\ 2 & 4 & 4 & 8 & 3 \\ 1 & 4 & 3 & 7 & 2 \\ 0 & 0 & 9 & 0 & 1 \\ 0 & 0 & 0 & 0 & 2 \end{vmatrix} = 2 \cdot (-1)^{5+5} \cdot \begin{vmatrix} 5 & 20 & 5 & 15 \\ 2 & 4 & 4 & 8 \\ 1 & 4 & 3 & 7 \\ 0 & 0 & 9 & 0 \end{vmatrix} = 2 \cdot 720 = 1440.$$

4 - m i s o l . Quyidagi determinantni hisoblaymiz:

$$\Delta = \begin{vmatrix} -1 & -2 & 1 & 4 \\ 1 & 3 & 0 & 6 \\ 2 & -2 & 1 & 4 \\ 3 & 1 & -2 & -1 \end{vmatrix}.$$

Y e c h i s h . Birinchi satrga  $-1$  ga ko'paytirilgan uchinchi satrni qo'shamiz (6- xossa):

$$\Delta = \begin{vmatrix} -1+(-2) & -2+2 & 1+(-1) & 4+(-4) \\ 1 & 3 & 0 & 6 \\ 2 & -2 & 1 & 4 \\ 3 & 1 & -2 & -1 \end{vmatrix} = \begin{vmatrix} -3 & 0 & 0 & 0 \\ 1 & 3 & 0 & 6 \\ 2 & -2 & 1 & 4 \\ 3 & 1 & -2 & -1 \end{vmatrix}.$$

Oxirgi determinantning birinchi satrida uchta nol mavjud, shu sababli determinantni hisoblashda shu satrdan foydalanish ishni osonlashtiradi:

$$\Delta = (-3) \cdot (-1)^{1+1} \begin{vmatrix} 3 & 0 & 6 \\ -2 & 1 & 4 \\ 1 & -2 & -1 \end{vmatrix} = -3 \cdot 39 = -117.$$



## Mashqlar

**10.21.** Determinantni hisoblang:

$$1) \begin{vmatrix} 3 & 8 \\ 4 & 9 \end{vmatrix}; \quad 2) \begin{vmatrix} 1 & \sin \alpha \\ \sin \alpha & 1 \end{vmatrix}; \quad 3) \begin{vmatrix} 1 & 2 & 3 \\ 0 & 4 & 1 \\ 1 & 2 & 1 \end{vmatrix}; \quad 4) \begin{vmatrix} 1 & 1 & 1 \\ 2 & 4 & 6 \\ 3 & 5 & 8 \end{vmatrix}.$$

**10.22.**  $A = \begin{pmatrix} 1 & 4 & 9 \\ 0 & 3 & 2 \\ 0 & 4 & 5 \end{pmatrix}$  matritsa berilgan.  $|A|$ ,  $M_{12}$  va  $A_{12}$  ni toping.

**10.23.** Determinantni hisoblang:

$$1) \begin{vmatrix} 2 & -1 & 3 & -1 \\ 0 & 1 & -2 & 4 \\ 0 & 2 & -1 & 3 \\ 0 & -2 & 0 & 0 \end{vmatrix}; \quad 2) \begin{vmatrix} 1 & 2 & 3 & 4 \\ 0 & 2 & 3 & 4 \\ 1 & 2 & 1 & 3 \\ 3 & 3 & 4 & 1 \end{vmatrix};$$

$$3) \begin{vmatrix} 3 & 1 & 1 & 1 \\ 1 & 3 & 1 & 1 \\ 1 & 1 & 3 & 1 \\ 1 & 1 & 1 & 3 \end{vmatrix}; \quad 4) \begin{vmatrix} 1 & 1 & 1 & 1 \\ 1 & 2 & 3 & 4 \\ 1 & 3 & 6 & 10 \\ 1 & 4 & 10 & 20 \end{vmatrix};$$

$$5) \begin{vmatrix} 3 & 4 & 5 & 6 & 7 \\ 0 & 2 & -1 & 3 & -1 \\ 0 & 0 & 1 & -2 & 4 \\ 0 & 0 & 2 & -1 & 3 \\ 0 & 0 & -2 & 0 & 0 \end{vmatrix}; \quad 6) \begin{vmatrix} 0 & 1 & 2 & 3 & 4 \\ 0 & 0 & 2 & 3 & 4 \\ 0 & 1 & 2 & 1 & 3 \\ 0 & 3 & 3 & 4 & 1 \\ 2 & 4 & 8 & 9 & 10 \end{vmatrix}.$$

**10.24.**  $A = \begin{pmatrix} 1 & 2 & 3 & 4 \\ 5 & 6 & 7 & 0 \\ 0 & 0 & 1 & 1 \\ 1 & 0 & 0 & 0 \end{pmatrix}$  matritsa berilgan. Uning birinchi

satridan foydalanib,  $\det A$  ni hisoblang.

**10.25.**  $\det(AB) = \det A \cdot \det B$  tenglik o'rinli ekanligiga  $A = \begin{pmatrix} 1 & 2 & 3 \\ 0 & 5 & 0 \\ 7 & 0 & 9 \end{pmatrix}$

va  $B = \begin{pmatrix} 1 & 3 & 0 \\ 0 & 0 & 3 \\ 1 & 2 & 3 \end{pmatrix}$  matritsalar misolida ishonch hosil qiling.

**10.26.**  $\begin{vmatrix} am + bp & an + bq \\ cm + dp & cn + dq \end{vmatrix}$  determinantni qo'shiluvchilarga yoyish bilan soddalashtiring.

### 3. Teskari matritsa. $n$ -tartibli kvadrat matritsa

$$\begin{pmatrix} a_{11} & a_{12} & \dots & a_{1n} \\ a_{21} & a_{22} & \dots & a_{2n} \\ \dots & \dots & \dots & \dots \\ a_{n1} & a_{n2} & \dots & a_{nn} \end{pmatrix}$$

ning bosh diagonali  $a_{11}, a_{22}, \dots, a_{nn}$  dagi barcha elementlar 1 ga, qolgan elementlar esa 0 ga teng bo'lsa, bu matritsa *birlik matritsa* deyiladi va  $E$  harfi bilan belgilanadi. Ushbu

$$E = \begin{pmatrix} 1 & 0 \\ 0 & 1 \end{pmatrix} \text{ va } E = \begin{pmatrix} 1 & 0 & 0 \\ 0 & 1 & 0 \\ 0 & 0 & 1 \end{pmatrix}$$

matritsalar mos ravishda ikkinchi va uchinchi tartibli birlik matritsalaridir.

Birlik matritsa alohida ahamiyatga ega: istalgan  $n$ - tartibli  $A$  kvadrat matritsani  $n$  tartibli  $E$  birlik matritsaga ko'paytirish natijasida  $A$  matritsaning o'zi hosil bo'ladi, ya'ni  $AE = A$ .

Agar  $n$ -tartibli  $A$  va  $B$  kvadrat matritsalar uchun  $AB = E$  tenglik o'rinli bo'lsa,  $B$  matritsa  $A$  matritsaga *teskari matritsa* deyiladi.

Agar  $B$  matritsa  $A$  matritsaga teskari matritsa bo'lsa,  $A$  matritsa  $B$  matritsaga teskari matritsa bo'lishini, ya'ni  $BA = E$  tenglik ham bajarilishini isbotlash mumkin.

$A$  matritsaga teskari matritsani  $A^{-1}$  bilan belgilash qabul qilingan.

$$A = \begin{pmatrix} 7 & 2 \\ 3 & 1 \end{pmatrix} \text{ matritsa uchun } A^{-1} = \begin{pmatrix} 1 & -2 \\ -3 & 7 \end{pmatrix} \text{ matritsa teskari}$$

matritsadir (qarang, 1-band, 6-misol).

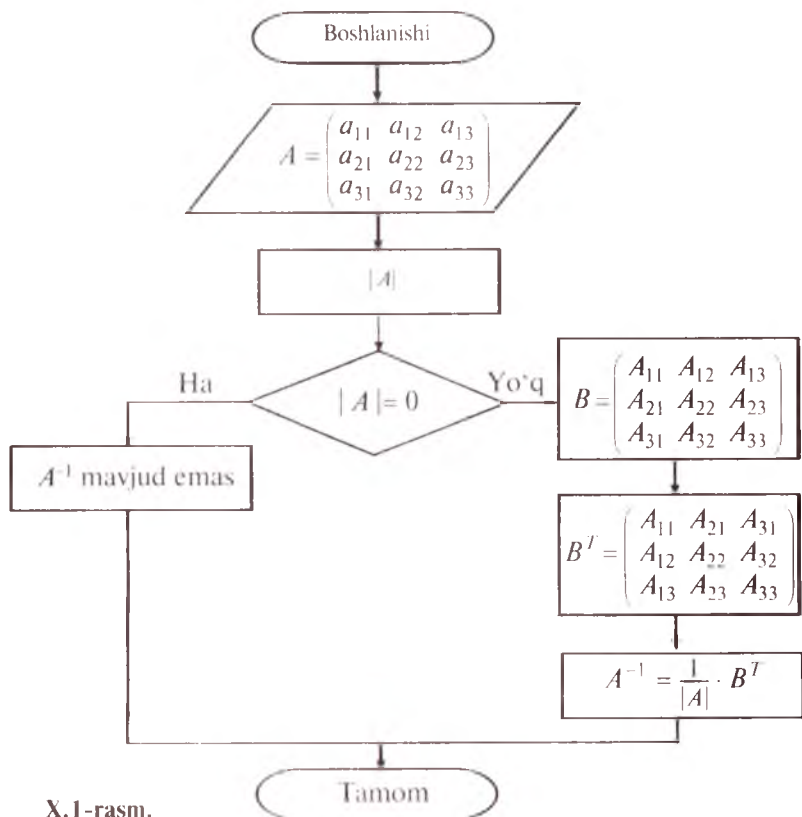

X.1-rasm.

Berilgan kvadrat matritsaga teskari matritsani topish algoritmini quyidagi sxema ko'rinishida ifodalaymiz (misol sifatida, uchinchi tartibli kvadrat matritsani qaraymiz, X.1-rasmga qarang).

1 - misol.  $A = \begin{pmatrix} 1 & 1 & -1 \\ 2 & 1 & 0 \\ 1 & -1 & 1 \end{pmatrix}$  matritsaga teskari matritsani topamiz.

**Y e c h i s h .** Berilgan matritsaning determinantini topamiz:

$$|A| = \begin{vmatrix} 1 & 1 & -1 \\ 2 & 1 & 0 \\ 1 & -1 & 1 \end{vmatrix} = 1 + 2 + 1 - 2 = 2.$$

$|A| = 2$  bo'lganidan  $A$  matritsaga  $A^{-1}$  teskari matritsa mavjud. Uni tuzish maqsadida  $A$  matritsa elementlarining algebraik to'ldiruvchilarini topamiz:

$$A_{11} = (-1)^{1+1} \cdot \begin{vmatrix} 1 & 0 \\ -1 & 1 \end{vmatrix} = 1;$$

$$A_{21} = (-1)^{2+1} \cdot \begin{vmatrix} 1 & -1 \\ -1 & 1 \end{vmatrix} = 0;$$

$$A_{31} = (-1)^{3+1} \cdot \begin{vmatrix} 1 & -1 \\ 1 & 0 \end{vmatrix} = 1;$$

$$A_{12} = (-1)^{1+2} \cdot \begin{vmatrix} 2 & 0 \\ 1 & 1 \end{vmatrix} = -2;$$

$$A_{22} = (-1)^{2+2} \cdot \begin{vmatrix} 1 & -1 \\ 1 & 1 \end{vmatrix} = 2;$$

$$A_{32} = (-1)^{3+2} \cdot \begin{vmatrix} 1 & -1 \\ 2 & 0 \end{vmatrix} = -2;$$

$$A_{13} = (-1)^{1+3} \cdot \begin{vmatrix} 2 & 1 \\ 1 & -1 \end{vmatrix} = -3;$$

$$A_{23} = (-1)^{2+3} \cdot \begin{vmatrix} 1 & 1 \\ 1 & -1 \end{vmatrix} = -2;$$

$$A_{33} = (-1)^{3+3} \cdot \begin{vmatrix} 1 & 1 \\ 2 & 1 \end{vmatrix} = -1.$$

Endi  $A$  matritsada gi har bir elementni uning algebraik to'ldi-

ruvchisi bilan almashtirishdan hosil bo'ladigan  $B = \begin{pmatrix} 1 & -2 & -3 \\ 0 & 2 & -2 \\ 1 & -2 & -1 \end{pmatrix}$

matritsani tuzamiz va uni transponirlaymiz:  $B^T = \begin{pmatrix} 1 & 0 & 1 \\ -2 & 2 & -2 \\ -3 & -2 & -1 \end{pmatrix}$ .

$$\text{U holda, } A^{-1} = \frac{1}{|A|} \cdot B^T = \frac{1}{2} \cdot \begin{pmatrix} 1 & 0 & 1 \\ -2 & 2 & -2 \\ -3 & -2 & -1 \end{pmatrix} = \begin{pmatrix} \frac{1}{2} & 0 & \frac{1}{2} \\ -1 & 1 & -1 \\ -\frac{3}{2} & -1 & -\frac{1}{2} \end{pmatrix}.$$

2 - misol.  $A = \begin{pmatrix} 1 & 2 \\ 2 & 4 \end{pmatrix}$  matritsaga teskari matritsani topamiz.

Yechish.  $|A| = \begin{vmatrix} 1 & 2 \\ 2 & 4 \end{vmatrix} = 4 - 4 = 0$  bo'lgani uchun berilgan matritsaga teskari matritsa mavjud emas.



### Mashqlar

**10.27.** Agar  $A = \begin{pmatrix} a & b \\ c & d \end{pmatrix}$  matritsa uchun  $|A| = ad - bc \neq 0$  bo'lsa,

u holda  $A^{-1} = \frac{1}{|A|} \begin{pmatrix} d & -b \\ -c & a \end{pmatrix}$  bo'lishiga ishonch hosil qiling.



10.28.  $\begin{pmatrix} 1 & 2 & 3 \\ 2 & 4 & 6 \\ 1 & 3 & 5 \end{pmatrix}$  matritsaga teskari matritsa mavjudmi?

10.29. Matritsaga teskari matritsani toping:

1)  $\begin{pmatrix} 1 & 3 \\ 4 & 7 \end{pmatrix}$ ;      2)  $\begin{pmatrix} 2 & 6 \\ 3 & 4 \end{pmatrix}$ ;      3)  $\begin{pmatrix} 3 & 4 & 1 \\ 2 & 3 & 1 \\ 5 & 2 & 2 \end{pmatrix}$ ;

4)  $\begin{pmatrix} 1 & 2 & -3 \\ 0 & 1 & 2 \\ 0 & 0 & 1 \end{pmatrix}$ ;      5)  $\begin{pmatrix} 1 & 3 & -5 & 7 \\ 0 & 1 & 2 & -3 \\ 0 & 0 & 1 & 2 \\ 0 & 0 & 0 & 1 \end{pmatrix}$ ;      6)  $\begin{pmatrix} 1 & 1 & 1 & 1 \\ 1 & 1 & -1 & -1 \\ 1 & -1 & 1 & -1 \\ 1 & -1 & -1 & 1 \end{pmatrix}$ .

10.30. Matritsaviy tenglamadan  $X$  matritsani toping ( $AB \neq BA$ ):

1)  $\begin{pmatrix} 2 & 5 \\ 1 & 3 \end{pmatrix} X = \begin{pmatrix} 4 & -6 \\ 2 & 1 \end{pmatrix}$ ;      2)  $X \begin{pmatrix} 2 & 3 \\ 5 & 8 \end{pmatrix} = \begin{pmatrix} -3 & 2 \\ 1 & 4 \end{pmatrix}$ ;

3)  $\begin{pmatrix} 3 & 4 & 1 \\ 2 & 3 & 1 \\ 5 & 2 & 2 \end{pmatrix} X = \begin{pmatrix} 1 & 2 & 3 \\ -1 & 0 & 1 \\ 0 & 0 & 2 \end{pmatrix}$ ;      4)  $X \begin{pmatrix} 1 & 2 & -3 \\ 0 & 1 & 2 \\ 0 & 0 & 1 \end{pmatrix} = \begin{pmatrix} 3 & 4 & 1 \\ 2 & 3 & 1 \\ 5 & 2 & 2 \end{pmatrix}$ .

10.31.  $A = \begin{pmatrix} 1 & 1 \\ 0 & 1 \end{pmatrix}$  va  $B = \begin{pmatrix} 1 & 0 \\ 2 & 1 \end{pmatrix}$  matritsalar uchun  $(AB)^{-1} = A^{-1} \cdot B^{-1}$  bo'lishini isbotlang.

4.  $n$  noma'lumli  $n$  ta chiziqli tenglamalar sistemasini matritsalar yordamida yechish.

$$A = \begin{pmatrix} a_{11} & a_{12} & \dots & a_{1n} \\ a_{21} & a_{22} & \dots & a_{2n} \\ \dots & \dots & \dots & \dots \\ a_{n1} & a_{n2} & \dots & a_{nn} \end{pmatrix}, \quad X = \begin{pmatrix} x_1 \\ x_2 \\ \dots \\ x_n \end{pmatrix}, \quad C = \begin{pmatrix} c_1 \\ c_2 \\ \dots \\ c_n \end{pmatrix}$$

matritsalarini qaraymiz. Matritsalarini ko'paytirish qoidasiga ko'ra,

$$AX = \begin{pmatrix} a_{11} & a_{12} & \dots & a_{1n} \\ a_{21} & a_{22} & \dots & a_{2n} \\ \dots & \dots & \dots & \dots \\ a_{n1} & a_{n2} & \dots & a_{nn} \end{pmatrix} \cdot \begin{pmatrix} x_1 \\ x_2 \\ \dots \\ x_n \end{pmatrix} = \begin{pmatrix} a_{11}x_1 + a_{12}x_2 + \dots + a_{1n}x_n \\ a_{21}x_1 + a_{22}x_2 + \dots + a_{2n}x_n \\ \dots \\ a_{n1}x_1 + a_{n2}x_2 + \dots + a_{nn}x_n \end{pmatrix}$$

matritsaviy tenglik o'rinlidir. Bu yerdan,  $n$  noma'lumli  $n$  ta

$$\begin{cases} a_{11}x_1 + a_{12}x_2 + \dots + a_{1n}x_n = c_1 \\ a_{21}x_1 + a_{22}x_2 + \dots + a_{2n}x_n = c_2 \\ \dots \\ a_{n1}x_1 + a_{n2}x_2 + \dots + a_{nn}x_n = c_n \end{cases} \quad (1)$$

chiziqli tenglama sistemasini yuqoridagi  $A$ ,  $X$ ,  $C$  matritsalar yordamida

$$AX = C \quad (2)$$

ko'rinishda yozish mumkinligini ko'ramiz.

(2) tenglama (1) tenglamalar sistemasining *matritsaviy yozuvi* deyiladi. Agar  $|A| = 0$  bo'lsa, (1) tenglamalar sistemasini matritsaviy usulda yechib bo'lmaydi.

$|A| \neq 0$  bo'lsin. U holda  $A^{-1}$  matritsa mavjuddir. (2) tenglamaning har ikki tomonini  $A^{-1}$  ga ko'paytirib,

$$A^{-1}(AX) = A^{-1}C \text{ yoki } (A^{-1}A)X = A^{-1}C$$

ni olamiz.  $A^{-1}A = E$  va  $EX = X$  bo'lgani uchun matritsaviy tenglamaning yechimini quyidagi ko'rinishda hosil qilamiz:

$$X = A^{-1}C. \quad (3)$$

Bu esa chiziqli tenglamalar sistemasini yechishning yana bir usulidir. Shu usulning tatbiqiga doir misol qaraymiz.

Misol. 
$$\begin{cases} 7x + 2y + 3z = 13, \\ 9x + 3y + 4z = 15, \\ 5x + y + 3z = 14 \end{cases}$$
 tenglamalar sistemasini yechamiz.

**Yechish.** Berilgan sistemani matritsaviy shaklda yozib olamiz:

$$\begin{pmatrix} 7 & 2 & 3 \\ 9 & 3 & 4 \\ 5 & 1 & 3 \end{pmatrix} \begin{pmatrix} x \\ y \\ z \end{pmatrix} = \begin{pmatrix} 13 \\ 15 \\ 14 \end{pmatrix}.$$

$A = \begin{pmatrix} 7 & 2 & 3 \\ 9 & 3 & 4 \\ 5 & 1 & 3 \end{pmatrix}$  matritsaning determinanti  $|A| = \frac{1}{3} \neq 0$  bo'lgani

uchun  $A^{-1}$  matritsa mavjud. Uni tuzamiz:

$$A^{-1} = \begin{pmatrix} \frac{5}{3} & -1 & -\frac{1}{3} \\ -\frac{7}{3} & 2 & -\frac{1}{3} \\ -2 & 1 & 1 \end{pmatrix}.$$

U holda (3) tenglikka ko'ra

$$\begin{pmatrix} x \\ y \\ z \end{pmatrix} = \begin{pmatrix} \frac{5}{3} & -1 & -\frac{1}{3} \\ -\frac{7}{3} & 2 & -\frac{1}{3} \\ -2 & 1 & 1 \end{pmatrix} \begin{pmatrix} 13 \\ 15 \\ 14 \end{pmatrix} = \begin{pmatrix} 2 \\ -5 \\ 3 \end{pmatrix}$$

tenglikni olamiz. Demak,  $x = 2$ ,  $y = -5$ ,  $z = 3$ .



## Mashqlar

10.32. Tenglamalar sistemasini matritsaviy usulda yeching:

$$1) \begin{cases} 3x_1 - x_2 = 5, \\ -2x_1 + x_2 + x_3 = 0, \\ 2x_1 - x_2 + 4x_3 = 15; \end{cases} \quad 2) \begin{cases} 5x + 4y + 3z = 0, \\ x + y - z = 0, \\ x + 3y - z = 0; \end{cases}$$

$$3) \begin{cases} 2x_1 - x_2 - x_3 = 4, \\ 3x_1 + 4x_2 - 2x_3 = 11, \\ 3x_1 - 2x_2 + 4x_3 = 15; \end{cases} \quad 4) \begin{cases} 4x + 5y - z = 0, \\ x - 3y + 2z = 0, \\ 2x - 9y + 3z = 0; \end{cases}$$

$$5) \begin{cases} 2x - 3y + z = 7, \\ x + y - z = 2, \\ x + 2y - 3z = -1; \end{cases} \quad 6) \begin{cases} 4x_1 - 3x_2 + x_3 = 0, \\ 5x_1 - x_2 + x_3 = 0, \\ x_1 + 2x_2 - 3x_3 = 0; \end{cases}$$

$$7) \begin{cases} 2x_1 + x_2 - 5x_3 + x_4 = 8, \\ x_1 - 3x_2 - 6x_4 = 9, \\ 2x_2 - x_3 + 4x_4 = -5, \\ x_1 + 4x_2 - 7x_3 + 6x_4 = 0; \end{cases} \quad 8) \begin{cases} x_1 + x_2 + x_3 + x_4 = 0, \\ x_1 + 2x_2 + 3x_3 + 4x_4 = 0, \\ x_1 + 3x_2 + 6x_3 + 10x_4 = 0, \\ x_1 + 4x_2 + 10x_3 + 20x_4 = 0; \end{cases}$$

$$9) \begin{cases} x_1 + x_2 + x_3 + x_4 + x_5 = 0, \\ x_1 - x_2 + 2x_3 - 2x_4 + 3x_5 = 0, \\ x_1 + x_2 + 4x_3 + 4x_4 + 9x_5 = 0, \\ x_1 - x_2 + 8x_3 - 8x_4 + 27x_5 = 0, \\ x_1 + x_2 + 16x_3 + 16x_4 + 81x_5 = 0; \end{cases}$$

$$10) \begin{cases} x_1 + 2x_2 - 3x_3 + 4x_4 - x_5 = -1, \\ 2x_1 - x_2 + 3x_3 - 4x_4 + 25x_5 = 8, \\ 3x_1 + x_2 - x_3 + 2x_4 - x_5 = 3, \\ 4x_1 + 3x_2 + 4x_3 + 2x_4 + 2x_5 = -2, \\ x_1 - x_2 - x_3 + 2x_4 - 3x_5 = -3. \end{cases}$$

### 2-§. Chiziqli fazo

**1. Chiziqli fazo tushunchasi.** Matematika, fizika, mexanikada shunday obyektlar uchraydiki, ular bir yoki bir nechta haqiqiy sonlarning tartiblangan sistemasi bilan aniqlanadi. Masalan, tekislikdagi har qanday nuqta o'zining ikkita koordinatasi bilan,

har qanday vektor o'zining ikkita tashkil etuvchisi (koordinatalari) bilan aniqlanadi. Agar vektor fazoda berilgan bo'lsa, u o'zining uchta tashkil etuvchisi (koordinatalari) bilan xarakterlanadi.

Tekislikdagi vektorlarning eng sodda umumlashmasi *n o'lchovli* vektordir.

Tartib bilan yozilgan *n* ta haqiqiy sonlar sistemasi, ya'ni  $a = (a_1, a_2, \dots, a_n)$  *n o'lchovli vektor* deyiladi. Bu yerda  $a_1, a_2, \dots, a_n$  sonlar *vektorning koordinatalari* deyiladi.

Tekislikdagi barcha vektor (yo'naltirilgan kesma)lar to'plamini  $V^2$  bilan va  $m \times n$  o'lchamli barcha matritsalar to'plamini  $R_{m \times n}$  bilan belgilaymiz. Bu to'plamlarning har birida elementlarni qo'shish va elementni haqiqiy songa ko'paytirish amallari kiritilgandir.

Elementlarni qo'shish va elementni haqiqiy songa ko'paytirish amallarining  $V^2$  to'plamdagi bajarilishi shu amallarning  $R_{m \times n}$  to'plamdagi bajarilishiga mutlaqo o'xshamasa-da, bu amallarning umumiy xossalari mavjud:

Tartib raqami	$V^2$ to'plamda	$R_{m \times n}$ to'plamda
1	$\forall \bar{a}, \bar{b} \in V^2$ vektorlar uchun $\bar{a} + \bar{b} = \bar{b} + \bar{a}$	$\forall A, B \in R_{m \times n}$ matritsalar uchun $A + B = B + A$
2	$\forall \bar{a}, \bar{b}, \bar{c} \in V^2$ vektorlar uchun $(\bar{a} + \bar{b}) + \bar{c} = \bar{a} + (\bar{b} + \bar{c})$	$\forall A, B, C \in R_{m \times n}$ matritsalar uchun $(A + B) + C = A + (B + C)$
3	$\forall \bar{a} \in V^2$ vektor uchun $\bar{a} + \bar{0} = \bar{a}$ (bu yerda $\bar{0}$ – nol-vektor)	$\forall A \in R_{m \times n}$ matritsa uchun $A + O = A$ (bu yerda $O = \begin{pmatrix} 0 & 0 & 0 & \dots & 0 \\ 0 & 0 & 0 & \dots & 0 \\ \dots & \dots & \dots & \dots & \dots \\ 0 & 0 & 0 & \dots & 0 \end{pmatrix} \in R_{m \times n}$ )

4	$\forall \bar{a} \in V^2$ vektor uchun unga qarama-qarshi $-\bar{a}$ vektor mavjud:	$\forall A \in R_{m \times n}$ matritsa uchun unga qarama-qarshi $-A$ matritsa mavjud: $A + (-A) = O = \begin{pmatrix} 0 & 0 & 0 & \dots & 0 \\ 0 & 0 & 0 & \dots & 0 \\ \dots & \dots & \dots & \dots & \dots \\ 0 & 0 & 0 & \dots & 0 \end{pmatrix}$
5	$\forall \bar{a} \in V^2$ vektor uchun $1 \cdot \bar{a} = \bar{a}$ ( $1 \in R$ )	$\forall A \in R_{m \times n}$ matritsa uchun $1 \cdot A = A$ ( $1 \in R$ )
6	$\forall \bar{a} \in V^2$ vektor va $\forall \alpha, \beta \in R$ sonlar uchun $\alpha(\beta\bar{a}) = (\alpha\beta)\bar{a}$	$\forall A \in R_{m \times n}$ matritsa va $\forall \alpha, \beta \in R$ sonlari uchun $\alpha(\beta A) = (\alpha\beta)A$
7	$\forall \bar{a} \in V^2$ vektor va $\forall \alpha, \beta \in R$ sonlar uchun $(\alpha + \beta)\bar{a} = \alpha\bar{a} + \beta\bar{a}$	$\forall A \in R_{m \times n}$ matritsa va $\forall \alpha, \beta \in R$ sonlari uchun $(\alpha + \beta)A = \alpha A + \beta A$
8	$\forall \bar{a}, \bar{b} \in V^2$ vektorlar va $\forall \alpha \in R$ son uchun $\alpha(\bar{a} + \bar{b}) = \alpha\bar{a} + \alpha\bar{b}$	$\forall A, B \in R_{m \times n}$ matritsa va $\forall \alpha \in R$ sonlari uchun $\alpha(A + B) = \alpha A + \alpha B$

Elementlarni qo'shish va elementlarni songa ko'paytirish amallari xossalaridagi bu umumiylik tabiatan bir-biriga o'xshamaydigan to'plamlarni umumiy nuqtayi nazardan o'rganish imkonini beradi va chiziqli fazo tushunchasiga olib keladi.

Bo'sh bo'lmagan  $L$  to'plam berilgan bo'lsin va bu to'plamda elementlarni qo'shish va elementni haqiqiy songa ko'paytirish amallari kiritilgan bo'lsin. Agar  $\forall x, y, z \in L; \alpha, \beta \in R$  uchun quyidagi 8 ta xossa o'rinli bo'lsa, bu amallarni *chiziqli amallar* deb ataymiz:

1.  $x + y = y + x$ .

2.  $(x + y) + z = x + (y + z)$ .

3.  $L$  to'plamda shunday bir  $\theta$  element mavjudki, ixtiyoriy  $x \in L$  element uchun  $x + \theta = x$  tenglik o'rinli bo'ladi.  $\theta$  elementni nol-element deb ataymiz.

4. Ixtiyoriy  $x \in L$  element uchun  $x + (-x) = \theta$  tenglik o'rinli bo'ladigan  $-x \in L$  element ( $x$  ga qarama-qarshi element) mavjud.

$$5. 1 \cdot x = x.$$

$$6. \alpha(\beta x) = (\alpha\beta)x.$$

$$7. (\alpha + \beta)x = \alpha x + \beta x.$$

$$8. \alpha(x - y) = \alpha x - \alpha y.$$

Chiziqli amallar kiritilgan  $L$  to'plam *chiziqli fazo* (yoki *vektor fazo*), uning elementlari esa *vektorlar* deb ataladi. Chiziqli fazo odatdagi uch o'lchovli fazoning umumlashmasidan iborat ekan.

$R_{m \times n}$  va  $V^2$  to'plamlarning har biri chiziqli fazodir. Chiziqli fazoga doir boshqa misol qarashdan oldin, har qanday  $L$  chiziqli fazoda o'rinli bo'ladigan quyidagi xossalarni keltiramiz:

$$1. 0 \cdot x = \theta.$$

$$2. -x = (-1) \cdot x.$$

$$3. x - y = x + (-y).$$

$$4. (\alpha - \beta)x = \alpha x - \beta x.$$

$$5. \alpha(x - y) = \alpha x - \alpha y.$$

$$6. \alpha \cdot \theta = \theta.$$

$$7. \alpha \cdot x = \theta \text{ bo'lsa, } \alpha = 0 \text{ yoki } x = \theta \text{ bo'ladi.}$$

Bu xossalarning o'rinli ekanligi *chiziqli fazo aksiomalari* (1–8-xossalar) dan kelib chiqadi.

**Misol.** ( $n$  o'lchovli arifmetik fazo.)  $a = (a_1, a_2, \dots, a_n)$  vektor berilgan bo'lsin. Barcha  $n$  o'lchovli vektorlar to'plamini  $R^n$  bilan belgilaymiz. Bu to'plamdagi ikkita element ularning mos koordinatalari teng bo'lgandagina teng deb hisoblanadi:

$$a = b \Leftrightarrow a_i = b_i \quad (i = 1, 2, \dots, n, a \in R^n, b \in R^n).$$

$R^n$  to'plamda elementlarni qo'shish va elementni songa ko'paytirish amallari quyidagicha aniqlanadi:

$$a + b = (a_1 + b_1; a_2 + b_2; \dots; a_n + b_n);$$

$$\lambda a = (\lambda a_1; \lambda a_2; \dots; \lambda a_n).$$

$R^n$  to'plamning chiziqli fazo bo'lishligini, ya'ni kiritilgan bu amallarning chiziqli amallar ekanligini ko'rsatamiz.  $a \in R^n, b \in R^n, c \in R^n, \alpha \in R, \beta \in R$  bo'lsin. U holda:

$$1. a + b = (a_1 + b_1; a_2 + b_2; \dots; a_n + b_n) = (b_1 + a_1; b_2 + a_2; \dots; b_n + a_n) = b + a.$$

$$\begin{aligned} 2. (a + b) + c &= (a_1 + b_1; a_2 + b_2; \dots; a_n + b_n) + (c_1; c_2; \dots; c_n) = \\ &= (a_1 + b_1 + c_1; a_2 + b_2 + c_2; \dots; a_n + b_n + c_n) = \\ &= (a_1 + (b_1 + c_1); a_2 + (b_2 + c_2); \dots; a_n + (b_n + c_n)) = \end{aligned}$$

$$= (a_1; a_2; \dots; a_n) + (b_1 + c_1; b_2 + c_2; \dots; b_n + c_n) = a + (b + c).$$

3.  $\theta = \underbrace{0, 0, \dots, 0}_{n \text{ ta}}$  elementni qaraymiz. Ixtiyoriy  $a \in R^n$  element uchun

$$a + \theta = (a_1 + 0; a_2 + 0; \dots; a_n + 0) = (a_1; a_2; \dots; a_n) = a$$

tenglik o'rinli.

4.  $a \in R^n$  bo'lsin.  $-a = (-1) \cdot a = (-a_1; -a_2; \dots; -a_n)$  elementni qaraymiz.

$$a + (-a) = (a_1 + (-a_1); a_2 + (-a_2); \dots; a_n + (-a_n)) = \underbrace{(0, 0, \dots, 0)}_{n \text{ ta}} = \theta$$

tenglik o'rinli.

$$5. 1 \cdot a = (1 \cdot a_1; 1 \cdot a_2; \dots; 1 \cdot a_n) = (a_1; a_2; \dots; a_n) = a.$$

$$6. \alpha \cdot (\beta \cdot a) = \alpha \cdot (\beta \cdot a_1; \beta \cdot a_2; \dots; \beta \cdot a_n) = (\alpha \cdot \beta \cdot a_1; \alpha \cdot \beta \cdot a_2; \dots; \alpha \cdot \beta \cdot a_n) = ((\alpha \cdot \beta) a_1; (\alpha \cdot \beta) a_2; \dots; (\alpha \cdot \beta) a_n) = (\alpha \cdot \beta) \cdot (a_1; a_2; \dots; a_n).$$

$$7. (\alpha + \beta)a = ((\alpha + \beta)a_1; (\alpha + \beta)a_2; \dots; (\alpha + \beta)a_n) = (\alpha a_1 + \beta a_1; \alpha a_2 + \beta a_2; \dots; \alpha a_n + \beta a_n) = (\alpha a_1; \alpha a_2; \dots; \alpha a_n) + (\beta a_1; \beta a_2; \dots; \beta a_n) = \alpha a + \beta a.$$

$$8. \alpha(a + b) = \alpha(a_1 + b_1; a_2 + b_2; \dots; a_n + b_n) = (\alpha(a_1 + b_1); \alpha(a_2 + b_2); \dots; \alpha(a_n + b_n)) = (\alpha a_1 + \alpha b_1; \alpha a_2 + \alpha b_2; \dots; \alpha a_n + \alpha b_n) = (\alpha a_1; \alpha a_2; \dots; \alpha a_n) + (\alpha b_1; \alpha b_2; \dots; \alpha b_n) = \alpha a + \alpha b.$$

Demak,  $R^n$  to'plam chiziqli fazo ekan. Bu chiziqli fazo *n* o'lchovli arifmetik fazo deb yuritiladi.

**T e o r e m a .** Chiziqli fazo bo'ladigan to'plamlar cheksiz ko'pdir.

**I s b o t .** Ixtiyoriy  $n$  natural son uchun  $R^n$  to'plam chiziqli fazodir. Natural sonlar cheksiz ko'p bo'lganligi uchun chiziqli fazo bo'ladigan cheksiz ko'p to'plamlar mavjuddir.



## Mashqlar

**10.33.** Quyidagi to'plam chiziqli fazo bo'ladimi:

1) Bo'sh to'plam; 2)  $\{1\}$ ?

**10.34.** Barcha haqiqiy sonlar to'plami chiziqli fazo tashkil etishini isbotlang.

**10.35.**  $L = \{0\}$  to'plamning chiziqli fazo tashkil etishini isbotlang.

**10.36.** Darajasi  $n$  natural sondan oshmaydigan hamda qo'shish va ko'paytirish amallari odatdagicha bajariladigan barcha ko'phadlar to'plamining chiziqli fazo bo'lishini isbotlang.

**10.37.**  $R$  da aniqlangan barcha funksiyalar  $L = \{f(x)\}$  to'plami funksiyalarni qo'shish va songa ko'paytirishning odatdagi aniqlanishiga ko'ra chiziqli fazo hosil qilishini isbotlang.

**10.38.**  $L = \{a \cdot e^x + b \cdot e^{-x} | x \in R\}$  to'plam chiziqli fazo tashkil etishini isbotlang.

**10.39.**  $[0; 1]$  kesmada uzluksiz bo'lgan barcha  $f(x)$  funksiyalar to'plami funksiyalarni qo'shish va songa ko'paytirishning odatdagi aniqlanishiga ko'ra chiziqli fazo tashkil etishini isbotlang.

**10.40.** Darajasi  $n$  ga teng bo'lgan barcha ko'phadlar to'plami chiziqli fazo tashkil etmasligini isbotlang.

**2. Chiziqli erkli va chiziqli bog'liq vektorlar.**  $L$  chiziqli fazoning  $x_1, x_2, \dots, x_k$  vektorlarini qaraymiz. Ushbu

$$\alpha_1 x_1 + \alpha_2 x_2 + \dots + \alpha_k x_k \quad (1)$$

ifoda  $x_1, x_2, \dots, x_k$  vektorlarning koeffitsiyentlari  $\alpha_1, \alpha_2, \dots, \alpha_k$  bo'lgan *chiziqli kombinatsiyasi* deyiladi (bu yerda  $\alpha_1, \alpha_2, \dots, \alpha_k$  — haqiqiy sonlar).

$x_1, x_2, \dots, x_k$  vektorlarning har qanday chiziqli kombinatsiyasi  $L$  to'plamning elementi bo'ladi, chunki elementlar ustida chiziqli amallar bajarish natijasida shu chiziqli fazoga tegishli bo'lgan element hosil bo'ladi.

1-misol.  $R^4$  fazodagi  $x_1 = (1; 0; 0; 0)$ ,  $x_2 = (0; 1; 0; 0)$ ,  $x_3 = (0; 0; 1; 0)$ ,  $x_4 = (0; 0; 0; 1)$  vektorlarning koeffitsiyentlari  $\alpha_1, \alpha_2, \alpha_3, \alpha_4$  bo'lgan chiziqli kombinatsiyasi  $R^4$  fazoning qanday vektoriga teng bo'lishini aniqlaymiz.

**Yechish.**

$$\begin{aligned} \alpha_1 x_1 + \alpha_2 x_2 + \alpha_3 x_3 + \alpha_4 x_4 &= \alpha_1 (1; 0; 0; 0) + \alpha_2 (0; 1; 0; 0) + \\ &+ \alpha_3 (0; 0; 1; 0) + \alpha_4 (0; 0; 0; 1) = (\alpha_1; 0; 0; 0) + (0; \alpha_2; 0; 0) + \\ &+ (0; 0; \alpha_3; 0) + (0; 0; 0; \alpha_4) = (\alpha_1; \alpha_2; \alpha_3; \alpha_4). \end{aligned}$$

Shunday qilib,  $x_1 = (1; 0; 0; 0)$ ,  $x_2 = (0; 1; 0; 0)$ ,  $x_3 = (0; 0; 1; 0)$ ,  $x_4 = (0; 0; 0; 1)$  vektorlarning koeffitsiyentlari  $\alpha_1, \alpha_2, \alpha_3, \alpha_4$  bo'lgan chiziqli kombinatsiyasi koordinatalari  $\alpha_1, \alpha_2, \alpha_3, \alpha_4$  bo'lgan to'rt o'lchovli  $(\alpha_1, \alpha_2, \alpha_3, \alpha_4)$  vektorga teng ekan.

Agar  $y \in L$  vektor  $L$  chiziqli fazodagi  $x_1, x_2, \dots, x_k$  vektorlarning chiziqli kombinatsiyasi ko'rinishda, ya'ni

$$y = \alpha_1 x_1 + \alpha_2 x_2 + \dots + \alpha_k x_k \quad (2)$$



ko'rinishda tasvirlangan bo'lsa,  $y$  vektor  $x_1, x_2, \dots, x_k$  vektorlar bo'yicha yoyilgan deyiladi.

1-misolda  $(\alpha_1; \alpha_2; \alpha_3; \alpha_4) = \alpha_1 x_1 + \alpha_2 x_2 + \alpha_3 x_3 + \alpha_4 x_4$  ekanligini, ya'ni to'rt o'lchovli  $(\alpha_1; \alpha_2; \alpha_3; \alpha_4)$  vektor  $x_1, x_2, x_3, x_4$  vektorlar bo'yicha yoyilganligini ko'ramiz.

$L$  chiziqli fazodagi har qanday  $x_1, x_2, x_3, \dots, x_k$  vektorlar sistemasi uchun quyidagi hollar ro'y berishi mumkin:

1)  $L$  chiziqli fazoning har qanday vektorini  $x_1, x_2, x_3, \dots, x_k$  vektorlar bo'yicha yoyish mumkin;

2)  $L$  chiziqli fazoning  $x_1, x_2, x_3, \dots, x_k$  vektorlar bo'yicha yoyilmaydigan biror vektori mavjud.

2-misol.  $R^5$  fazoning  $x_1 = (1; 0; 0; 0; 0), x_2 = (0; 1; 0; 0; 0), \dots, x_5 = (0; 0; 0; 0; 1)$  vektorlarini qaraymiz.  $y = (y_1, y_2, y_3, y_4, y_5)$  vektor shu fazoning ixtiyoriy vektori bo'lsin. U holda

$$y = y_1 x_1 + y_2 x_2 + y_3 x_3 + y_4 x_4 + y_5 x_5$$

tenglikning to'g'ri ekanligini bevosita tekshirib ko'rish mumkin.

$R^5$  fazoning har qanday  $y$  vektorini  $x_1, x_2, x_3, x_4, x_5$  vektorlar bo'yicha yoyish mumkin.

3-misol.  $R^3$  fazodagi  $x_1 = (1; 2; 0), x_2 = (2; 3; 0)$  vektorlar sistemasini qaraymiz.  $y = (1; 1; 2) \in R^3$  vektorni  $x_1, x_2$  vektorlar bo'yicha yoyish mumkin emasligini aniqlaymiz.

Yechish.  $y$  vektorni  $x_1, x_2$  vektorlar bo'yicha yoyish mumkin va yoyilmaning koeffitsiyentlari  $\alpha_1, \alpha_2$  sonlardan iborat deb faraz qilaylik. U holda  $y = \alpha_1 x_1 + \alpha_2 x_2$  yoki  $(1; 1; 2) = (\alpha_1 + 2\alpha_2; 2\alpha_1 + 3\alpha_2; 0)$  tenglik o'rinni bo'ladi. Oxirgi tenglikdan,  $n$  o'lchovli vektorlarning tengligi ta'rifi ko'ra

$$\begin{cases} \alpha_1 + 2\alpha_2 = 1, \\ 2\alpha_1 + 3\alpha_2 = 1, \\ 0 = 2 \end{cases}$$

sistemani hosil qilamiz. Bu sistema ziddiyatlidir. Demak, farazimiz noto'g'ri, ya'ni  $y$  vektorni  $x_1, x_2$  vektorlar bo'yicha yoyish mumkin emas.

Endi chiziqli fazo nol-vektori  $\theta$  ni berilgan  $x_1, x_2, \dots, x_k$  vektorlar bo'yicha yoyish masalasini qaraymiz.

$x_1, x_2, \dots, x_k$  lar  $L$  chiziqli fazoning ixtiyoriy vektorlari bo'lsin.  $\theta$  vektorni shu vektorlar bo'yicha hamma vaqt yoyish mumkin:

$$\theta = 0x_1 + 0x_2 + \dots + 0x_k. \quad (3)$$

$\theta$  vektorni berilgan  $x_1, x_2, \dots, x_k$  vektorlar bo'yicha yoyish faqat bir xil usulda (ya'ni faqat (3) ko'rinishda) yoki bittadan ortiq usulda bajarilishi mumkin.

4 - misol.  $\theta = (0; 0; 0) \in R^3$  vektorni  $x_1 = (2; 0; 0)$ ,  $x_2 = (0; 2; 0)$ ,  $x_3 = (0; 0; 2)$  vektorlar bo'yicha necha xil usulda yoyish mumkinligini aniqlaymiz.

Yechish.  $\theta = \alpha_1 x_1 + \alpha_2 x_2 + \alpha_3 x_3$  yoyilmani qaraymiz. Bu yoyilma o'rinli bo'lishi uchun

$$\begin{aligned} (0; 0; 0) &= \alpha_1(2; 0; 0) + \alpha_2(0; 2; 0) + \alpha_3(0; 0; 2) = \\ &= (2\alpha_1; 0; 0) + (0; 2\alpha_2; 0) + (0; 0; 2\alpha_3) \end{aligned}$$

yoki

$$(0; 0; 0) = (2\alpha_1; 2\alpha_2; 2\alpha_3)$$

tenglik o'rinli bo'lishi kerak.  $n$  o'lchovli vektorlar tengligining ta'rifiga ko'ra, oxirgi tenglik  $\alpha_1 = 0$ ,  $\alpha_2 = 0$ ,  $\alpha_3 = 0$  tengliklar o'rinli bo'lganda va faqat shu holda o'rinlidir. Bu yerdan ko'rinadiki,  $\theta$  vektorni  $x_1, x_2, x_3$  vektorlar bo'yicha  $\theta = 0x_1 + 0x_2 + 0x_3$  ko'rinishdagina, ya'ni faqat bir xil usulda yoyish mumkin.

5 - misol.  $\theta = (0; 0) \in R^2$  vektorni  $x_1 = (1; 2)$ ,  $x_2 = (2; 4)$  vektorlar bo'yicha necha xil usulda yoyish mumkinligini aniqlaymiz.

Yechish.  $\theta = \alpha_1 x_1 + \alpha_2 x_2$  yoyilmani qaraymiz. Bu yoyilma o'rinli bo'lishi uchun

$$(0; 0) = \alpha_1 x_1 + \alpha_2 x_2 = \alpha_1(1; 2) + \alpha_2(2; 4) = (\alpha_1; 2\alpha_2) + (2\alpha_1; 4\alpha_2)$$

yoki

$$(0; 0) = (\alpha_1 + 2\alpha_2; 2(\alpha_1 + 2\alpha_2))$$

tenglik o'rinli bo'lishi kerak. Oxirgi tenglik  $\alpha_1 + 2\alpha_2 = 0$  shartni qanoatlantiruvchi har qanday  $\alpha_1, \alpha_2$  sonlar uchun bajariladi. Bunday  $\alpha_1, \alpha_2$  sonlar esa cheksiz ko'pdir:  $\alpha_1 = t$ ,  $\alpha_2 = -\frac{1}{2}t$  ( $t \in R$ ). Bu yerdan ko'rinadiki,  $\theta$  vektorni  $x_1, x_2$  vektorlar bo'yicha cheksiz ko'p usullar bilan yoyish mumkin ekan.

6 - misol.  $y = (0; 2; 4) \in R^3$  vektorni  $x_1 = (5; 0; 0)$ ,  $x_2 = (0; 5; 0)$ ,  $x_3 = (0; 0; 5)$  vektorlar bo'yicha yoyamiz.

Yechish.  $y = \alpha_1 x_1 + \alpha_2 x_2 + \alpha_3 x_3$  izlangan yoyilma bo'lsin. U holda

$$(0; 2; 4) = (5\alpha_1; 0; 0) + (0; 5\alpha_2; 0) + (0; 0; 5\alpha_3)$$

yoki

$$(5\alpha_1; 5\alpha_2; 5\alpha_3) = (0; 2; 4)$$

tenglik o'rinli bo'ladi. Bu tenglik 
$$\begin{cases} 5\alpha_1 = 0, \\ 5\alpha_2 = 2, \text{ yoki } \alpha_1 = 0, \alpha_2 = 0.4, \alpha_3 = \\ 5\alpha_3 = 4 \end{cases}$$

$= 0,8$  bo'lgandagina bajariladi. Demak,  $y = 0 \cdot x_1 + 0,4 \cdot x_2 + 0,8 \cdot x_3$ .

7-misol.  $L$  chiziqli fazoning nol-vektori  $\theta$  ni  $x_1; x_2; \dots, x_{k-1}; \theta$  vektorlar bo'yicha necha xil usulda yoyish mumkinligini aniqlaymiz.

**Yechish.**  $\theta = 0 \cdot x_1 + 0 \cdot x_2 + \dots + 0 \cdot x_{k-1} + \alpha \cdot \theta$  yoyilmani kuzatib, bu yoyilma  $\alpha$  ning har qanday haqiqiy qiymati uchun o'rinli bo'lishini ko'ramiz. Demak,  $\theta$  vektorni berilgan  $x_1; x_2; \dots, x_{k-1}; \theta$  vektorlar bo'yicha cheksiz ko'p usulda yoyish mumkin.

$L$  chiziqli fazoning  $x_1, x_2, \dots, x_k$  vektorlari uchun

$$\alpha_1 x_1 + \alpha_2 x_2 + \dots + \alpha_k x_k = \theta \quad (4)$$

tenglik  $\alpha_1 = \alpha_2 = \dots = \alpha_k = 0$  bo'lgan holdagina bajarilsa, ya'ni nol-vektor  $\theta$  ni  $x_1, x_2, \dots, x_k$  vektorlar bo'yicha faqat bir xil usulda yoyish mumkin bo'lsa,  $x_1, x_2, \dots, x_k$  vektorlar sistemasi *chiziqli erkli* deyiladi. Agar (4) tenglik kamida bittasi nolga teng bo'lmagan  $\alpha_1, \alpha_2, \dots, \alpha_k$  sonlar uchun bajarilsa, ya'ni nol-vektor  $\theta$  ni  $x_1, x_2, \dots, x_k$  vektorlar bo'yicha bittadan ortiq usulda yoyish mumkin bo'lsa,  $x_1, x_2, \dots, x_k$  vektorlar sistemasi *chiziqli bog'liq* deyiladi.

4-misoldagi  $x_1, x_2, x_3$  vektorlar chiziqli erkli, 5-misoldagi  $x_1, x_2$  vektorlar esa chiziqli bog'liq vektorlar sistemasidir.

7-misoldan ko'rinadiki, har qanday  $L$  chiziqli fazoning tarkibida nol-vektor qatnashgan har qanday  $x_1, x_2, \dots, x_{k-1}, x_k$  vektorlar sistemasi chiziqli bog'liqdir.

8-misol.  $x_1 = (2; 4; 1), x_2 = (1; 3; 6), x_3 = (5; 3; 1)$  vektorlarning chiziqli erkli ekanligini isbotlaymiz.

**Yechish.**  $\theta = \alpha_1 x_1 + \alpha_2 x_2 + \alpha_3 x_3$  tenglikni tuzamiz:

$$(0; 0; 0) = (2\alpha_1 + \alpha_2 + 5\alpha_3; 4\alpha_1 + 3\alpha_2 + 3\alpha_3; \alpha_1 + 6\alpha_2 + \alpha_3).$$

Oxirgi tenglik quyidagi tengliklar o'rinli bo'lgandagina bajariladi:

$$\begin{cases} 2\alpha_1 + \alpha_2 + 5\alpha_3 = 0, \\ 4\alpha_1 + 3\alpha_2 + 3\alpha_3 = 0, \\ \alpha_1 + 6\alpha_2 + \alpha_3 = 0. \end{cases}$$

Bu sistemani yechib,  $\alpha_1 = 0$ ,  $\alpha_2 = 0$ ,  $\alpha_3 = 0$  ekanligini topamiz. Demak,  $\theta$  vektorni  $x_1$ ,  $x_2$ ,  $x_3$  vektorlar bo'yicha faqat bir xil usulda yoyish mumkin. Bu esa  $x_1$ ,  $x_2$ ,  $x_3$  vektorlarning chiziqli erkli ekanligini ko'rsatadi.

**Teorema.** *L chiziqli fazoning  $x_1, x_2, \dots, x_k$  ( $k > 1$ ) vektorlar sistemasi chiziqli bog'liq bo'lsa, u holda bu vektorlarning hech bo'lmaganda bittasi qolganlari orqali yoyiladi va, aksincha, L chiziqli fazoning  $x_1, x_2, \dots, x_k$  ( $k > 1$ ) vektorlaridan birortasi qolganlari orqali yoyilsa, bu vektorlar chiziqli bog'liq sistema hosil qiladi.*

**Isbot.**  $x_1, x_2, \dots, x_k$  ( $k > 1$ ) vektorlar sistemasi chiziqli bog'liq bo'lsin. U holda,  $\alpha_1 x_1 + \alpha_2 x_2 + \dots + \alpha_k x_k = \theta$  tenglik o'rinli va  $\alpha_1, \alpha_2, \dots, \alpha_k$  sonlardan kamida bittasi noldan farqli bo'ladi. Umumiylikni saqlagan holda,  $\alpha_1 \neq 0$  deb hisoblaymiz.

$\alpha_1 \neq 0$  bo'lgani uchun

$$x_1 = \frac{\alpha_2}{\alpha_1} x_2 - \frac{\alpha_3}{\alpha_1} x_3 - \dots - \frac{\alpha_k}{\alpha_1} x_k$$

tenglikka ega bo'lamiz. Demak,  $x_1$  vektor qolgan vektorlar bo'yicha yoyiladi.

Endi  $x_1, x_2, \dots, x_k$  ( $k > 1$ ) vektorlarning birortasi, masalan,  $x_1$  vektor qolganlari orqali yoyilsin:

$$x_1 = \alpha_2 x_2 + \alpha_3 x_3 + \dots + \alpha_k x_k.$$

U holda,  $-x_1 + \alpha_2 x_2 + \alpha_3 x_3 + \dots + \alpha_k x_k = \theta$  tenglik hosil bo'ladi, ya'ni (4) tenglik  $\alpha_1 = -1 \neq 0$  da o'rinli bo'ladi. Demak,  $x_1, x_2, \dots, x_k$  vektorlar chiziqli bog'liq bo'ladi.

**9 - misol.**  $x_1 = (1; 2; 3)$ ,  $x_2 = (3; 4; 5)$ ,  $x_3 = (5; 6; 7)$  vektorlarning chiziqli bog'liq ekanligini isbotlaymiz.

**Yechish.**  $\theta = \alpha_1 x_1 + \alpha_2 x_2 + \alpha_3 x_3$  yoyilmani qaraymiz.

$$\alpha_1 x_1 + \alpha_2 x_2 + \alpha_3 x_3 = (\alpha_1 + 3\alpha_2 + 5\alpha_3; 2\alpha_1 + 4\alpha_2 + 6\alpha_3; 3\alpha_1 + 5\alpha_2 + 7\alpha_3)$$

bo'lgani uchun, qaralayotgan yoyilma  $\alpha_1, \alpha_2, \alpha_3$  ning

$$\begin{cases} \alpha_1 + 3\alpha_2 + 5\alpha_3 = 0, \\ 2\alpha_1 + 4\alpha_2 + 6\alpha_3 = 0, \\ 3\alpha_1 + 5\alpha_2 + 7\alpha_3 = 0 \end{cases}$$

sistemani qanoatlantiruvchi qiymatlaridagina o‘rinli bo‘ladi. Sistemaning asosiy determinanti nolga teng:

$$\Delta = \begin{vmatrix} 1 & 3 & 5 \\ 2 & 4 & 6 \\ 3 & 5 & 7 \end{vmatrix} = 0.$$

Shuning uchun sistema cheksiz ko‘p yechimga ega. Bu yerdan,  $\theta$  vektorni  $x_1, x_2, x_3$  vektorlar bo‘yicha cheksiz ko‘p usullar bilan yoyish mumkinligi, ya‘ni  $x_1, x_2, x_3$  vektorlarning chiziqli bog‘liqligi kelib chiqadi.

10 - misol.  $x_1 = (-2; 3), x_2 = (-8; 12)$  vektorlarning chiziqli bog‘liq ekanligini isbotlaymiz.

Yechish.  $x_2$  vektorni  $x_1$  vektor orqali yoyish mumkin:  $x_2 = 4x_1$ . Isbotlangan teorema ko‘ra,  $x_1, x_2$  vektorlar chiziqli bog‘liqdir.



## Mashqlar

**10.41.** 1)  $R^3$  fazodagi  $x_1 = (1; 2; 3), x_2 = (0; 2; 3), x_3 = (0; 0; 1)$  vektorlarning koeffitsiyentlari 1; 5;  $-2$  bo‘lgan chiziqli kombinatsiyasi  $R^3$  fazoning qanday vektoriga teng bo‘lishini aniqlang.

2)  $R^4$  fazodagi  $x_1 = (1; 2; 3; 0), x_2 = (0; 1; 4; 0)$  vektorlarning koeffitsiyentlari 1, 0 bo‘lgan chiziqli kombinatsiyasi  $R^3$  fazoning qanday vektoriga teng bo‘lishini aniqlang.

**10.42.** 1)  $y = (1; 2; 3) \in R^3$  vektorni  $x_1 = (1; 0; 0), x_2 = (0; 1; 0), x_3 = (0; 0; 1)$  vektorlar bo‘yicha;

2)  $y = (0; 1; 3) \in R^3$  vektorni  $x_1 = (3; 0; 0), x_2 = (0; 3; 0), x_3 = (0; 0; 3)$  vektorlar bo‘yicha yoying.

**10.43.** 1)  $y = (1; -1; 0)$  vektorni  $x_1 = (0; 0; 1), x_2 = (0; 1; 0)$  vektorlar bo‘yicha;

2)  $y = (1; -1; -1)$  vektorni  $x_1 = (3; 0; 0), x_2 = (0; 3; 0), x_3 = (0; 0; 3)$  vektorlar bo‘yicha yoyish mumkinmi?

**10.44.** 1)  $\theta = (0; 0; 0)$  vektorni  $x_1 = (-1; 0; 0)$ ,  $x_2 = (0; -1; 0)$ ,  $x_3 = (0; 0; -1)$  vektorlar bo'yicha;

2)  $\theta = (0; 0; 0; 0)$  vektorni  $x_1 = (-1; 0; 0; 0)$ ,  $x_2 = (0; -1; 0; 0)$ ,  $x_3 = (0; 0; -1; 0)$ ,  $x_4 = (0; 0; 0; -1)$  vektorlar bo'yicha necha xil usulda yoyish mumkin?

**10.45.**  $x_1, x_2, x_3 \in R^3$  vektorlarning chiziqli erkli ekanligini isbotlang, bunda:

1)  $x_1 = (1; 2; 3)$ ,  $x_2 = (-1; 3; 2)$ ,  $x_3 = (7; -3; 5)$ ;

2)  $x_1 = (4; 7; 8)$ ,  $x_2 = (9; 1; 3)$ ,  $x_3 = (2; -4; 1)$ ;

3)  $x_1 = (8; 2; 3)$ ,  $x_2 = (4; 6; 10)$ ,  $x_3 = (3; -2; 1)$ ;

4)  $x_1 = (10; 3; 1)$ ,  $x_2 = (1; 4; 2)$ ,  $x_3 = (3; 9; 2)$ .

**10.46.**  $x_1, x_2, x_3 \in R^3$  vektorlarning chiziqli bog'liq ekanligini isbotlang, bunda:

1)  $x_1 = (1; 2; 3)$ ,  $x_2 = (2; 4; 6)$ ,  $x_3 = (0; 1; 2)$ ;

2)  $x_1 = (1; 1; 2)$ ,  $x_2 = (0; 1; 3)$ ,  $x_3 = (2; 2; 4)$ ;

3)  $x_1 = (1; 2; 3)$ ,  $x_2 = (8; 13; 18)$ ,  $x_3 = (2; 3; 4)$ ;

4)  $x_1 = (-1; 1; 3)$ ,  $x_2 = (2; -3; 1)$ ,  $x_3 = (-4; 5; 5)$ .

**10.47.**  $x_1, x_2 \in R^2$  vektorlarning chiziqli bog'liq ekanligini isbotlang, bunda:

1)  $x_1 = (1; 2)$ ,  $x_2 = (2; 4)$ ;                      2)  $x_1 = (0; 1)$ ,  $x_2 = (0; 3)$ ;

3)  $x_1 = (-2; 4)$ ,  $x_2 = (-6; 12)$ ;            4)  $x_1 = (1; 3)$ ,  $x_2 = (4; 12)$ ;

5)  $x_1 = (-1; 2)$ ,  $x_2 = (-2; 4)$ ;            6)  $x_1 = (-3; 2)$ ,  $x_2 = (-9; 6)$ .

**10.48.**  $L$  chiziqli fazoning  $x_1, x_2, \dots, x_k, x_{k+1}, \dots, x_n$  vektorlari sistemasining biror qismi chiziqli bog'liq bo'lsa, sistemaning o'zi ham chiziqli bog'liq bo'lishini isbotlang.

**3. Chiziqli fazoning o'lchovi va bazisi.**  $R^1 = R$  chiziqli fazoning  $x_1 = 5$  vektorini qaraymiz. Bu vektor uning bitta vektoridan tuzilgan chiziqli erkli sistemasi bo'ladi, chunki  $\alpha_1 x_1 = 0$  yoki  $\alpha_1 \cdot 5 = 0$  tenglik  $\alpha_1 = 0$  bo'lgandagina bajariladi.

Endi  $R^1 = R$  fazoning ixtiyoriy ikkita  $x_1, x_2$  vektorlarini olib, ularning chiziqli bog'liq yoki chiziqli erkli ekanligini tekshiraylik.

Agar  $x_1 = 0$  yoki  $x_2 = 0$  bo'lsa,  $x_1, x_2$  sistema chiziqli bog'liqdir (2-band).

$x_1 \neq 0$  va  $x_2 \neq 0$  bo'lsin. U holda  $\alpha_1 x_1 + \alpha_2 x_2 = 0$  tenglik  $\alpha_1, \alpha_2$  larning cheksiz ko'p qiymatlarida bajariladi, chunki ixtiyoriy  $t \in R$

haqiqiy son olmaylik,  $\alpha_1 = t$ ,  $\alpha_2 = -\frac{x_1}{x_2}t$  sonlar qaralayotgan tenglikni qanoatlantiradi. Bu yerdan,  $x_1 \neq 0$ ,  $x_2 \neq 0$  bo'lganda ham  $x_1, x_2$  sistema chiziqli bog'liq ekanligini ko'ramiz.

Shunday qilib,  $R^1 = R$  fazoning har qanday ikkita  $x_1, x_2$  vektori chiziqli bog'liq sistema hosil qiladi.

Yuqoridagi mulohazalardan ko'rinadiki,  $R^1$  dagi har qanday nolmas vektor chiziqli erkli sistema hosil qiladi va har qanday ikkita vektor chiziqli bog'liq bo'ladi.

Agar  $L$  chiziqli fazoda chiziqli erkli sistema hosil qiluvchi biror  $n$  ta vektor topish mumkin bo'lib,  $L$  chiziqli fazoning har qanday  $n + 1$  ta vektori chiziqli bog'liq sistema hosil qilsa,  $L$  chiziqli fazo  $n$  o'lchovli fazo deyiladi.

$R^1 = R$  chiziqli fazo (to'g'ri chiziq) bir o'lchovli chiziqli fazo ekanligi yuqorida isbotlandi.

Chiziqli algebra kursida  $R^n$  arifmetik chiziqli fazoning  $n$  o'lchovli chiziqli fazo ekanligi isbotlanadi. Shunga ko'ra  $R^2$  chiziqli fazo (tekislik) ikki o'lchovli chiziqli fazo,  $R^3$  fazo (biz yashab turgan fazo) uch o'lchovli chiziqli fazodir.

$n$  o'lchovli  $L$  chiziqli fazoning chiziqli erkli  $n$  ta vektorlar sistemasi uning bazisi deyiladi.

**T e o r e m a .**  *$n$  o'lchovli chiziqli fazoning har qanday vektorini uning bazis vektorlari bo'yicha yoyish mumkin va bu yoyilma yagonadir.*

**I s b o t .**  $x_1, x_2, \dots, x_k$  vektorlar sistemasi  $n$  o'lchovli  $L$  chiziqli fazoning biror bazisi,  $y$  esa shu fazoning ixtiyoriy vektori bo'lsin.  $x_1, x_2, \dots, x_n, y$  vektorlar sistemasi  $n + 1$  ta vektordan iborat va, demak, chiziqli bog'liqdir, ya'ni

$$\alpha_1 x_1 + \alpha_2 x_2 + \dots + \alpha_n x_n + \alpha_{n+1} y = \theta \quad (1)$$

tenglik orasida nolga teng bo'lmaganlari ham mavjud bo'lgan  $\alpha_1, \alpha_2, \dots, \alpha_n, \alpha_{n+1}$  koeffitsiyentlar uchun bajariladi.  $\alpha_{n+1}$  son nolga teng bo'lmagan koeffitsiyentlar safiga albatta kiradi, chunki  $\alpha_{n+1} = 0$  bo'lsa, koeffitsiyentlari orasida noldan farqlilari mavjud bo'lgan va  $x_1, x_2, \dots, x_k$  vektorlarning chiziqli erkliligini inkor etadigan

$$\alpha_1 x_1 + \alpha_2 x_2 + \dots + \alpha_n x_n = \theta$$

tenglikka ega bo'lamiz. Demak, (1) tenglikdan

$$y = \frac{\alpha_1}{\alpha_{n+1}} x_1 - \frac{\alpha_2}{\alpha_{n+1}} x_2 - \dots - \frac{\alpha_n}{\alpha_{n+1}} x_n$$

tenglikni yoki

$$y = \lambda_1 x_1 + \lambda_2 x_2 + \dots + \lambda_n x_n \quad (2)$$

tenglikni yozish mumkin. (2) tenglik  $y$  vektorning bazis vektorlar bo'yicha yoyilmasidan iboratdir. Bu yoyilmaning yagonaligini isbotlaymiz.

$y$  vektor (2) dan boshqa, yana bir

$$y = \lambda'_1 x_1 + \lambda'_2 x_2 + \dots + \lambda'_n x_n \quad (3)$$

yoyilmaga ega bo'lsin. (2) va (3) tengliklardan quyidagiga ega bo'lamiz:

$$y - y = 0 = (\lambda_1 - \lambda'_1)x_1 + (\lambda_2 - \lambda'_2)x_2 + \dots + (\lambda_n - \lambda'_n)x_n.$$

$x_1, x_2, \dots, x_n$  vektorlar sistemasi chiziqli erkli bo'lgani uchun oxirgi tenglikdan

$$\lambda_1 - \lambda'_1 = 0, \lambda_2 - \lambda'_2 = 0, \dots, \lambda_n - \lambda'_n = 0$$

yoki

$$\lambda_1 = \lambda'_1, \lambda_2 = \lambda'_2, \dots, \lambda_n = \lambda'_n$$

ekanligi, ya'ni  $y$  vektorning  $x_1, x_2, \dots, x_n$  bazis vektorlar bo'yicha har qanday yoyilmasi (2) yoyilma bilan ustma-ust tushishi kelib chiqadi. Demak,  $y$  vektorni  $x_1, x_2, \dots, x_n$  bazis vektorlar bo'yicha yoyish mumkin va bu yoyilma yagonadir.

$n$  o'lchovli chiziqli fazo vektorining berilgan bazis vektorlari bo'yicha yoyilmasidagi koeffitsiyentlar shu vektorning berilgan bazisdagi koordinatalari deyiladi.

Chiziqli algebra kursida  $R^n$  fazodagi  $x_1 = (a_{11}, a_{12}, \dots, a_{1n})$ ,  $x_2 = (a_{21}, a_{22}, \dots, a_{2n})$ , ...,  $x_n = (a_{n1}, a_{n2}, \dots, a_{nn})$  vektorlarning shu fazoda bazis tashkil etishi uchun

$$\Delta = \begin{vmatrix} a_{11} & a_{12} & \dots & a_{1n} \\ a_{21} & a_{22} & \dots & a_{2n} \\ \dots & \dots & \dots & \dots \\ a_{n1} & a_{n2} & \dots & a_{nn} \end{vmatrix} \neq 0 \quad (4)$$

determinantning noldan farqli bo'lishligi zarur va yetarli ekanligi isbotlanadi.

**Misol.**  $R^3$  fazoning  $x_1 = (1; -2; 3)$ ,  $x_2 = (4; 7; 2)$ ,  $x_3 = (6; 4; 2)$  va  $y = (-9; 0; 1)$  vektorlari berilgan.  $x_1, x_2, x_3$  vektorlarning bazis



tashkil etishini isbotlaymiz va  $y$  vektorning shu bazisdagi koordinatalarini topamiz.

**Yechish.**  $x_1, x_2, x_3$  vektorlarning berilgan koordinatalaridan tuzilgan determinantni hisoblaymiz:

$$\Delta = \begin{vmatrix} 1 & -2 & 3 \\ 4 & 7 & 2 \\ 6 & 4 & 2 \end{vmatrix} = 14 - 24 + 48 - 126 - 8 + 16 = -80.$$

$\Delta = -80 \neq 0$  bo'lgani uchun,  $x_1, x_2, x_3$  vektorlar bazis tashkil etadi.  $y$  vektorning shu bazisdagi koordinatalari  $\alpha_1, \alpha_2, \alpha_3$ , ya'ni  $y = \alpha_1 x_1 + \alpha_2 x_2 + \alpha_3 x_3$  bo'lsin. U holda  $(-9; 0; 1) = (\alpha_1 + 4\alpha_2 + 6\alpha_3;$

$$-2\alpha_1 + 7\alpha_2 + 4\alpha_3; 3\alpha_1 + 2\alpha_2 + 2\alpha_3) \text{ yoki } \begin{cases} \alpha_1 + 4\alpha_2 + 6\alpha_3 = 9, \\ -2\alpha_1 + 7\alpha_2 + 4\alpha_3 = 0, \\ 3\alpha_1 + 2\alpha_2 + 2\alpha_3 = 1 \end{cases}$$

bo'ladi. Bu sistemani yechib,  $\alpha_1 = 1, \alpha_2 = 2, \alpha_3 = -3$  ekanligini topamiz. Demak,  $y$  vektorning izlangan koordinatalari  $(1; 2; -3)$  ekan:  $y = (1; 2; -3)$ .



## Mashqlar

**10.49.**  $R^3$  fazoning  $x_1, x_2, x_3$  va  $y$  vektorlari berilgan.  $x_1, x_2, x_3$  vektorlarining bazis tashkil etishini isbotlang va  $y$  vektorning shu bazisdagi koordinatalarini toping.

- 1)  $x_1 = (1; 2; 3), x_2 = (-1; 3; 2),$   
 $x_3 = (7; 3; 5), y = (8; 4; 13);$
- 2)  $x_1 = (8; 2; 3), x_2 = (4; 6; 10),$   
 $x_3 = (3; -2; 1), y = (7; 4; 11);$
- 3)  $x_1 = (2; 4; 1), x_2 = (1; 3; 6),$   
 $x_3 = (5; 3; 1), y = (6; 12; 3);$
- 4)  $x_1 = (1; -2; 3), x_2 = (4; 7; 2),$   
 $x_3 = (6; 4; 2), y = (14; 18; 6);$
- 5)  $x_1 = (7; 2; 1), x_2 = (4; 3; 5),$   
 $x_3 = (3; 4; -2), y = (24; 20; -5).$

**10.50.** Tekislikdagi barcha vektorlar (yo'naltirilgan kesmalar)dan tuzilgan chiziqli fazodagi har qanday ikkita nokollinear vektor shu fazoning bazisini tashkil etishini isbotlang.



## TEST SAVOLLARIDAN NAMUNALAR

1.  $b$  soni  $f(x)$  funksiyaning  $x \rightarrow +\infty$  dagi limiti deyiladi, agar har qanday  $\varepsilon > 0$  son uchun shunday:

- A)  $(M; +\infty)$  oraliq topilsaki, unda  $f(x) - b < \varepsilon$  tengsizlik bajarilsa;
- B)  $(M; +\infty)$  oraliq topilsaki, unda  $|f(x) - b| < \varepsilon$  tengsizlik bajarilsa;
- D)  $(M; -\infty)$  oraliq topilsaki, unda  $|f(x) - b| < \varepsilon$  tengsizlik bajarilsa;
- E)  $(M; -\infty)$  oraliq topilsaki, unda  $f(x) - b < \varepsilon$  tengsizlik bajarilsa;
- F)  $(M; +\infty)$  oraliq topilsaki, unda  $|f(x) - b| > \varepsilon$  tengsizlik bajarilsa.

2. Agar  $f(x)$  va  $\varphi(x)$  funksiyalar  $x \rightarrow a$  da mos ravishda  $b$  va  $c$  ga teng limitlarga ega bo'lsa, ularning  $f(x) + g(x)$  yig'indisi

- A)  $x \rightarrow +\infty$  da  $b + c$  limitga ega bo'ladi;
- B)  $x \rightarrow -\infty$  da  $b + c$  limitga ega bo'ladi;
- D)  $x \rightarrow \infty$  da  $b + c$  limitga ega bo'ladi;
- E)  $x \rightarrow a$  da  $b + c$  limitga ega bo'ladi;
- F)  $x \rightarrow a$  da  $|b + c|$  limitga ega bo'ladi.

3.  $f(x)$  funksiya  $x = a$  nuqtada uzluksiz deyiladi,

- A) agar  $f(x) = f(a)$  bo'lsa;
- B) agar  $f(a - 0) \neq f(a + 0)$  bo'lsa;
- D) agar  $\lim_{x \rightarrow a} f(x) = \infty$  bo'lsa;
- E) agar  $\lim_{x \rightarrow a} f(x) = -f(x)$  bo'lsa;
- F) agar  $f(x)$  funksiya  $x = a$  nuqtada aniqlangan va  $f(x) - f(a)$  ayirma  $x \rightarrow a$  da cheksiz kichik bo'lsa.

4. Agar  $f(x)$  va  $g(x)$  funksiyalar  $x = a$  nuqtada aniqlangan bo'lsa, u holda

- A) ularning faqat yig'indisi (ayirmasi va ko'paytmasi emas) shu nuqtada uzluksiz bo'lishi mumkin;
- B) ularning yig'indisi va ayirmasi (ko'paytmasi emas) shu nuqtada uzluksiz bo'lishi mumkin;
- D) ularning yig'indisi, ayirmasi, ko'paytmasi ham shu nuqtada uzluksiz bo'ladi;
- E) ularning yig'indisi, ayirmasi, ko'paytmasi ham shu nuqtada uzluksiz bo'lishi mumkin;
- F) ularning yig'indisi, ayirmasi, ko'paytmasi shu nuqta yotgan oraliqda uzluksiz bo'ladi.

5. Agar  $f(x)$  va  $g(x)$  funksiyalar  $x = a$  nuqtada uzluksiz bo'lsa, u holda

- A)  $\frac{f(x)}{g(x)}$  funksiya ham shu nuqtada uzluksiz bo'ladi;
- B)  $\frac{f(x)}{g(x)}$  va  $\frac{g(x)}{f(x)}$  funksiyalar ham shu nuqtada uzluksiz bo'ladi;
- D)  $\frac{1}{f(x)} \cdot \frac{1}{g(x)}$  funksiya ham shu nuqtada uzluksiz bo'ladi;
- E)  $g(x) \neq 0$  bo'lganda  $\frac{f(x)}{g(x)}$  funksiya ham shu nuqtada uzluksiz bo'ladi;
- F)  $f(x) \neq 0$  bo'lganda  $\frac{f(x)}{g(x)}$  funksiya ham shu nuqtada uzluksiz bo'ladi.

6. Oraliqning (intervalning) barcha nuqtalarida uzluksiz bo'lgan funksiya

- A) shu oraliqning (intervalning) ayrim nuqtalarida uzluksiz deyiladi;
- B) shu oraliqning (intervalning) faqat nuqtalarida uzluksiz deyiladi;
- D) shu oraliqning (intervalning) faqat o'rtasida uzluksiz deyiladi;
- E) shu oraliqda (intervalda) uzluksiz deyiladi;
- F) shu oraliqning faqat ko'rsatilgan qismida uzluksiz bo'ladi, deyiladi.

7. Agar  $x$  radianlarda berilgan bo'lsa, u holda  $\lim_{x \rightarrow 0} \frac{\sin x}{x} =$

- A) 0;      B) 1;      D) -1;      E)  $-\infty$ ;      F)  $+\infty$ .

8. Agar  $x$  radianlarda berilgan bo'lsa, u holda  $\lim_{x \rightarrow a} \sin x =$

- A)  $a$ ;      B)  $\sin a$ ;      D)  $\frac{\sin x}{a}$ ;      E)  $a \sin x$ ;      F)  $\sin \frac{x}{2}$ .

9. Agar  $\alpha(x)$  o'zgarmas funksiya  $x \rightarrow +\infty$  da cheksiz kichik bo'lsa,

- A)  $x$  ning barcha qiymatlarida  $\alpha(x) = 0$  bo'ladi;
- B)  $x$  ning barcha qiymatlari  $\alpha(x) = +\infty$  bo'ladi;
- D)  $x = 0$  da  $\alpha(x) = 0$  bo'ladi;
- E)  $x = 0$  da  $\alpha(x) = -\infty$  bo'ladi;
- F)  $x = 0$  da  $\alpha(x) = 1$  bo'ladi.

10. Agar  $P(x) = a_m x^m + a_{m-1} x^{m-1} + \dots + a_0$  va  $Q(x) = b_n x^n + b_{n-1} x^{n-1} + \dots + b_0$ ,  $a_m \neq 0$ ,  $b_n \neq 0$  va ko'phadlarning darajalari  $m < n$  bo'lsa, u holda  $\lim_{x \rightarrow \infty} \frac{P(x)}{Q(x)} = \dots$  bo'ladi.

- A)  $\frac{m}{n}$ ;    B)  $\frac{a_0}{b_0}$ ;    D)  $\frac{a_m}{b_n}$ ;    E) 0;    F)  $\infty$ .

11.  $a$  ning  $h$  radiusli teshilgan (o'yilgan) atrofi

- A) shu nuqtaning o'zi chiqarib tashlangan atrofidan iborat;  
 B)  $(a - h; a)$  va  $(a; a + h)$  oraliqlarning birlashmasidan iborat;  
 D)  $(-\infty; a)$  va  $(a; +\infty)$  oraliqlarning birlashmasidan iborat;  
 E)  $(-\infty; h)$  va  $(h; +\infty)$  oraliqlarning birlashmasidan iborat;  
 F)  $(-h; a)$  va  $(a; h)$  oraliqlarning birlashmasidan iborat.

12. Agar  $[a; b)$  yarim intervalda berilgan  $f(x)$  funksiya uchun

$\lim_{x \rightarrow b-0} f(x) = +\infty$  bo'lsa,  $x = b$  to'g'ri chiziq  $f(x)$  funksiya grafigi uchun:

- A) gorizontal asimptota;    B) vertikal asimptota;  
 D) gorizontal urinma;    E) vertikal urinma;  
 F) og'ma asimptota.

13. Agar  $f$  funksiya  $[a; b]$  kesmada o'suvchi (kamayuvchi) va uzluksiz bo'lsa, u holda shu funksiyaga

- A)  $[a; b]$  kesmada (mos ravishda  $[b; a]$  kesmada) aniqlangan  $f^{-1}$  teskari funksiya mavjud;  
 B)  $[a; b]$  kesmada aniqlangan  $f^{-1}$  teskari funksiya mavjud;  
 D)  $[f(a); f(b)]$  kesmada (mos ravishda  $[f(b); f(a)]$  kesmada) aniqlangan  $f^{-1}$  teskari funksiya mavjud bo'ladi;  
 E)  $[f(b); f(a)]$  kesmada (mos ravishda  $[f(a); f(b)]$  kesmada) aniqlangan  $f^{-1}$  teskari funksiya mavjud;  
 F)  $[f(a); f(b)]$  kesmada aniqlangan  $f^{-1}$  teskari funksiya mavjud.

14.  $\lim_{x \rightarrow 1} \frac{x^6 - 1}{x^3 - 1} = \dots$

- A) 0;    B) 2;    D) 3;    E)  $+\infty$ ;    F)  $-\infty$ .

15.  $f(x) = kx + b$  to'g'ri chiziq  $f$  funksiya grafigining  $x \rightarrow \infty$  dagi og'ma asimptotasi bo'lishi uchun ... bo'lishi zarur va yetarli.

- A)  $k = \lim_{x \rightarrow \infty} f(x)$ ,  $b = \lim_{x \rightarrow \infty} (f(x) - k)$ ;  
 B)  $k = x$ ,  $b = \lim_{x \rightarrow \infty} f(x)$ ;

$$D) k = \lim_{x \rightarrow \infty} (f(x) - b), \quad b = \lim_{x \rightarrow \infty} (f(x) - kx);$$

$$D) k = \lim_{x \rightarrow \infty} \left( \frac{f(x)}{x} - b \right), \quad b = \lim_{x \rightarrow \infty} \frac{f(x)}{x};$$

$$E) k = \lim_{x \rightarrow \infty} \frac{f(x)}{x}, \quad b = \lim_{x \rightarrow \infty} (f(x) - kx).$$

16.  $f(x)$  funksiyaning  $x = a$  nuqtada chapdan (shu kabi o'ngdan) uzluksiz bo'lishi uchun ... bo'lishi zarur.

A)  $f(a - 0) = f(0)$  (mos ravishda  $f(a + 0) = f(0)$ );

B)  $f(a - 0) = 0$  (mos ravishda  $f(a + 0) = 0$ );

C)  $f(a - 0) \neq f(a + 0)$ ;

D)  $f(a - 0) = f(a + 0)$ ;

E)  $f(a - 0) = f(a)$  (mos ravishda  $f(a + 0) = f(a)$ ).

17. Agar  $f(x)$  funksiya  $[a; b]$  kesmada uzluksiz, monoton va  $f(a)f(b) < 0$  bo'lsa, funksiya shu oraliqning ... nuqtasida nolga aylanadi.

A) faqat bir;

B) tasodifan bir;

D) hech bir nuqtasida nolga aylanmaydi;

E)  $f(a)f(b) > 0$  bo'lsa, bir;

F) kamida bir.

18.  $y = f(x)$  funksiyada  $x = x_0$  nuqtada olingan  $f'(x_0)$  hosila deb

A) har qanday  $\lim_{\Delta x \rightarrow 0} \frac{\Delta y}{\Delta x}$  limitga aytiladi, bunda  $\Delta y = f(x + \Delta x) - f(x)$  funksiya orttirmasi,  $\Delta x$  - argument orttirmasi;

B)  $\frac{\Delta y}{\Delta x}$  nisbatga aytiladi, bunda  $\Delta y$  - funksiya orttirmasi,  $\Delta x$  - argument orttirmasi;

D) chekli  $\lim_{\Delta x \rightarrow 0} \frac{\Delta y}{\Delta x}$  limitga aytiladi, bunda  $\Delta y$  - funksiya orttirmasi,  $\Delta x$  - argument orttirmasi;

E) chekli  $\lim_{x \rightarrow \infty} (\Delta y - \Delta x)$  limitga aytiladi, bunda  $\Delta y$  - funksiya orttirmasi,  $\Delta x$  - argument orttirmasi;

F)  $\lim_{x \rightarrow \infty} \frac{\Delta y}{\Delta x}$  limitga aytiladi, bunda  $\Delta y$  - funksiya orttirmasi,  $\Delta x$  - argument orttirmasi.

19. Agar biror  $y$  kattalik  $y = f(x)$  qonun bo'yicha o'zgarayotgan bo'lsa, bu kattalikning  $x = x_0$  dagi o'zgarish oniy tezligi ... ga teng.

A)  $f(x_0)$ ; B)  $\frac{\Delta f(x_0)}{\Delta x_0}$ ; D)  $f'(x_0)$ ; E)  $f(x_0 + \Delta x) - f(x_0)$ ; F)  $\frac{f(x_0)}{x_0}$ .

20.  $A(x_0; y_0)$  nuqtada  $y = f(x)$  egri chiziqqa o'tkazilgan urinmaning  $k$  burchak koeffitsiyenti ... ga teng.

A)  $\frac{f(x_0)}{x_0}$ ; B)  $f(x_0 + \Delta x) - f(x_0)$ ; D)  $f(x_0)$ ; E)  $f'(x_0)$ ; F)  $\frac{\Delta f(x_0)}{\Delta x_0}$ .

21. Agar  $f(x)$  va  $g(x)$  funksiyalar  $f'(x)$ ,  $g'(x)$  hosilalari mavjud bo'lsa, u holda  $(f(x) \pm g(x))' =$

A)  $f'(x) \cdot g'(x)$ ; B)  $f'(x) \pm g'(x)$ ; D)  $f'(x \pm y)$ ; E)  $g'(x \pm y)$ ; F)  $f(x) \pm g(x)$ .

22. Agar  $f'(x)$  va  $g'(x)$  hosilalar mavjud bo'lsa,  $(f(x)g(x))' =$

A)  $f'(x)g'(x)$ ; B)  $f'(x)g'(x) + C$ ,  $C$  - o'zgarmas;  
 D)  $f'(x)f(x) + g'(x)g(x)$ ; E)  $f'(x)g(x) + g'(x)f(x)$ ;  
 F)  $f'(x)g'(x) + f(x)g(x)$ .

23. Agar  $f'(x)$  va  $g'(x)$  hosilalar mavjud va  $g(x) \neq 0$  bo'lsa,  $\left(\frac{f(x)}{g(x)}\right)' =$

A)  $\frac{f'(x)}{g'(x)}$ ; B)  $\frac{f'(x)}{g(x)}$ ;  
 D)  $\frac{f'(x)g(x) - f(x)g'(x)}{g^2(x)}$ ; E)  $\frac{f'(x)g(x) - f(x)g'(x)}{g(x)}$ ;  
 F)  $\frac{f'(x)g(x) + f(x)g'(x)}{g^2(x)}$ .

24. Berilgan  $f(x) = x^a$ ,  $a \in R$  funksiyaning  $f'(x)$  hosilasi ifodasini ko'rsating:

A)  $a \cdot x^a$ ; B) 1; D) 0; E)  $a \cdot x^{a-1}$ ; F)  $f''(x)$ .

25.  $f(x)$  funksiyalarning  $f'(x)$  hosilalari ifodasini ko'rsating:

$f(x) =$ 1) $\sin x$ ; 2) $\cos x$ ; 3) $\operatorname{tg} x$ ; 4) $\operatorname{ctg} x$ ;	$f'(x) =$ K) $\sin x$ ; L) $-\sin x$ ; M) $\cos x$ ; N) $-\frac{1}{\cos^2 x}$ ; P) $\frac{1}{\cos^2 x}$ ; Q) $-\frac{1}{\sin^2 x}$ .
---	--

A) 1K, 4P, 3M, 2N; B) 1M, 4Q, 3P, 2L;  
 D) 2L, 4K, 3Q, 1N; E) 3R, 4K, 2M, 1Q;  
 F) 4Q, 3N, 2K, 1L.

26.  $f(x)$  funksiyalarning  $f'(x)$  hosilalari ifodasini ko'rsating:

$f(x) =$ 1) $e^x$ ; 2) $a^x$ ( $a > 0$ , $a \neq 1$ );	$f'(x) =$ K) $\frac{1}{x \ln a}$ ; L) $e^x$ ; M) $\ln a^x$ ;
---	---



32. Differensiallanuvchi funksiya  $x = c$  nuqtada ekstremumga ega bo'lishi uchun  $f'(c) = 0$  bo'lishi ...

- A) yetarli;                      B) zarur va yetarli;                      D) zarur;  
E) yetarli, lekin zaruriy emas;                      F) shart emas.

33. Funksiya hosilasi mavjud bo'lmagan nuqtada funksiya ekstremumga ...

- A) ega bo'lmaydi;                      B) har vaqt ega bo'ladi;  
D) faqat minimumga ega bo'ladi;                      E) ega bo'lishi mumkin;  
F) faqat maksimumga ega bo'ladi.

34.  $f(x)$  funksiya  $c \in (a; b)$  nuqtada hosilaga ega bo'lsin. Agar  $f'(c) = 0$  va  $c$  nuqtadan chapda  $f' > 0$ , nuqtadan o'ng tomonda  $f' < 0$  bo'lsa, funksiya  $x = c$  nuqtada ... ga erishadi.

- A) lokal minimum;  
B) maksimum yoki minimum;  
D) lokal maksimum;  
E) intervaldagi eng kichik qiymat;  
F) intervaldagi eng katta qiymat.

35.  $f''(x)$  hosila  $x = c$  nuqtada 0ga teng. Bu nuqta  $f(x)$  funksiya uchun qanday nuqtadan iborat?

- A) minimum;                      B) bukilish;                      D) maksimum;  
E) ekstremum;                      F) uzilish.

36. Lagranj teoremasi: agar  $f(x)$  funksiya  $[a; b]$  kesmada uzluksiz va oraliqning ichki nuqtalarida differensiallansa, bu kesmada shunday  $x = s$  nuqta topiladiki, unda ... tenglik o'rinli bo'ladi.

- A)  $\frac{f(b)-f(a)}{b-a} = f'(c)$ ;                      B)  $\frac{f(b)+f(a)}{b+a} = f'(c)$ ;  
C)  $(f(b) - f(a))(b - a) = f'(c)$ ;                      D)  $\frac{f(x)-f(b)}{f(b)-f(a)} = f'(c)$ ;  
E)  $\frac{f(x)+f(b)}{x+a} = f'(c)$ .

37. Agar  $[a; b]$  kesmada  $f(x)$  funksiya uzluksiz va  $f'' > 0$  bo'lsa, funksiya grafigi qavariqligi bilan ... qaragan bo'ladi.

- A) yuqoriga; B) o'ngga; D) pastga; E) har tomonga; F) chapga.

38.  $(x+a)^n$  Nyuton binomi yoyilmasidagi  $(k+1)$ - hadi ... ko'rinishda bo'ladi.



- A)  $C_n^k x^n a^k$ ;      B)  $C_{n-k}^k x^{n-k} a^n$ ;      D)  $C_{n+k}^k x^k a^{n-k}$ ;  
 E)  $C_n^k x^{n-k} a^k$ ;      F)  $C_{n+k}^{n-k} x^n a^k$ .

39. Har qaysi  $f(x)$  funksiyaning  $F(x)$  boshlang'ich funksiyasini ko'rsating:

$$f(x) = \left. \begin{array}{l} \text{A) } \sqrt{3x-2}; \text{ B) } \frac{2}{\sqrt{3x-2}}, x > \frac{2}{3} \\ \text{K) } \frac{3x^2}{\sqrt{3x-2}}; \text{ L) } \frac{2}{9} \sqrt{(3x-2)^3}; \\ \text{P) } \frac{2}{3} \sqrt{3x-2}; \text{ N) } (3x-2)\sqrt{3x-2}; \end{array} \right\} F(x) =$$

- 1) AK, BL; 2) AP, BK; 3) AL, BP; 4) AN, BP; 5) AL, BN.

40.  $\int f(x) dx = F(x) + C$ ,  $C \in R$  bo'yicha har qaysi  $f(x)$  funksiyaga qaysi  $F(x)$  funksiya mos?

$$f(x) = \left. \begin{array}{l} \text{K) } \frac{1}{1+x^2}; \text{ L) } \cos x; \text{ M) } \frac{1}{\sin^2 x} \\ \text{A) } \frac{(1+x^2)^2}{2}; \text{ B) } \sin x; \\ \text{D) } -\sin x; \text{ E) } -\operatorname{tg} x; \text{ F) } -\operatorname{ctg} x; \\ \text{G) } \operatorname{arctg} x; \text{ H) } \operatorname{arcsin} x. \end{array} \right\} F(x) =$$

- 1) KA, LD, ME;      2) KG, LB, MF;      3) KA, LF, MG;  
 4) KE, LG, MH;      5) KD, LB, MB.

41.  $\int \left( 2x^2 - \frac{1}{x^2} \right) dx$  integralni toping:

- A)  $x^3 - \operatorname{arctg}(x-1) + C$ ;      B)  $\frac{2x^2 - \frac{1}{x^2}}{2} + C$ ;  
 D)  $2x^3 - \ln x^2 + C$ ;      E)  $\frac{2x^3}{3} + \frac{1}{x} + C$ ;  
 F)  $2x^3 - 2 \ln x + C$ .

42.  $\int \frac{10 \sin^2 x - 4 \cos^2 x}{\sin^2 x \cos^2 x} dx$  integralni hisoblang.

- A)  $10 \operatorname{tg} x + 4 \operatorname{ctg} x + C$ ;      B)  $6 \operatorname{tg} x - 8 \sin 2x + C$ ;  
 D)  $-\frac{10}{\cos x} + \frac{1}{\sin x} + C$ ;      E)  $10 \ln(\cos^2 x) - \frac{1}{\sin x} + C$ ;  
 F)  $6 \operatorname{ctg} x - 8 \cos 2x + C$ .

43. O'zgaruvchini almashtirishdan foydalanib hisoblang:

$$J = \int \frac{\operatorname{ctg}^3 4x dx}{\sin^2 4x} \quad \text{va} \quad K = \int \frac{dx}{x \ln x},$$

A)  $J = \frac{\operatorname{tg}^4 4x}{16}$ ,  $K = x^{\ln x}$ ;    B)  $J = -\frac{\operatorname{ctg} 4x}{16} + C$ ,  $K = \ln(\ln x) + C$ ;

D)  $J = \cos 4x$ ,  $K = \frac{1}{\ln x}$ ;    E)  $J = \sin 4x$ ,  $K = e^{-x}$ ;

F)  $J = \operatorname{tg} 4x$ ,  $K = \ln^2 x$ .

44. O'zgaruvchilarni ajratishdan foydalanib,  $y' = x^3 y^3$  differensial tenglamaning  $y(1) = -4$  boshlang'ich shartni qanoatlantiruvchi yechimini toping.

A)  $16x^3$ ;    B)  $-4x^4$ ;    D)  $-4x^{-4}$ ;    E)  $-16x^3$ ;    F)  $-16x^{-3}$ .

45.  $S_1 = \int_0^2 x^2 \sqrt{1+x^2} dx - ?$      $S_2 = \int_0^2 \frac{xdx}{\sqrt{1-x^4}} - ?$

A)  $S_1 = \frac{9}{52}$ ,  $S_2 = 2 \arcsin 2$ ;    B)  $S_1 = 52$ ,  $S_2 = \arccos 4$ ;

D)  $S_1 = \frac{26}{9}$ ,  $S_2 = 2 \arccos 4$ ;    E)  $S_1 = \frac{54}{9}$ ,  $S_2 = \sqrt{1-x^4}$ ;

F)  $S_1 = \frac{52}{9}$ ,  $S_2 = \frac{1}{2} \arcsin 4$ .

46.  $\lim_{x \rightarrow +\infty} \left( \frac{3x+15}{3x+1} \right)^{x-1}$  ni hisoblang.

A) 15;    B)  $e^{\frac{14}{3}}$ ;    D)  $\infty$ ;    E)  $e^{15}$ ;    F) 1.

47. Bir aylanada yotgan besh nuqta ustidan qancha vatar o'tkazish mumkin?

A)  $C_5^2$ ;    B)  $A_5^2$ ;    D)  $P_5$ ;    E)  $\bar{A}_5^2$ ;    F)  $\bar{C}_5^2$ .

48. Cheksiz kamayuvchi geometrik progressiyada:

$$S = \frac{3}{4}, \quad a_1 = -\frac{1}{3}; \quad a_n - ?$$

A)  $\frac{5^{n-1}}{3^{2n-1}}$ ;    B)  $\frac{9}{56}$ ;    D)  $\frac{1}{91}$ ;    E)  $\frac{3^2}{5}$ ;    F) 0.

49.  $y = x^3 - 3x$  chiziq va uning  $x_0 = -1$  absissali nuqtadagi urinmasi bilan chegaralangan shaklning yuzini toping.

- A) 5,25; B) 6,75; D) 6,25; E) 4,75; F) 5,75.

50. I integraldan har biri qaysi K ifodaga tengligini va ... nuqtalar o'rnida turgan ifodani ko'rsating.

I: A)  $\int_a^b f(x) dx$ ;

B)  $\int_b^a f(x) dx$ ;

D)  $\int_c^d f(x) dx = \dots + \int_e^d f(x) dx$ ; E)  $\int_a^b |f(x) + q(x)| dx$ ;

K: 1)  $-\int_a^b f(x) dx$ ; 2)  $\int_c^e f(x) dx$ ; 3)  $-\int_a^b f(x) dx$ ; 4) 0;

5)  $\int_a^b f(x) dx + \int_a^b q(x) dx$ ; 6)  $\int_a^b f(x) dx - \int_a^b q(x) dx$ ;

7)  $\int_c^{d-e} f(x) dx$ ; 8)  $\int_b^{2b} f(x) dx$ ; 9) C; 10)  $\int_{2a}^{2b} f(x) dx$ .

A) A3, B1, D7, E4;

B) A1, B4, D2, E5;

D) A5, B8, D6, E9;

E) A10, B9, D4, E6;

F) A8, B6, D9, E10.

51. Agar  $[a; b]$  kesmada  $f(x) \geq 0$  funksiya uchun  $k \leq f(x) \leq K$

tengsizlik o'rinli bo'lsa,  $?(b-a) \leq \int_a^b f(x) dx \leq K?$  bo'ladi. ? belgilar

o'rniga mos ifodalarni tartibi bo'yicha yozing:

A)  $(k - a), (k - b)$ ;

B)  $(K - k), (K + k)$ ;

D)  $k, (b - a)$ ;

E)  $(k - b), (k + b)$ ;

F)  $(K - a), (k + b)$ .

52.  $f(x)$  funksiya  $[a; b]$  kesmada monoton o'suvchi. Agar  $[a; b]$  kesma teng  $n$  bo'lakka bo'lingan va bo'linish nuqtalari  $a = x_0 < x_1 < \dots < x_n = b$  bo'lsa, u holda

$$\frac{?}{n} \sum_{k=0}^{n-1} ? \leq \int_a^b f(x) dx \leq \frac{?}{?} \sum_{k=1}^n ?$$

bo'ladi. ? belgilari o'rniga mos ifodalarni tartibi bilan yozing.

A)  $x_n, f(x), x_{n-1}, n-1, x_k$ ;

B)  $x_0, x_k, x_n, n-2, f(x_{k-1})$ ;

D)  $b+a, f(x_{k-1}), b+a, n-1, f(x_{k-1})$ ;

E)  $b-a, f(x_k), b-a, n, f(x_k)$ ;

F)  $x_n - x_{n-1}, f(x_k/2), x_n - x_{n-1}, 2, f(x_k/2)$ .

53. Trapetsiyalar formulasi:

$$\int_a^b f(x) dx = \frac{b-a}{n} \left( \frac{f(a)+f(b)}{2} + f(x_1) + \dots + f(x_{n-1}) \right)$$

? belgilar o'rniga mos ifodalarni kelish tartibida yozing.

A)  $b - a, b, x_{n-1};$       B)  $b + a, na, x_n;$       D)  $ab, x_{n-1}, x_{n-2};$

E)  $\sqrt{ab}, b - a, nx_0;$       F)  $\sqrt{\frac{b}{a}}, nb, nx.$

54.  $x > 0, a > 0$  uchun

Topilsin:	Javob variantlari:				
	(1)	(2)	(3)	(4)	(5)
$(\ln(ax))'$	$\frac{1}{ax}$	$\frac{1}{x}$	$\frac{a}{x}$	$\ln a + \ln x$	$e^{ax}$
$x = \frac{1}{e^2}$ da $\ln x$	2	-2	$e^2$	$e^{-2}$	1
$\lim_{x \rightarrow +\infty} \ln x$	0	$+\infty$	$-\infty$	1	$e$
$\lim_{x \rightarrow +0} \ln x$	$+\infty$	$-\infty$	-1	$e$	0

55.  $a > 0, b > 0$  uchun:

Topilsin:	Javob variantlari:				
	(1)	(2)	(3)	(4)	(5)
$a^x \cdot a^y$	$a^{xy}$	$a^x + a^y$	$a^{x+y}$	$a^{x-y}$	$a^x \cdot y$
$\frac{a^x}{a^y}$	$a^{\frac{x}{y}}$	$a^x - a^y$	$a^{x-y}$	$\sqrt{a^x}$	$\frac{a^x}{y}$
$(a^x)^y$	$a^x \cdot y$	$a^{x+y}$	$a^{xy}$	$\sqrt{a^y}$	$(a^x)^{a^y}$
$(ab)^x$	$a^x + b^x$	$ab^y$	$a^x b^y$	$a^x b$	$(a+b)^x$
$\left(\frac{a}{b}\right)^x$	$a^x - b^x$	$\frac{a}{b^x}$	$\frac{a^x}{b^x}$	$\frac{a^x}{b}$	$(a-b)^x$

56. Kombinatorika elementlari:

Asosiy formulalar	Javob variantlari:				
	(1)	(2)	(3)	(4)	(5)
$\bar{A}_m^k =$	$(m!)^k =$	$m \cdot k$	$m! \cdot k!$	$k^m$	$m^k$
$A_m^k =$	$\frac{k!}{m!}$	$\frac{m!}{k!}$	$\frac{(m-k)!}{(m+k)!}$	$\frac{(m+k)!}{(m-k)!}$	$\frac{m!}{(m-k)!}$

$P_m =$	$m!(m-1)!...1!$	$(m-1)!$	$(m+1)!$	$m(m-1)$	$m!$
$C_m^k =$	$\frac{k!}{(m+k)!}$	$\frac{k+1}{m!}$	$\frac{k-1}{m!}$	$\frac{(m+1)!}{m!(m+k)!}$	$\frac{k!}{k!(m-k)!}$
$k=k_1+\dots+k_m$ $P(k_1, k_2, \dots, k_m) =$	$k!$	$\frac{(k+1)!}{k_1!k_2!\dots k_m!}$	$\frac{k}{k_1!k_2!\dots k_m!}$	$\frac{k+1}{k_1!k_2!\dots k_m!}$	$\frac{k!}{k_1!k_2!\dots k_m!}$
$\bar{C}_m^k =$	$C_{m+1}^{k+1}$	$C_{k-m+1}^{k-1}$	$C_{k+m}^{k-1}$	$C_{k-m-1}^{k+1}$	$C_{k+m-1}^k$

### 57. Ehtimollik nazariyasi elementlari:

Qo'shish teoremlari	Javob variantlari:				
	(1)	(2)	(3)	(4)	(5)
$A \cup B = \emptyset$ uchun $P(A \cup B) =$	$P(A) \cup P(B)$	$P(A) + P(B)$	$P(A) - P(B)$	$P(A) \cap P(B)$	$P(A - B)$
$P(\bar{A}) =$	$\bar{P(A)}$	$1 - P(A)$	$1 + P(\bar{A})$	$1 - P(\bar{A})$	$1 + P(A)$

58. Bitta ehtimollik fazosidan olingan erkli  $A$  va  $B$  tasodifiy hodisalar uchun:

	Javob variantlari:				
	(1)	(2)	(3)	(4)	(5)
$P(A \cap B) =$	$P(A) - P(B)$	$P(A) + P(B)$	$P(\bar{A} \cap B)$	$P(A \cap \bar{B})$	$P(\bar{A} \cap \bar{B})$
$P(A \cap B) =$	$\frac{P(A) + P(B) - P(A \cap B)}{P(A) \cdot P(B)}$	$\frac{P(A + B) - P(A \cap B)}{P(A) \cdot P(B)}$	$\frac{P(A + B) + P(A \cap B)}{P(A) \cdot P(B)}$	$\frac{P(A) + P(B) + P(A \cap B)}{P(A) \cdot P(B)}$	$\frac{P(A) - P(B) + P(A \cap B)}{P(A) \cdot P(B)}$

59.  $X$  hodisa ro'y bergandagina  $A$  hodisaning ro'y berish ehtimolligi  $P(A|X) =$

- A)  $\frac{P(A \cup X)}{P(X)}$ ;      B)  $\frac{P(A \cap X)}{P(X)}$ ;      D)  $\frac{P(A \cup X)}{P(A)}$ ;  
 E)  $\frac{P(A \cap X)}{P(A)}$ ;      F)  $\frac{P(X)}{P(A \cap X)}$ .

60. Bernulli formulasi  $P_{m,n} =$

- A)  $C_m^n p^m q^{m-n}$ ;      B)  $C_m^n p^n q^{m-n}$ ;      D)  $C_m^n p^{m-n} q^n$ ;  
 E)  $C_n^m p^{n-m} q^m$ ;      F)  $C_n^m p^m q^{n-m}$ .

## JAVOBLAR

### I b o b

**1.9.**  $|\sin x| \leq 1$ ,  $|\cos x| \leq 1$ ,  $0 \leq 1 - \cos x \leq 2$  ekanligidan, foydalaning. **1.11.** 4)  $x = R(t - \sin t)$ ,  $y = R(1 - \cos t)$ . **1.16.** Ko'rsatma:  $BM^2 = OB^2 - OM^2 = OB^2 - (OA - MA)^2 = MA(2OA - MA)$ , bundan izlanayotgan munosabat chiqarib olinadi. **1.19.** 1) to'g'ri burchakli  $EV'S$  uchburchak bo'yicha  $r_v = r_E \sin \alpha$ , endi hisoblashlarni bajaring. **1.23.** 1)  $\sin 5x$  ning  $T_1$  asosiy davrini  $\sin(5x + 2\pi) = \sin 5(x + T_1)$  bo'yicha topamiz:  $T_1 = \frac{2\pi}{5}$ ; shu kabi

$\cos 4x$  ning asosiy davri  $T_2 = \frac{2\pi}{4}$ ;  $T_1$  va  $T_2$  ning eng kichik umumiy bo'linuvchisi javobni beradi:  $T = 2\pi$ ; 2)  $20\pi$ ; 3)  $20\pi$ . **1.24.**  $1 - \cos t$  sahmi funksiya  $t = \pi$  da 0 ga teng, juft funksiya, ixtiyoriy  $t$  da nomanfiy,  $0 \leq t \leq \pi$  da 0 dan 2 gacha monoton o'sadi,  $\pi \leq t \leq 2\pi$  da 2 dan 0 gacha monoton kamayadi;  $1 - \cos(180^\circ \pm t) = 1 + \cos t = 2 - (1 - \cos t)$ . **1.25.** 1) mumkin; 2) mumkin, chunki

$$\left(-\frac{a}{\sqrt{a^2+b^2}}\right)^2 + \left(\frac{b}{\sqrt{a^2+b^2}}\right)^2 = 1, \quad 1 - \cos t = 1 - \frac{b}{\sqrt{a^2+b^2}}. \quad \mathbf{1.28.} \quad 1) \quad m \cdot \frac{3-m^2}{2};$$

2)  $m\sqrt{2-m^2}$ . **1.31.** a) 1), 7) lar toq, 2), 3), 4) lar juft, 5), 6) lar toq ham emas, juft ham emas. **1.34.** 1)  $\frac{\sqrt{5}}{3}$ ; 2)  $-0.6$ . **1.36.** 6)  $0.5$ ; 7)  $-3$ . **1.42.** 1)  $x = \pi k$ ,

$k \in \mathbb{Z}$ ; 2)  $x = \frac{\pi}{2} + \pi k$ ,  $k \in \mathbb{Z}$ ; 3)  $\frac{\pi}{2} + 2\pi k$ ,  $k \in \mathbb{Z}$ ; 4)  $\emptyset$ ; 5)  $2\cos x - 1 \neq 0$ ,  $x \neq \pm \frac{\pi}{3} + 2\pi k$ ,  $k \in \mathbb{Z}$ . **1.43.** 1) Ko'rsatma:  $\cos 4(x + T) = \cos(4x + 2\pi)$ , bundan

$T = \pi/2$ ; 2)  $T = 4\pi$ ; 3)  $2\pi/3$ ; 4) Ko'rsatma:  $\cos(\omega(t + T) + \varphi) = \cos(\omega t + \varphi + 2\pi)$ , bundan  $\omega t + \omega T + \varphi = \omega t + \varphi + 2\pi$ ,  $T = \frac{2\pi}{\omega}$ ; 5)  $T = 2\pi/5$ ; 6)  $T = \pi$ ; 7)  $T = 1/2$ ;

8)  $T = \frac{2\pi}{\omega}$ ; 9) Yechilishi:  $\cos 4x$  bo'yicha  $T_1 = \frac{\pi}{2}$ ,  $\sin\left(5x + \frac{\pi}{4}\right)$  bo'yicha  $T_2 = \frac{2\pi}{3}$ ;  $\frac{\pi}{2}$ ,  $\frac{2\pi}{3}$  larning eng kichik umumiy bo'linuvchisi  $T$  ni beradi,  $T = 2\pi$ ;

10)  $T = 4\pi$ ; 11)  $T = 2\pi$ ; 12)  $T = 2\pi$ . **1.45.** 3)  $a^3 + 3b^2 - \frac{c^2}{3}$ ; 4) 0; 5)  $a^2$ ; 6)  $\sqrt{3}a^2 - \frac{1}{3}b^2$ . **1.46.** 1)–5) mashqlarni yechishda  $\frac{a_1 + a_2 + \dots + a_n}{n} \geq \sqrt[n]{a_1 a_2 \dots a_n}$

tengsizlikdan foydalaning, bunda  $a_1, a_2, \dots, a_n$  – musbat sonlar. Masalan,  $\sqrt{a^2 \cdot 1} = a$ , bundan  $\frac{a^2+1}{2a} \geq 1$ . Bunday qiymatlarni tangens va kotangens qabul

qila oladi va faqat  $a = 1$  bo'lgandagina  $\frac{a^2+1}{2a} = 1$  bo'ladi va berilgan qiymatni sinus va kosinus ham qabul qiladi. **1.48.**  $\cos \alpha = \frac{a^2-b^2}{a^2+b^2}$ ,  $\operatorname{tg} \alpha = \frac{2ab}{a^2-b^2}$ . **1.49.** –2.

1.52. 1) 0; 3) 0; 4) 0. 1.56.  $\cos^4 x + \sin^4 x = (\cos^2 x + \sin^2 x)^2 - 2\cos^2 x \sin^2 x = 1 - 2\cos^2 x \sin^2 x$ . Ikkinchi tomondan  $\cos^6 x + \sin^6 x = (\cos^2 x)^3 + (\sin^2 x)^3 = \dots = 1 - 3\cos^2 x \sin^2 x = q$ . Bundan  $\cos^2 x \sin^2 x = \frac{1-q}{3}$ . Javob:  $\cos^4 x + \sin^4 x = 1 - 2 \cdot \frac{1-q}{3} = \frac{1+2q}{3}$ .

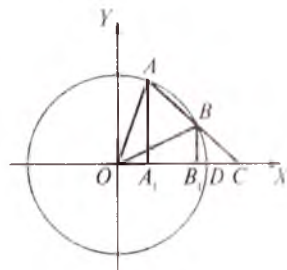

1.54-rasm.

1.57. Agar  $0 < x < \frac{\pi}{2}$ ,  $h > 0$ ,  $x + h < \frac{\pi}{2}$  deb qo`-

yilsa, masalani hal qilish uchun  $\frac{\sin(x+h)}{x+h} < \frac{\sin x}{x}$  bo`lishini isbot qilish yetarli (geometrik isbotida 1-§, 1-banddagi ma`lumotlarga tayanish mumkin). Markazi koordinatalar boshida joylashtirilgan birlik aylana da  $A(x+h)$  va  $B(x)$  nuqtalar belgilangan bo`lsin (1.54-rasm).

$$\text{O}AB = h, \text{O}BD = x, \frac{\sin(x+h)}{\sin x} = \frac{AA_1}{BB_1} = \frac{AC}{BC} = \frac{BC+AB}{BC} =$$

$$= 1 + \frac{AB}{BC} < 1 + \frac{h}{x} = \frac{x+h}{x}. \text{ Bundan } \frac{\sin(x+h)}{x+h} < \frac{\sin x}{x}. \text{ 1.63. Ko`rsatma: 1), 3),$$

4) larda  $y = \cos x$  funksiya grafigini almashtirishdan, 2), 5), 6), 9) larda  $y = \sin x$  funksiya grafigini almashtirishdan, 7), 8) larda esa  $\{\alpha\}$ ,  $\{\alpha\}$  larning ta`rifidan foydalaning. 1.64. Ko`rsatma: 1), 2), 4), 5) larda  $y = \cos x$  funksiya grafigini almashtirishdan, 3) da  $y = \sin x$  funksiya grafigini almashtirishdan foydalaning. 1.69. Ko`rsatma:  $y = \text{tg} x$ ,  $y = \text{ctg} x$  funksiyalarning grafigini almashtirishdan va  $|\alpha|$ ,  $|\alpha|$ ,  $\{\alpha\}$  larning ta`rifidan o`z o`rnida foydalaning. 1.70. 1)  $\frac{\sin \pi}{12} = \sin\left(\frac{\pi}{2} - \frac{5\pi}{12}\right) = \cos \frac{5\pi}{12} =$

$$= \cos\left(\frac{\pi}{4} + \frac{\pi}{6}\right) = \frac{\sqrt{2}}{2} \cdot \frac{\sqrt{3}}{2} - \frac{\sqrt{2}}{2} \cdot \frac{1}{2} = \frac{\sqrt{2}(\sqrt{3}-1)}{4}; 2) -\frac{1}{2}; 3) -\frac{\sqrt{2}}{2}; 4) -\frac{\sqrt{3}}{2}. \text{ 1.75.}$$

Ko`rsatma: 1) Funksiyalar ifodasini  $y = \cos\left(x - \frac{x}{2}\right)$  yoki  $y = \cos \frac{x}{2}$  ko`rinishiga keltiring,  $\cos \frac{x+T}{2} = \cos\left(\frac{x}{2} + 2\pi\right)$  bo`yicha  $T = 4\pi$ . 1.84.  $f_1(x)$  va  $f_2(x)$  chiziq'larga ularning  $M(x_0; y_0)$  kesishish nuqtasi orqali o`tkazilgan  $l_1$  va  $l_2$  urinmalar  $OX$  o`qining musbat yo`nalishi bilan  $\alpha_1$  va  $\alpha_2$  burchak tashkil qilsin (1.55-rasm). Kesishuvda hosil bo`ladigan  $\beta$  burchak  $\beta = \alpha_2 - \alpha_1$  bo`ladi.

$\text{tg} \beta = \text{tg}(\alpha_2 - \alpha_1) = \frac{k_2 - k_1}{1 + k_1 k_2}$  bo`ladi, bunda  $k_1 = \text{tg} \alpha_1$ ,  $k_2 = \text{tg} \alpha_2$  urinuvchi to`g`ri

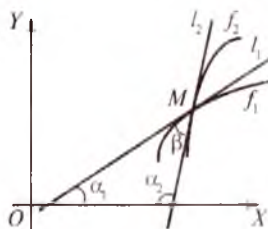

1.55-rasm.

chiziq'larning burchak koeffitsiyentlari. 1)  $\frac{3}{4}$ ; 2)

$$\frac{10\sqrt{2}}{13}. \text{ 1.85. } \text{tg} A = x \text{ deb belgilaylik. U holda}$$

$$\text{tg} B = 2x, \text{tg} C = 3x; \text{tg} C = \text{tg}(\pi - (A + B)) = -\text{tg}(A + B) =$$

$$= 3x \text{ yoki } -3x = \frac{x+2x}{1-x \cdot 2x}. \text{ Tenglamani yechib, } x_1 = 0,$$

$x_2 = 1$ ,  $x_3 = -1$  ni topamiz. Uchburchak burchaklari 0 ga, yoki hammalari o`tmas, yoki 180° ga teng bo`lishlari mumkin emas. Shunga ko`ra masala

shartini faqat  $x = 1$  qanoatlantiradi. Javob:  $\operatorname{tg} A = 1$ ,  $\operatorname{tg} B = 2$ ,  $\operatorname{tg} C = 3$ ,

$$\sin A = \frac{\sqrt{2}}{2}, \quad \sin B = \frac{2\sqrt{5}}{5}, \quad \sin C = \frac{3\sqrt{10}}{10}. \quad \mathbf{1.88.} \quad 1) \frac{\sqrt{6}}{2}; \quad 2) \frac{\sqrt{3}}{1-\sqrt{3}}. \quad \mathbf{1.96.} \quad 10) \operatorname{tg} 55^\circ.$$

$$\operatorname{tg} 65^\circ = \operatorname{tg}(60^\circ - 5^\circ) \cdot \operatorname{tg}(60^\circ + 5^\circ) = \frac{\operatorname{tg} 60^\circ - \operatorname{tg} 5^\circ}{1 + \operatorname{tg} 60^\circ \operatorname{tg} 5^\circ} \cdot \frac{\operatorname{tg} 60^\circ + \operatorname{tg} 5^\circ}{1 - \operatorname{tg} 60^\circ \operatorname{tg} 5^\circ} = \frac{3 - \operatorname{tg}^2 5^\circ}{1 - 3 \operatorname{tg}^2 5^\circ}, \quad \operatorname{tg} 75^\circ =$$

$$= \operatorname{ctg} 15^\circ = \operatorname{ctg} 3 \cdot 5^\circ = \frac{\operatorname{ctg}^3 5^\circ - 3 \operatorname{ctg} 5^\circ}{3 \operatorname{ctg} 5^\circ - 1} = \frac{1 - 3 \operatorname{tg}^2 5^\circ}{3 \operatorname{tg} 5^\circ - \operatorname{tg}^3 5^\circ}; \quad \operatorname{tg} 55^\circ \cdot \operatorname{tg} 65^\circ \cdot \operatorname{tg} 75^\circ = \frac{1}{\operatorname{tg} 5^\circ} =$$

$$= \operatorname{ctg} 5^\circ = \operatorname{tg} 85^\circ. \quad \mathbf{1.97.} \quad 1) \frac{1}{128}; \quad 2) -1; \quad 3) 3 \operatorname{tg} 2\alpha; \quad 4) 2 \cos \alpha; \quad 6) \frac{\sin 7\alpha}{\sin \alpha}; \quad 7) 1; \quad 8)$$

$$\cos\left(\frac{\pi}{4} - 2\alpha\right). \quad \mathbf{1.99.} \quad \sin 15^\circ = \frac{\sqrt{2}-\sqrt{3}}{2}, \quad \sin 18^\circ = \frac{\sqrt{5}-1}{4}. \quad \mathbf{1.100.} \quad 1) |\sin 3\alpha|; \quad 2) \sqrt{2} |\cos 5x|;$$

$$3) 1; \quad 4) \operatorname{ctg} 2\alpha; \quad 5) \left| \operatorname{tg} \frac{\alpha}{2} \right|. \quad \mathbf{1.101.} \quad 5) \text{Ko'rsatma: } \sin^2 \alpha + \cos^4 \alpha = (\sin^2 \alpha + \cos^2 \alpha)^2 -$$

$$- 2 \sin^2 \alpha \cos^2 \alpha \text{ dan foydalaning. } \mathbf{1.107.} \quad 1) \frac{1}{8}; \quad 2) \text{Yechilishi: } \frac{\sin 35^\circ}{\cos 35^\circ} \cdot \frac{\sin 55^\circ}{\cos 55^\circ} =$$

$$= \frac{\frac{1}{2}(\cos 20^\circ - \cos 90^\circ)}{\frac{1}{2}(\cos 20^\circ + \cos 90^\circ)} = 1; \quad 3) 1 - \sqrt{3}; \quad 4) 0,25; \quad 5) \frac{1}{16}. \quad \text{Ko'rsatma: dastlab}$$

$$\cos 9^\circ \cos 81^\circ \text{ va } \cos 27^\circ \cos 63^\circ \text{ ko'paytmalarni yig'indiga keltiring. } \mathbf{1.109.} \quad 5)$$

$$\frac{1}{\sqrt{3}} = \operatorname{ctg} 60^\circ = \operatorname{ctg}(3 \cdot 20^\circ) = \frac{\operatorname{ctg}^3 20^\circ - 3 \operatorname{ctg} 20^\circ}{3 \operatorname{ctg}^2 20^\circ - 1} \text{ yoki kvadratga ko'tarilsa, } \operatorname{ctg}^6 20^\circ -$$

$$- 6 \operatorname{ctg}^4 20^\circ + 9 \operatorname{ctg}^2 20^\circ = 3 \operatorname{ctg}^4 20^\circ - 2 \operatorname{ctg}^2 20^\circ + \frac{1}{3} \text{ va hokazo, } 6) \cos 9^\circ \cos 81^\circ =$$

$$= \frac{1}{2} (\cos 90^\circ + \cos 72^\circ) = \frac{1}{2} \cos 72^\circ, \text{ shu kabi } \cos 27^\circ \cos 63^\circ = \frac{1}{2} \cos 36^\circ. \text{ U holda}$$

$$\cos 9^\circ \cos 27^\circ \cos 63^\circ \cos 81^\circ = \frac{1}{4} \cos 72^\circ \cos 36^\circ = \frac{1}{4} \cos 72^\circ \cdot \frac{2 \sin 36^\circ}{2 \sin 36^\circ} \cdot \cos 36^\circ =$$

$$= \frac{\sin 144^\circ}{16 \sin 36^\circ} = \frac{1}{16}, \quad \cos 12^\circ \cos 24^\circ \cos 48^\circ \cos 96^\circ = \dots = \frac{1}{16}; \quad 7) \text{ tenglikning chap qis-$$

$$\text{mini } 2 \sin \frac{\alpha}{2} \text{ ga ko'paytiramiz va bo'lamiz: } \frac{1}{2 \sin \frac{\alpha}{2}} \left( \sin \alpha \cdot 2 \sin \frac{\alpha}{2} + \sin 2\alpha \cdot 2 \sin \frac{\alpha}{2} + \right.$$

$$\left. + \dots + \sin n\alpha \cdot 2 \sin \frac{\alpha}{2} \right) = \frac{1}{2 \sin \frac{\alpha}{2}} \left( \left( \cos \frac{\alpha}{2} - \cos \frac{3\alpha}{2} \right) + \left( \cos \frac{3\alpha}{2} - \cos \frac{5\alpha}{2} \right) + \dots + \left( \cos \frac{2n-1}{2} \alpha - \cos \frac{2n+1}{2} \alpha \right) \right) =$$

$$= \frac{1}{2 \sin \frac{\alpha}{2}} \left( \cos \frac{\alpha}{2} - \cos \frac{2n+1}{2} \alpha \right) = \dots. \quad \mathbf{1.110.} \quad 1) \frac{\cos n\alpha - 1 + 2n \sin \frac{\alpha}{2} \sin \frac{2n+1}{2} \alpha}{4 \sin^2 \frac{\alpha}{2}}; \quad 2) \frac{2 \sin 9\alpha}{\sin 2\alpha \cos 10\alpha}.$$

$$\mathbf{1.111.} \quad 1) 5 \sin(5t + \alpha), \quad \alpha = \arccos 0,6; \quad 2) 12 \sin(3t + \alpha), \quad \alpha = \arccos \frac{11}{12} - \frac{\pi}{6}; \quad 3)$$

$$13 \sin(2t + \alpha), \quad \alpha = \arccos \frac{12}{13} + \frac{\pi}{3}. \quad \mathbf{1.115.} \quad 1) \varphi_0 - t = 0 \text{ vaqt momentidagi bosh-$$

$$\text{lang'ich faza, } X = X_0 \cos \varphi \text{ yoki } X = X_0 \cos \omega t, \quad Y = Y_0 \sin \varphi \text{ yoki } Y = Y_0 \sin \omega t;$$



3)  $X = X_0 \cos(\omega t + \varphi_0)$ ,  $Y = Y_0 \sin(\omega t + \varphi_0)$ . **1.116.** 7)  $\sin x = \frac{7}{5} > 1$  bo'lgani uchun

tenglamaning yechimi yo'q. **1.119.** 4)  $3\pi - 10$ . **1.122.** 1)  $\pm \frac{3\pi}{4} + 2k\pi$ ; 8)  $2 - \frac{\pi}{2}$ .

**1.125.** 4) Yechimi yo'q. **1.127.** 3)  $\arctg 0,2 + k\pi$ ,  $k \in \mathbb{Z}$ . **1.129.** 1)  $\sqrt{3}$ ; 5)

$\operatorname{tg}\left(\arctg\left(-\frac{2}{3}\right)\right) = \operatorname{tg}\left(\pi - \arctg\frac{2}{3}\right) = -\operatorname{tg}\left(\arctg\frac{2}{3}\right) = -\frac{1}{\operatorname{ctg}\left(\arctg\frac{2}{3}\right)} = -\frac{3}{2}$ . **1.133.**

1)  $\frac{1}{10}(-1)^{k+1} \frac{\pi}{3} + \frac{k\pi}{10}$ ,  $k \in \mathbb{Z}$ ; 2)  $\frac{1}{10}\left(\pm \frac{\pi}{6} + 2k\pi\right)$ ,  $k \in \mathbb{Z}$ ; 3)  $\frac{1}{10}\left(\frac{\pi}{3} + k\pi\right)$ ,  $k \in \mathbb{Z}$ ; 5)

$-5^\circ + 60^\circ k$ ,  $k \in \mathbb{Z}$ ; 9)  $22^\circ 30' \pm 30' + 180^\circ k$ ,  $k \in \mathbb{Z}$ ; 11)  $\emptyset$ . **1.134.** Ko'rsatma: 3)

$5x = -\frac{x}{3} + \pi k$ ,  $k \in \mathbb{Z}$ ; 6)  $3x = \frac{\pi}{2} + 5x + \pi k$ ,  $k \in \mathbb{Z}$ ; 8)  $\operatorname{tg}(5\pi - x) = \operatorname{tg}(\pi - x) = -\operatorname{tg}x$ ;

$-\operatorname{ctg}\left(2x + \frac{\pi}{6}\right) = \operatorname{tg}\left(\frac{2\pi}{3} + 2x\right)$ ; 12)  $\sqrt{x} = \frac{\pi}{2} - 2x + \pi k$ ,  $k \in \mathbb{Z}$ ; ...; 13) kvadrat teng-

lamani yeching; 15)  $x^2 = (-1)^k(-3x^2) + \pi k$ ,  $k \in \mathbb{Z}$ ; 17)  $\sqrt{2}(\sin x + \cos x)\left(1 - \frac{1}{2}\sin 2x\right) =$

$= \sin 2x$ . **1.136.** 1)  $(\sin x - \cos x)^2 = 0$ , ...; 3)  $\operatorname{tg} 2x = 3$ ;  $\operatorname{tg} 2x = 7$ ; ... 8)  $2\operatorname{tg}^2 x - 6\operatorname{tg} x - 23 = 0$ ; 10)  $\cos^4 x - \sin^4 x = (\cos^2 x - \sin^2 x)(\cos^2 x + \sin^2 x) = \cos^2 x - \sin^2 x = \dots$ ; 11)

$x = \frac{\pi}{4} + \frac{n\pi}{2}$ ,  $n \in \mathbb{Z}$ ; 12)  $x = \frac{n\pi}{2}$ ,  $n \in \mathbb{Z}$ . **1.137.** 1)  $\frac{\pi}{2} + k\pi$ ,  $k \in \mathbb{Z}$ ; 2)  $\sin x = 1$ ,

$\cos^2 x = \frac{1}{3}$ ; 3)  $x_1 = 2\pi k$ ,  $k \in \mathbb{Z}$ ,  $x_2 = \pm \frac{\pi}{4} + 2\pi k$ ,  $k \in \mathbb{Z}$ ,  $x_3 = \pm \frac{3\pi}{4} + 2\pi k$ ,  $k \in \mathbb{Z}$ ; 4)  $\emptyset$ ;

5)  $\frac{\pi}{2} + \pi k$ ,  $k \in \mathbb{Z}$ . **1.138.** 2)  $x_1 = 2\pi k$ ,  $k \in \mathbb{Z}$ ,  $x_2 = \pm \frac{\pi}{6} + 2\pi k$ ,  $k \in \mathbb{Z}$ ,  $x_3 = \pm \frac{5\pi}{6} + 2\pi k$ ,

$k \in \mathbb{Z}$ ; 3)  $\frac{\pi}{4} + \pi k$ ,  $\arctg 3 + \pi k$ ,  $k \in \mathbb{Z}$ ; 4)  $\frac{\pi}{4} + \pi k$ ,  $\arctg 2 + \pi k$ ,  $k \in \mathbb{Z}$ ; 5)  $\frac{\pi}{4} + \frac{\pi}{2} k$ ,

$k \in \mathbb{Z}$ ; 7) berilgan tenglama  $\cos 5x + \cos 7x = \pm(\sin 5x + \sin 7x)$  tenglamaga teng kuchli; 8) tenglamani  $\sin^2 4x - 2\sin 4x \cos^4 x + \cos^8 x = \cos^8 x - \cos^2 x$  yoki  $(\sin 4x - \cos^4 x)^2 = -\cos^2 x(1 - \cos^6 x)$  ko'rinishda qaytadan yozamiz.  $(\sin 4x - \cos^4 x)^2 \geq 0$ ,  $-\cos^2 x(1 - \cos^6 x) \leq 0$  bo'lganiga ko'ra tenglik  $\cos^2 x(1 - \cos^6 x) = 0$  bo'lganda o'rinni bo'ladi. Bu tenglama ikki tenglamaga ajraladi:  $\cos x = 0$ ,  $1 - \cos^6 x = 0$ . Javob:

$x = \frac{\pi}{2} + \pi k$ ,  $k = 0, \pm 1, \pm 2, \dots$ ; 9) Yechilishi:  $\sin 2x = 1$  tenglamani qanoatlantirmoqda. Shunga ko'ra  $(\sin 2x - 1)(\sin^2 2x - 4\sin 2x - 4) = 0 \Rightarrow$

$\Rightarrow \begin{cases} \sin 2x = 1, \\ \sin 2x = 2(1 \pm \sqrt{2}) \end{cases} \Rightarrow \begin{cases} \sin 2x = 1, \\ 1 + \sqrt{2} > 1 \text{ bo'lmogda} \Rightarrow \left\{ x_1 = 45^\circ + 180^\circ k, \right. \\ \left. \sin 2x = 2(1 - \sqrt{2}) \right\} \end{cases}$

$x_2 = \frac{1}{2}(-1)^k \arcsin 2(1 - \sqrt{2}) + \frac{\pi}{2} k$ ,  $k \in \mathbb{Z}$ . **1.139.** 1)  $x = -\frac{\pi}{4} + n\pi$ ; 2)  $x = \frac{\pi}{2} + 2n\pi$ ;

3)  $x = \frac{\pi}{8} + \frac{\pi}{2} n$ ,  $n \in \mathbb{Z}$ . **1.140.** 1)  $\emptyset$ ; 2)  $x = \frac{\pi}{2} + \pi k$ ; 3)  $x = -\frac{\pi}{6} + \frac{2\pi k}{3}$ ,  $n, k \in \mathbb{Z}$ ;

$x = \frac{\pi}{2} + n\pi$ ,  $n \in \mathbb{Z}$ . **1.141.** 1)  $x = -\arccos\left(\frac{12}{13}\right) + \frac{\pi}{2} + 2n\pi$ ; 2)  $x = \frac{\pi}{4} + 2n\pi$ ,  $n \in \mathbb{Z}$ ;

3)  $x = (-1)^k \frac{\pi}{6} + \frac{\pi}{6} + \pi k, k \in Z$ . **1.143.** 12) Ko'rsatma: ildiz ostidagi ifodalar soddalashtirilsin. Natijada:  $\sqrt{(2\sin x + 1)^2} + \sqrt{(2\sin x - 1)^2} = 2, |\sin x + 1| + |\sin x - 1| = 2$ . Tenglama faqat  $|\sin x| \leq \frac{1}{2}$  da o'rinni. Undan:  $-\frac{\pi}{6} + \pi n \leq x \leq \frac{\pi}{6} + \pi n, n = 0, \pm 1, \pm 2, \dots$  **1.144.** Yechish. Tenglamani  $\sin x = 2x - 2$  ko'rinishda yozib olamiz va  $y = \sin x, y = 2x - 2$  funksiyalar grafiklarini bitta koordinatalar tekisligida yasaymiz (I.56-rasm).

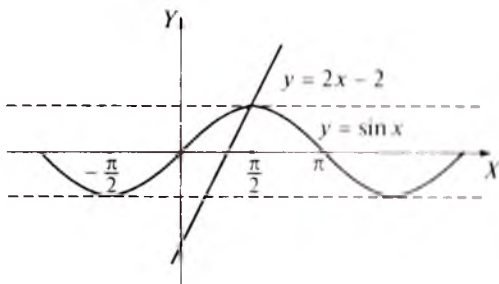

I.56-rasm.

Grafiklar bitta nuqtada kesishadi. Bu nuqtaning abssissasi berilgan tenglamaning yagona ildizidir. Grafiklar kesishish nuqtasining abssissasi  $\approx 1,5$  ga teng. Shunday qilib,  $x \approx 1,5$ . **1.145.** 1)  $x = \frac{\pi}{6} + 2\pi n, n \in Z,$

$$y = \frac{\pi}{6} - 2\pi n, n \in Z; 2) x = -\frac{\pi}{6} + \pi(k + l), y = \frac{2\pi}{3} + \pi(k - l), k, l \in Z; 3)$$

$$x = \pm \frac{\pi}{6} + \pi(m + n), y = \pm \frac{\pi}{6} + \pi(n - m), m, n \in Z; 4) \emptyset. \mathbf{1.146.} 1) \operatorname{ctg} 2\alpha = \frac{\operatorname{ctg}^2 \alpha - 1}{2 \operatorname{ctg} \alpha} < < \frac{\operatorname{ctg}^2 \alpha}{2 \operatorname{ctg} \alpha} = \frac{1}{2} \operatorname{ctg} \alpha; 2) \sin^6 \alpha - \sin^3 \alpha + 0,5^2 = (\sin^2 \alpha - 0,5)^2 \geq 0; 3) \text{Har doim}$$

$2 + \cos \alpha > 0$ . Tengsizlik  $-\sqrt{3}(2 + \cos \alpha) \leq 3 \sin \alpha \leq \sqrt{3}(2 + \cos \alpha)$ , bundan  $3|\sin \alpha| \leq 2 + \cos \alpha$ , yoki  $4 \cos^2 \alpha + 4 \cos \alpha + 1 \geq 0$ , yoki  $(2 \cos \alpha + 1)^2 \geq 0$ ; 4)

$$\cos A \cdot \cos B \cdot \cos C = \frac{1}{2} [\cos(A - B) + \cos(A + B)] \cos C = \frac{1}{2} [\cos(A - B) - \cos C] \cos C =$$

$$= -\frac{1}{2} [\cos^2 C - \cos(A - B) \cos C] = \frac{1}{8} \cos^2(A - B) - \frac{1}{2} \left[ \cos C - \frac{\cos(A - B)}{2} \right]^2 \leq$$

$$\leq \frac{1}{8} \cos^2(A - B) \leq \frac{1}{8}; 9) |a \sin x + b \cos x| \leq \sqrt{a^2 + b^2} \text{ bo'lganiga ko'ra } |3 \sin x -$$

$-4 \cos x| \leq \sqrt{3^2 + 4^2} = 5$ ; 10)  $\sin \alpha > \sin \alpha \cos \beta, \sin \beta > \sin \beta \cos \alpha$  ekani ma'lum. Ular hadlab qo'shilsa:  $\sin \alpha + \sin \beta > \sin \alpha \cos \beta + \cos \alpha \sin \beta = \sin(\alpha + \beta)$ ; 11) oldingi misolga asoslanilsa,  $2 \sin \alpha = \sin(\alpha + \beta) < \sin \alpha + \sin \beta, \sin \alpha < \sin \beta$ , demak,  $\alpha < \beta$ . **1.153.** 1) 0,2376; 2) 0,9832; 3) 0,1510; 4) 0,5150, darajalarni radianlarga o'tkazing. **1.157.** 1)  $\operatorname{tg}(\operatorname{arctg} 3) = 3$  bo'lishini bilamiz. Lekin

$\operatorname{arctg}(\operatorname{tg} 3) = 3$  deyilishi qo'pol xatolik bo'ladi, chunki  $-\frac{\pi}{2} < \operatorname{arctg} m < \frac{\pi}{2}$ .

Demak,  $\arctg(\operatorname{tg}3) \in \left(-\frac{\pi}{2}; \frac{\pi}{2}\right)$  bo'lishi kerak:  $\operatorname{tg}\alpha = \operatorname{tg}(\arctg(\operatorname{tg}3)) = \operatorname{tg}3$ . Tangenslar-ning tenglik shartiga ko'ra  $\alpha = 3 + \pi k$ . Lekin shart bo'yicha  $-\frac{\pi}{2} < 3 + k\pi < \frac{\pi}{2}$  yoki  $\frac{\frac{\pi}{2}-3}{\pi} < k < \frac{\frac{\pi}{2}+3}{\pi}$  yoki  $-1,43... < k < -0,45...$ , bundan  $k = -1$ . Demak,  $\arctg(\operatorname{tg}3) = 3 - \pi$ ; 2)  $\alpha = \arcsin(\sin 4)$ ,  $\sin\alpha = \sin 4$ ,  $\alpha = (-1)^k \cdot 4 + \pi k$ ,  $-\frac{\pi}{2} \leq (-1)^k \cdot 4 + k\pi \leq \frac{\pi}{2}$ , bundan  $k = 1$ . Demak,  $\alpha = -4 + \pi$ ; 5)  $\arccos\left[\cos\left(\frac{\pi}{2} + \frac{\pi}{8}\right)\right] = \arccos\left[\cos\frac{5\pi}{8}\right] = \frac{5\pi}{8} \in [0; \pi]$ ; 6)  $\arcsin\left[\cos\left(4\pi + \frac{2}{7}\pi\right)\right] = \arcsin\left[\cos\frac{2}{7}\pi\right] = \arcsin\left[\sin\left(\frac{\pi}{2} - \frac{2}{7}\pi\right)\right] = \arcsin\left(\sin\frac{3\pi}{14}\right) = \frac{3\pi}{14} \in \left[-\frac{\pi}{2} \leq x \leq \frac{\pi}{2}\right]$ ; 7)  $\arctg\left[\operatorname{tg}\left(\frac{\pi}{2} - \frac{3\pi}{7}\right)\right] = \arctg\left[\operatorname{tg}\frac{\pi}{14}\right] = \frac{\pi}{14}$ ; 9)  $\cos 2\alpha = \cos^2\alpha - 1$ ,  $\alpha \in \left(-\frac{\pi}{2}; \frac{\pi}{2}\right)$  bo'yicha ayniyat  $2\cos^2(\arccos x) - 1 = 2x^2 - 1$ ; 10)  $\cos 3\alpha = \cos\alpha(4\cos^2\alpha - 3)$  bo'yicha:  $\cos(\arccos x) \cdot (4\cos^2(\arccos x) - 3) = x(4x^2 - 3)$ ,  $-1 \leq x \leq 1$ ; 12) Ko'rsatma:  $\arcsin(\sin 100) = (-1)^k(k\pi - 100)$ , bunda  $k$  bunday aniqlandi:  $-\frac{\pi}{2} \leq k\pi - 100 \leq \frac{\pi}{2}$ ,  $\frac{100}{\pi} - \frac{1}{2} \leq k \leq \frac{100}{\pi} + \frac{1}{2}$ ,  $31,3 \leq k \leq 32,3$ ,  $k = 32$ .  $\arcsin(\sin 100) = 32\pi - 100$ ; 13)  $\sin 3\alpha = 3\sin\alpha - 4\sin^3\alpha$ , bunda  $\alpha = \arcsin x$ , bundan  $\sin(3\arcsin x) = 3x - 4x^3$ . **1.158.** 1)  $\frac{\sqrt{2}}{2}$ ; 2) 0; 3)  $\sqrt{3}, 1$ ; 7) Ko'rsatma:  $y = 2\arcsin x$  almashtirish kiritilgandan so'ng  $\sin y + \cos y = 1$ ;  $\sqrt{2}\left(\frac{\sqrt{2}}{2}\sin y + \frac{\sqrt{2}}{2}\cos y\right) = 1 \Rightarrow \sqrt{2}\sin\left(y + \frac{\pi}{4}\right) = 1$ , bundan  $y = k\pi + (-1)^k \cdot \frac{\pi}{4} - \frac{\pi}{4}$ . Ikki holni qarang:  $k = 2m$ ,  $k = 2m - 1$ . 8) Ko'rsatma:  $\arccos x = \frac{5\pi}{2} + 10k\pi$ ,  $x = \cos\left(\frac{5\pi}{2} + 10k\pi\right) = 0$ ,  $k = 0, \pm 1, \pm 2, \dots$ ;  $x = 0$ . **1.159.** 1)  $-\frac{\sqrt{2}}{2} \leq x^2 - 4x \leq \frac{\sqrt{3}}{2} \dots$ ; 2)  $\left[-\frac{\pi}{12}; -\frac{\arctg 0,5}{3}\right] \cup \left[\frac{\arctg 2,5}{3}; \frac{\arctg 3}{3}\right]$ ; 3)  $\sin(\arcsin x - \arccos x) > \sin 0 = 0$  ni isbot qilish kerak.  $\sin(\arcsin x - \arccos x) = \sin(\arcsin x) \cdot \cos(\arccos x) - \sin(\arccos x)\cos(\arcsin x) = x^2 - (\sqrt{1-x^2})^2 = 2x^2 - 1 > 0 \Rightarrow |x| > \frac{1}{\sqrt{2}}$  yoki  $x < -\frac{\sqrt{2}}{2}$ ,  $x > \frac{\sqrt{2}}{2}$ , lekin tengsizlik  $|x| \leq 1$  da ma'noga ega. Demak,  $\frac{\sqrt{2}}{2} < x \leq 1$ . 4)  $\left(-\frac{\sqrt{2}}{2}; \frac{\sqrt{2}}{2}\right)$ . **1.160.** 2)  $6(\sqrt{3} + 1)$ .

## I I b o b

**2.1.**  $\emptyset$ . **2.2.**  $x=0$ . **2.3.**  $\emptyset$ . **2.4.**  $x=1$ . **2.5.**  $x = \pm \frac{\pi}{3} + 2\pi n$ ,  $y = \pm \frac{\pi}{3} + 2(n-k)\pi$ ,  $n, k \in \mathbb{Z}$ .

Ko'rsatma: tenglamani  $4\cos^2 \frac{x+y}{2} - 4\cos \frac{x-y}{2} \cdot \cos \frac{x+y}{2} + 1 = 0$  ko'rinishga

keltirib, chap tomonda to'la kvadrat ajrating. **2.6.**  $x = \frac{\pi}{4} + \frac{k\pi}{2}$ ,  $y = \frac{\pi}{2} + 2\pi n$ ,

$n, k \in Z$ . Ko'rsatma: tenglamani  $\sin y = 2\left(1 - \frac{1}{2}\sin^2 2x\right) \cdot \left(1 + \frac{16}{\sin^4 2x}\right) - 16$  ko'ri-

nishga keltiring va  $-1 \leq \sin y \leq 1$  ekanligidan foydalanib,  $\begin{cases} \sin^2 2x = 1, \\ \sin y = 1 \end{cases}$  siste-

mani hosil qiling. **2.7.**  $x = \frac{\pi}{4}(2k + 1)$ . Ko'rsatma: tenglamani  $(\operatorname{tg}^2 x - \operatorname{tg}^2 y) +$

$+ 2(\operatorname{tg} x \cdot \operatorname{tg} y - \operatorname{ctg} x \cdot \operatorname{ctg} y)^2 + 1 = \sin^2(x + y)$  ko'rinishga keltiring. **2.8.**  $x = 2$ .

Ko'rsatma: tenglamani  $x \cdot 2^x = 8$  ko'rinishga keltiring. **2.9.**  $x_1 = 0$ ,  $x_2 = 2$ .

Ko'rsatma: tenglamani  $(x - 2)(2^x + x - 1) = 0$  ko'rinishga keltiring. **2.10.**

$x = k\pi$ ,  $y = 1$ ,  $k \in Z$ . **2.11.**  $\emptyset$ . **2.12.**  $x = \frac{\pi}{2} + k\pi$ ,  $x = 2k\pi$ ,  $k \in Z$ . **2.13.**  $\emptyset$ . **2.14.**

$x = \frac{5\pi}{4} + 2k\pi$ ,  $k \in Z$ . **2.15.**  $\emptyset$ . **2.16.**  $x = 1$ ,  $y = 0$ . **2.17.**  $x = 1$ ,  $y = 0$ . **2.18.**

$2k\pi < x < \frac{\pi}{2} + 2k\pi$ ,  $k \in Z$ . **2.19.**  $(-\infty; -1] \cup [1; +\infty)$ . Ko'rsatma: tengsizlik-

ning aniqlanish sohasini toping va unda  $\sqrt{x^2 - 1} \geq 0$  bo'lishini e'tiborga oling.

**2.20.**  $[1; +\infty)$ . **2.21.**  $(-\infty; -1] \cup [1; +\infty)$ . **2.22.**  $(-\infty; 1]$ . **2.23.**  $[1; +\infty)$ .

Ko'rsatma:  $x \geq 1$  bo'lsa,  $\sqrt{x} \leq x$  va  $2^x \geq 2$  bo'ladi. **2.24.**  $(-\infty; 1]$ . Ko'rsatma:

$x \leq 1$  bo'lganda  $2^{\sqrt{1-x}} \geq 2^0 = 1 \geq x$  bo'ladi. **2.26.**  $[1; 2)$ . **2.27.**  $x = \frac{\pi}{2} + 2\pi k$ ,  $k = 7, 8,$

$9, \dots$ . Yechilishi. Tengsizlik  $\sin x = 1$  bo'ladigan  $x$  larda aniqlangan, ya'ni

tengsizlikning aniqlanish sohasi  $x = \frac{\pi}{2} + 2\pi k$ ,  $k \in Z$  lardan tashkil topadi.

Bu  $x$  lar ichidan tengsizlikning yechimi bo'ladiganlarini bevosita qo'yib

ko'rish bilan aniqlaymiz:  $0 < \left(\frac{\pi}{2} + 2\pi k\right) - 13\pi$ ,  $k \in Z$ . Bundan,  $k \geq 7$  ekani

kelib chiqadi. **2.28.**  $(-\infty; -2) \cup (2; +\infty)$ . **2.29.**  $x = -1$ . **2.30.**  $x = 2$ . **2.32.**  $(-\infty; +\infty)$ .

Ko'rsatma:  $\sin(\sin x) < \sin 1 < \sin \frac{\pi}{3} = \frac{\sqrt{3}}{2}$ . **2.33.**  $(-\infty; +\infty)$ . Ko'rsatma:

$[\sin x + \cos x] \leq 1 \leq 2^{|\cos x|}$ . **2.34.**  $(-\infty; +\infty)$ . Ko'rsatma:  $\frac{4}{3}\sin^2\{5x\} \leq \frac{4}{3}\sin^2 1 \leq$

$\leq \frac{4}{3}\sin^2 \frac{\pi}{3} = 1$ . **2.35.**  $(-\infty; +\infty)$ . Ko'rsatma:  $\sin(\{x\} + 1) - \sin\{x\} = 2\sin \frac{1}{2}\cos(\{x\} + \frac{1}{2}) >$

$> 2\cos\left(1 + \frac{1}{2}\right)\sin \frac{1}{2} > 2\cos \frac{\pi}{2}\sin \frac{1}{2} = 0$ . **2.36.**  $[1; +\infty)$ . Ko'rsatma:  $y = \sqrt{x-1} + 2^x + \log_2 x$ ,

$\uparrow$ . **2.37.**  $(1; 2)$ . **2.38.**  $(-\infty; 1]$ . Ko'rsatma:  $y = \sqrt{1-x} + 3 - x - 2^x$  funksiya  $D(y)$

$= (-\infty; 1]$  da  $\downarrow$  va  $y(1) = 0$ . **2.39.**  $\left[k + \frac{1}{2}; k + 1\right)$ ,  $k \in Z$ . **2.40.**  $1 - \frac{\sqrt{2}}{2} < x < 1$ . **2.41.**

$x = \log_3 2 - 4$ ;  $y = 1$ . **2.42.**  $x = y = 2$ ,  $z = -2$ . Ko'rsatma: Tenglamalar

sistemasini  $\begin{cases} x + z = 2 - y, \\ 2yx - z^2 = 4 \end{cases}$  ko'rinishda yozib, bu sistemani  $y$  parametrli sifatida

qarang yoki berilgan sistemaning birinchi tenglamasini kvadratga ko'tarishdan hosil bo'lgan tenglamadan sistemaning ikkinchi tenglamasini

- ayiring. **2.43.**  $x = y = 4$ ,  $z = -4$ . **2.44.**  $x = 3$ ,  $y = 1$ ,  $z = 0$ . **2.45.**  $x = y = z = 1$ .  
**2.46.**  $(1,5; 0,5)$ . **2.47.**  $\left(\frac{1}{4}; \frac{1}{3}\right)$ . **2.48.**  $x = \pm \frac{\pi}{8}$ ;  $y = \mu \frac{\pi}{8}$ . **2.49.**  $(2; 9)$  va  $(-2; -9)$ .  
**2.50.**  $\left(2; \frac{17}{2}\right)$  va  $\left(-2; -\frac{17}{2}\right)$ .

### III b o b

- 3.1.** 1) 3; 17; 55. 2)  $\sqrt{2}$ ;  $\sqrt{5}$ ;  $\sqrt{10}$ ;  $\sqrt{17}$ . **3.5.**  $\frac{\sqrt{5}}{5} \left( \left( \frac{1+\sqrt{5}}{2} \right)^n - \left( \frac{1-\sqrt{5}}{2} \right)^n \right)$ . **3.8.** 1) chegaralanmagan; 2), 3), 4) chegaralangan bo'lishi ham, chegaralanmagan bo'lishi ham mumkin. **3.9.** 1) Yo'q (Masalan  $x_n = -n$ ;  $y_n = 1$  ketma-ketliklarni qarang); 2) Ha. **3.13.** Ko'rsatma:  $a_{n-1} - a_n = \frac{ad-bc}{(cn+d)^2 + c(cn+d)}$  ekanidan foydalaning. 1)  $ad > bc$ ; 2)  $ad < bc$ . **3.21.** 1) Yo'q; 2) Yo'q; 3) Ha; 4) Ha. **3.23.** 1) Ko'rsatma.  $x_n = \frac{1}{18 + \frac{15}{n} + \frac{6}{n^2}}$  ketma-ketlikning chegaralanganligidan foydalaning. **3.24.**  $\frac{1}{2} + \frac{5}{2(4n-3)}$ . **3.27.** 1)  $x_n = 2 + \frac{5}{n+2}$ ;  $\lim_{n \rightarrow \infty} x_n = 2$ ;  
 2)  $x_n = 0 + \left(\frac{1}{n} - \frac{1}{n^2}\right)$ ;  $\lim_{n \rightarrow \infty} x_n = 0$ . **3.28.** 1) 2; 2) 0; 3) 3; 4) 0. **3.30.** 1) 2; 2) 0;  
 3)  $+\infty$ ; 4)  $+\infty$ ; 5) 0; 6) 0; 7) 0; 8) 1. **3.31.** 1)  $\frac{1-b}{1-a}$ ; 2)  $\frac{1}{2}$ ; 3) 5; 4) 1. **3.34.** 1) 1.

### IV b o b

- 4.3.** 1)  $\lim_{x \rightarrow 4-0} f(x) = 8$ ,  $\lim_{x \rightarrow 4+0} f(x) = 2$ ; 2)  $\lim_{x \rightarrow \frac{\pi}{2}-0} f(x) = 1$ ,  $\lim_{x \rightarrow \frac{\pi}{2}+0} f(x) = 0$ . **4.5.** 1) 3; 2) 4; 3) 10; 4) 724; 5) 6; 6) 1. **4.6.** 1) 15; 3) 4; 5)  $\frac{1}{4}$ . **4.7.** 1) Ha; 2) Ha;  
 3) Yo'q; 4) Ha; 5) Yo'q; 6) Ha; 7) Ha; 8) Ha; 9) Yo'q; 10) Yo'q; 11) Ha; 12) Ha.  
**4.8.** 1) 8; 2) 1; 3) 1; 4)  $\infty$ ; 5) 0; 6) 0; 7) 72; 8)  $\infty$ ; 9) 2; 10) 0; 11) 2; 12) 1. **4.9.**  $y = 1$ . **4.10.**  $x = -\sqrt[3]{6}$ . **4.11.**  $y = x$ . **4.12.** 1)  $x = 2$ ,  $y = 0$ ; 2)  $y = x$ ; 3)  $y = -x$ ,  $y = x$ ;  
 4)  $y = -1$ ,  $y = 1$ ; 5)  $x = -1$ ,  $x = 1$ ,  $y = -x$ ; 6)  $y = 0$ ; 7)  $y = -\frac{\pi}{2}x - 1$ ,  $y = \frac{\pi}{2}x - 1$ ;  
 8)  $y = 2x + 1$ ; 9)  $y = 0$ ; 10)  $y = \frac{\pi}{2}$ . **4.13.** 1) uzluksiz; 2) uzluksiz emas; 3) uzluksiz emas; 4) uzluksiz emas; 5) uzluksiz emas; 6) uzluksiz emas. **4.16.** 1)  $x = 0$ ;  
 2)  $x = \frac{\pi}{2} + \pi k$ ,  $k \in \mathbb{Z}$ ; 3)  $x = \pm 1$ ; 4)  $x = \pm 1$ ; 5)  $x = n$ ,  $n \in \mathbb{Z}$ . 6)  $\frac{\pi n}{2}$ ,  $n \in \mathbb{Z}$ .  
**4.17.** 1) Masalan,  $y = \frac{1}{x(x-1)(x-2)}$ ; 3) Masalan,  $y = \frac{1}{\sin x}$ . **4.20.** 1)  $A = 1$ ; 2)  
 $A = \frac{1}{3}$ ; 3)  $A = -6$ ; 4)  $A = 2$ . **4.23.**  $x = 1$ . **4.28.** 1) 1; 2) 1,5; 3)  $\frac{4}{3}$ ; 4)  $\frac{5}{6}$ ; 5)  $\frac{8}{7}$ ;

- 6)  $\frac{1}{3}$ . **4.29.** 1)  $\frac{2}{3}$ ; 2) 2; 3)  $\frac{3}{4}$ ; 4) 15; 5) 1; 6)  $\frac{2}{9}$ ; 7)  $\frac{1}{5}$ ; 8)  $\frac{3}{5}$ ; 9)  $\sqrt{2}$ ; 10) 5;  
 11) 1; 12)  $\frac{1}{6}$ ; 13) 3; 16) 12; 17)  $\frac{2}{\pi}$ ; 18) 1. **4.30.** 1)  $e^1$ ; 2)  $e^{50}$ ; 3) 4; 4)  $\frac{9}{7}$ .

### V b o b

**5.2.** Ko'rsatma: qirraning  $x$  uzunligi va  $\Delta x$  orttirmaga muvofiq hajmning  $\Delta V$  o'zgarishi jadvalda ko'rsatilgan.

$\Delta x$	1	0,5	0,2
$x$	7	2,375	0,728
1	7	2,375	0,728
5	91	41,375	15,608
10	331	157,625	61,218

**5.11.**  $f'(x) = 3x^2 - \frac{6}{5}x + 10$ ,  $f'(0) = 10$ ,

$f(-1) = 14,2$ ,  $f'(1) = 11,8$ . **5.13.** Ko'rsatma:

$$\Delta x = h, \quad \frac{\Delta y}{h} = \frac{\sqrt[3]{x+h} - \sqrt[3]{x}}{h} = \frac{(\sqrt[3]{x+h} - \sqrt[3]{x})(\sqrt[3]{(x+h)^2} + \sqrt[3]{(x+h)x} + \sqrt[3]{x^2})}{h(\sqrt[3]{(x+h)^2} + \sqrt[3]{(x+h)x} + \sqrt[3]{x^2})} = \frac{1}{\sqrt[3]{(x+h)^2} + \sqrt[3]{(x+h)x} + \sqrt[3]{x^2}}$$

Javob:  $y' = \frac{1}{3\sqrt[3]{x^2}}$ . **5.16.** Ko'rsatma:  $h'(t) = v(t) = v_0 - gt$ ,  $\frac{v_0}{2} = v_0 - gt$ , bundan

$t$  aniqlanib,  $h(t)$  ifodaga qo'yiladi. Javob: 5,234375  $\approx$  5,234 m. **5.22.** Ko'rsatma:

$x^2 - 4x + 1 = -2$  bo'yicha  $x_0 = 1$  va  $x_0 = 3$  aniqlanadi. (1; -2) va (3; -2) nuqtalarda berilgan egri chiziqqa urinuvchi to'g'ri chiziqlar  $y = -2x$  va  $y = 2x - 8$ . **5.31.**

$y = 6x - 4$ ,  $d = \frac{\sqrt{37}}{3}$ . **5.32.**  $y = 12x - 28$ . **5.33.** Ko'rsatma:  $x^3 - 1\frac{3}{4}x - 1\frac{1}{4} = -2 \Rightarrow$

$\Rightarrow x^3 - 1 - 1\frac{3}{4}x + 1\frac{3}{4} = 0$ . Endi ko'paytuvchilarga ajrating. Javob:  $y = 1,25x - 3,25$ .

$y = 5x + 5,5$ ,  $y = -x - 1,5$ . **5.41.**  $v(t) = x'(t) = 10 - 0,6t$ ,  $v(6) = 10 - 3,6 = 6,4$  (m/s);

$10 - 0,6t = 0$ , bundan  $t = 16\frac{2}{3}$  (s). **5.44.**  $(uvw)' = u'vw + uv'w + uvw'$ . **5.45.**

Ko'rsatma:  $k = \operatorname{tg}45^\circ = 1$ ,  $y' = (\sqrt[3]{x} - 1)' = (x^{\frac{1}{3}} - 1)' = \frac{1}{3}x^{-\frac{2}{3}} = k = 1$ , bundan

$x = \pm 3\sqrt{3}$ . Endi  $y = \sqrt[3]{x} - 1$  munosabatdan foydalaning. **5.47.** Ko'rsatma:

$f(a+h) \approx f(a) + f'(a)h$  dan foydalaning. Chetlanish  $\alpha h$  ga teng, bunda

$a = \frac{\Delta f}{h} - f'(a)$ . **5.51.** 1)  $-4\cos^3 x \sin x$ ; 2)  $\frac{\operatorname{tg}x}{\cos x}$ ; 3)  $-\frac{4\operatorname{tg}2x}{\sin 2x}$ ; 7)  $(x^3 + 6x + 5)\cos x$ .

**5.55.** 2)  $5\cos(5x + \frac{\pi}{3})$ ; 3)  $42x\sin^2(7x^2 - \frac{\pi}{6})\cos(7x^2 - \frac{\pi}{6})$ ; 10)  $-\frac{\cos \frac{1}{x}}{x^2}$ ; 11)

$\cos(\sin x)\cos x$ ; 12)  $\frac{1}{4\sqrt{\operatorname{tg} \frac{x}{2} \cos^2 \frac{x}{2}}}$ ; 13)  $\frac{x \cos \sqrt{1+x^2}}{\sqrt{1+x^2}}$ ; 14)  $\frac{x^2 - 1}{2x^2 \cos^2(x + \frac{1}{x})\sqrt{1 + \operatorname{tg}(x + \frac{1}{x})}}$ ;

15)  $\frac{\sin(2\frac{1-\sqrt{x}}{1+\sqrt{x}})}{\sqrt{x}(1+\sqrt{x})}$ . **5.59.**  $\frac{\sqrt{5}}{2}$ . **5.60.** 8)  $\frac{\pi}{2(\arccos x)\sqrt{1-x^2}}$ ; 9)  $\arcsin x$ ; 10)

$\sin x \cdot \operatorname{arctg}x + x \cdot \cos x \cdot \operatorname{arctg}x + \frac{x \sin x}{1+x^2}$ ; 11)  $\frac{\operatorname{arctg}x}{2\sqrt{x}} + \frac{\sqrt{x}}{1+x^2}$ ; 12)  $-\frac{2}{|x|\sqrt{x^2-4}}$ ;

13)  $-\frac{1}{(1+x)\sqrt{2x(1-x)}}$ . **5.63.** 1) Ko'rsatma:  $\left(\frac{1}{x^2+9x+20}\right)^{48} = \left(\frac{1}{x+4} - \frac{1}{x+5}\right)^{48} =$   
 $= (3-b, (1))$  munosabat bo'yicha  $\left(\frac{-1}{(x+4)^2} + \frac{1}{(x+5)^2}\right)^{47} = \dots$  **5.65.**  $s' = v = \frac{2\pi A}{T} \cos \frac{2\pi t}{T}$ ,

$s'' = v' = -\frac{4\pi^2 A}{T^2} \sin \frac{2\pi t}{T}$  yoki  $s'' = -\frac{4\pi^2}{T^2} s$ . **5.66.** 1)  $2^x \ln 2$ ; 2)  $4^{-x}(1-x \ln 4)$ ;

3)  $10^x(1+x \ln 10)$ ; 4)  $e^x(\cos x - \sin x)$ ; 5)  $-\frac{\sin x + \cos x}{e^x}$ ; 6)  $-\frac{2 \cdot 10^x \ln 10}{(1+10^x)^2}$ ;

7)  $\frac{e^x(x-1)^2}{(x^2+1)^2}$ ; 8)  $2^x \ln 2 \cdot \cos(2^x)$ . **5.67.** 1)  $2x \log_3 x + \frac{x}{\ln 3}$ ; 2)  $\frac{2 \ln x}{x}$ ; 3)  $\frac{\ln x + 1}{\ln 10}$ ;

4)  $\frac{x \ln x - x + 1}{x \ln^2 x} \ln 2$ ; 5)  $\sin x \ln x + x \cos x \ln x + \sin x$ ; 6)  $-\frac{1}{x \ln^2 x}$ ; 7)  $-\frac{2}{x(1+\ln x)^2}$ ;

8) ctgx. **5.68.** 1)  $\frac{(x+2)(x+4)}{(x+3)^2}$ ; 2)  $\frac{(3-x)x^2}{(1-x)^2}$ ; 3)  $\frac{1-\sqrt{2}}{2\sqrt{x}(1+\sqrt{2x})^2}$ ; 4)  $-\frac{4}{3\sqrt[3]{4x^2}(1+\sqrt[3]{2x})}$ ;

5)  $-\frac{x}{\sqrt{1-x^2}}$ ; 6)  $\frac{mx^{m-1}}{(1-x)^{m+1}}$ ; 7)  $-\frac{2x}{3\sqrt[3]{(1+x^2)^4}}$ ; 8)  $\frac{3-x}{2\sqrt{(1-x)^2}}$ . **5.69.** 1) Ko'rsatma:

$y' = (x^3 + x^2 + 6) = 3x^2 + 2x = 0$ , buning ildizlari  $x_0 = 0, -\frac{2}{3}$ . U holda:

$x < 0$	$x = 0$	$x > 0$
$y' < 0$	$y' = 0$	$y' > 0$

$x < -\frac{2}{3}$	$x = -\frac{2}{3}$	$x > -\frac{2}{3}$
$y' > 0$	$y' = 0$	$y' < 0$

$y_{\min} = 0^3 + 0^2 + 6 = 6$ ;  $y_{\max} = \left(-\frac{2}{3}\right)^3 + \left(-\frac{2}{3}\right)^2 + 6 = 6\frac{4}{27}$ ; 9)  $x_0 = -\frac{b}{2a}$ ,  $a > 0$  da

eng kichik qiymat  $\frac{4ac-b^2}{4a}$ ,  $a < 0$  da eng katta qiymat  $\frac{4ac-b^2}{4a}$ . **5.70.** 2) eng katta

qiymati  $f(3) = 1$ , eng kichik qiymati  $f(-3) = -971,4$ . **5.73.**  $x = \frac{P}{2}$ ,  $y = \frac{P}{2}$ ,

$S_{\max} = \frac{P^2}{8}$ . **5.74.** 2; 2;  $2\sqrt{2}$ . **5.75.**  $x = \frac{2}{3}$ . **5.76.**  $x = r$  da ( $r > 0$ ). **5.78.**

$f^2(x) = 14 + 2\sqrt{(x-2)(16-x)}$  funksiya  $x$  ning qanday qiymatida eng katta qiymatga ega bo'lishini aniqlaymiz.  $x-2$  va  $16-x$  ko'paytuvchilar musbat, ularning yig'indisi 14 ga teng, ya'ni doimiy son. Demak,  $f^2(x)$  funksiya,  $f(x)$  funksiya ham eng katta qiymatni  $x$  ning  $x-2 = 16-x$  tenglikni qanoatlantiradigan qiymatida qabul qiladi. Bu  $x=9$ , unda  $f^2(x) = 28$ . Izlanayotgan eng katta qiymat  $f(9) = \sqrt{28}$ . **5.80.** Ko'rsatma:  $x \leq 1$ ,  $1 < x \leq 2$ ,  $2 \leq x \leq 3$ ,  $3 \leq x < 4$ ,  $x \geq 4$  hollarini qarang. Javob:  $2 \leq x \leq 3$  bo'lishi sharti bilan  $f = 4$ . **5.81.** Ko'rsatma: uchburchakning asosi va balandligi o'zgarmas ekanligidan foydalaning va

$AB = a$ ,  $CD = h$  deb qabul qiling. Eng katta qiymat  $KL$  chiziq o'rtta chiziq bo'lganda hosil bo'ladi. **5.85.** 1)  $\Delta f = f(2) - f(1) = 9$ ;  $\Delta x = 2 - 1 = 1$ ; (1) formula bo'yicha  $f'(c) = \frac{9}{1} = 9$ . Lekin  $f' = 3x^2 + 2$ , bundan  $x = c$  da  $3c^2 + 2 = 9$ ,

$c = \pm\sqrt{\frac{7}{3}}$ , nihoyat,  $c \in [1; 2]$  bo'lganidan  $c = \sqrt{\frac{7}{3}}$ ; 3) quyi tomon yo'nalgan; 4)  $(0; +\infty)$  da qavariqligi bilan yuqoriga,  $(-\infty; 0)$  da quyiga yo'nalgan. **5.88.** 1)  $(-\infty; +\infty)$  da o'sadi; 2)  $(-\infty; +\infty)$  da o'sadi; 3)  $(-\infty; 2)$  da o'sadi,  $(2; 3)$  da kamayadi,  $(3; +\infty)$  da o'sadi. **5.103.** 2)  $-1,66; 0,25; 2; 1$ .

## VI bob

**6.7.** 2) Ko'rsatma:  $2x = t$ ;  $\frac{e^{2x}}{2} + C$ . **6.13.** 1)  $\frac{1}{4}\sin 2x - \frac{1}{2}x \cos 2x + C$ ; 2)  $x \sin x + \cos x + C$ ; 3)  $\frac{-(x+1)}{e^x} + C$ ; 4)  $\frac{3^x}{\ln 3}(x \ln 3 - 1) + C$ ; 5)  $x \ln x - x + C$ ; 6)  $\frac{x^2}{2} \ln x - \frac{x^4}{4} + C$ ; 7)  $\frac{e^x}{2}(\sin x + \cos x) + C$ ; 8)  $e^x(x^2 - 2x + 2) + C$ ; 9)  $x \ln^2 x - 2x \ln x + 2x + C$ . **6.16.** 7)  $8\frac{2}{3}$ ; 8)  $-3$ ; 9)  $\frac{2-\sqrt{3}}{4}$ ; 10)  $11,25$ . **6.18.** 2)  $\frac{\pi}{3}$ ; 4)  $\frac{\pi}{4}$ ; 5)  $17\frac{1}{3}$ . **6.19.** 2)  $1\frac{1}{3}$ ; 4)  $2\frac{2}{3}$ ; 6)  $\frac{8}{9}$ . **6.22.**  $A = 3, B = 0$ . **6.30.**  $64,8$ .

## VII bob

**7.4.**  $s = \frac{gt^2}{2} + v_0 t + s_0$ , bu yerda  $v_0 = v(t_0)$ ,  $s(0) = s_0$ . Ko'rsatma.  $F = ma$ ,  $P = mg$  va  $F = P$  munosabatlardan foydalaning. **7.6.**  $y = e^{x^2}$ . Ko'rsatma.  $y' = 2xy$  va  $y(0) = 1$  dan foydalaning. **7.15.** 1)  $y = \frac{1}{3x}(x^3 - C)$ ; 2)  $y = x^2 + Cx^3$ ; 3)  $y = \sin x + C \cdot \operatorname{tg} \frac{x}{2}$ . **7.16.**  $y = \frac{x}{\cos x} + 1$ . **7.17.**  $y(0) = 1$  shartni qanoatlantiradigan yechim mavjud emas.

## VIII bob

**8.3.**  $3 \cdot 4 = 12$ . **8.4.**  $8; 6$ . **8.5.**  $24$ . **8.10.**  $A_7^3 \cdot A_3^3 = 7 \cdot 6 \cdot 5 \cdot 3 \cdot 2 \cdot 1 = 1260$ . **8.18.**  $C_{20}^4 = 4845$ . **8.19.**  $C_5^2 = 10$ . **8.20.**  $C_{10}^3 \cdot C_{12}^3 = 26400$ . **8.21.**  $C_{49}^5$ . **8.28.** 1)  $k = k_1 + k_2 + k_3 = 4$ ,  $k_i = 0, 1, 2, 3$  ( $k_1, k_2, k_3$ ) kortejlarni tuzamiz:  $(4, 0, 0)$ ,  $(0, 4, 0)$ ,  $(0, 0, 4)$ ,  $(3, 1, 0)$ ,  $(3, 0, 1)$ ,  $(1, 3, 0)$ ,  $(1, 0, 3)$ ,  $(0, 3, 1)$ ,  $(0, 1, 3)$ ,  $(2, 2, 0)$ ,  $(2, 0, 2)$ ,  $(0, 2, 2)$ ,  $(1, 1, 2)$ ,  $(1, 2, 1)$ ,  $(2, 1, 1)$ . Yoyilmada jami 15 ta had bor. Hadlardan ixtiyoriy birini, masalan,  $(2, 1, 1)$  kortejga mosini topamiz. Uning koeffitsiyenti:  $P(2, 1, 1) = \frac{(k!)}{(k_1! \cdot k_2! \cdot k_3!)} = \frac{(4!)}{(2! \cdot 1! \cdot 1!)} = 12$ . Izlanayotgan had  $12a^2bc$  ko'rinishda bo'ladi. **8.31.**  $\overline{C_8^8} = \frac{(12!)}{(8! \cdot 4!)} = \frac{(9 \cdot 10 \cdot 11 \cdot 12)}{(1 \cdot 2 \cdot 3 \cdot 4)} = 495$  va sh.o'. **8.32.** 3)  $C_9^4 \cdot 10!$ .



**8.37.**  $C_4^2 \cdot C_5^3 \cdot 5! = 7200$ . **8.38.**  $C_5^3 \cdot C_6^4 \cdot C_4^3$ . **8.39.**  $9 \cdot 9!$ . **8.40.**  $C_6^3 \cdot C_9^3 \cdot 6!$ . **8.46.**  $P_5 = 5! = 120$ . **8.47.**  $P(2, 2, 1, 1, 1) = (7!)/(2! \cdot 2! \cdot 1! \cdot 1! \cdot 1!) = 1260$ . **8.48.**  $9^4$ . **8.49.**  $C_{21}^4 \cdot C_{17}^4 \cdot C_{13}^4 \cdot C_9^5$ . **8.53.**  $84$ . **8.55.**  $A_{33}^4 = 982080$ .

## IX b o b

**9.8.**  $\{A_0, A_1, A_2, A_3, A_4, A_5, A_6, A_7, A_8, A_9, A_{10}\}$ , bunda  $A_i$  – gerb  $i$  marta tushdi. **9.19.** 1)  $A \cup B = \emptyset$ ; 3)  $A \cap B = \emptyset$  yoki  $A = \emptyset$ ; 4)  $A \subset B$ . **9.20.** Yo‘q. **9.24.** 2)

$K$ ; 7)  $M$ . **9.31.**  $0,77$ . **9.39.**  $A = (A \cap B) \cup (A \cap \bar{B})$ , bunda  $A \cap B$  va  $A \cap \bar{B}$  bog‘liq emas.  $P(A) = P(A \cap B) + P(A \cap \bar{B})$  va shart bo‘yicha  $P(A \cap B) = P(A) \cdot P(B)$  bo‘lganidan  $P(A \cap \bar{B}) = P(A) - P(A \cap B) = P(A) - P(A) \cdot P(B) = P(A) \cdot (1 - P(B)) = P(A) \cdot P(B)$ . **9.41.** Ko‘rsatma:  $P(A \cap \overline{B \cup C}) + P(B \cap \overline{A \cup C}) + P(C \cap \overline{A \cup B})$  ni hisoblang; 4)  $P(A_1 \cap A_2 \cap A_3) = P(A_1) \cdot P(A_2) \cdot P(A_3) = 0,7 \cdot 0,6 \cdot 0,6 = 0,252$ . **9.43.**  $P(A \cap B \cap C) = P(A) \cdot P(B) \cdot P(C) = 0,9 \cdot 0,8 \cdot 0,7 = 0,504$ . **9.45.**  $A_1$  – «birinchi bo‘lakni ikkinchi bo‘lak bilan birlashtirish»ga qolgan  $2n - 1$  ta bo‘lakdan bittasi imkon beradi, demak,  $P(A_1) = 1/(2n - 1)$ ;  $A_k$  – « $k$ - bo‘lakning qolgan  $2n - (2k - 1)$  tasining bittasi bilan ulanish ehtimolligi  $P(A_k) = 1/(2n - (2k - 1))$ . O‘zaro bog‘liq hodisalar ehtimolliklarini ko‘paytirish formulasi bo‘yicha izlanayotgan ehtimollik:  $P = \frac{1}{2n-1} \cdot \frac{1}{2n-3} \cdot \dots \cdot \frac{1}{3} \cdot \frac{1}{1} = \frac{1}{99 \cdot 97 \cdot \dots \cdot 3 \cdot 1}$ .

**9.49.**  $P = 0,4 \cdot 0,4 \cdot 0,4 \cdot 0,6 = 0,0384$ . **9.70.** Ko‘rsatma:  $n = 60$ ,  $x_{\max} = 7$ ,  $x_{\min} = 1$ ,  $\lambda = \frac{7-1}{60} = 0,1$ . **9.71.**  $\bar{\beta} = 65^{\circ}36'03''$ ,  $\sigma(\bar{\beta}) = 1''$ . **9.83.** 2)  $(C_{20}^1 + C_{10}^1)/C_{20}^2 = 48/95$ .

**9.85.**  $A$  – «uch otishda kamida biri nishonga tegdi» ehtimolligi  $P(A) = 1 - q^3 = 0,8$ , bundan  $q = \sqrt[3]{0,2} \cong 0,5848$ . **9.86.**  $P = 1 - 0,2 \cdot 0,3 \cdot 0,4 \cdot 0,5 = 0,88$ . **9.87.**

$n = 5$ ,  $m \geq 2$ ,  $p = 0,6$ ,  $q = 0,4$ .  $P_5(m \geq 2) = 1 - P_5(m < 2) = 1 - \sum_{m=0}^{2-1} P_5(m) = 1 - P_5(0) - P_5(1) = 1 - C_5^0 p^0 q^5 - C_5^1 p^1 q^4 = 0,912$ .

## X b o b

**10.1.**  $\begin{pmatrix} a_{11} & a_{12} & a_{13} & a_{14} & a_{15} \\ a_{21} & a_{22} & a_{23} & a_{24} & a_{25} \\ a_{31} & a_{32} & a_{33} & a_{34} & a_{35} \end{pmatrix}$ . **10.2.**  $A = (1 \ 1 \ 1 \ 1)$ ,  $B = \begin{pmatrix} 0 \\ 0 \\ 0 \\ 0 \end{pmatrix}$ . **10.3.**

$C = \begin{pmatrix} 3 & 3 & 3 & 3 & 3 \\ 4 & 4 & 4 & 4 & 4 \end{pmatrix}$ . **10.4.** 1)  $(3 \ 5 \ 5 \ 9)$ ; 2)  $(1 \ -3 \ 3 \ 6)$ ; 3)  $(44 \ 51 \ 58 \ 65)$ ;

4)  $(-4 \ -3 \ -23 \ -17)$ . **10.5.**  $\begin{pmatrix} 1 & 1 & 1 \\ 1 & 1 & 1 \\ 1 & 1 & 1 \end{pmatrix}$ . **10.7.** 1)  $\begin{pmatrix} -2 & 2 & -1 \\ 2 & 5 & 9 \end{pmatrix}$ ;

$$2) \begin{pmatrix} -4 & 2 & 9 \\ -4 & -3 & 3 \end{pmatrix}; 3) \begin{pmatrix} -10 & 8 & 0 \\ 2 & 12 & 26 \end{pmatrix}; 4) \begin{pmatrix} -3 & 4 & -4 \\ 7 & 14 & 23 \end{pmatrix}. \mathbf{10.9.} \ 1) \begin{pmatrix} \frac{5}{3} & 3 & \frac{13}{3} \\ -\frac{8}{3} & 0 & -\frac{2}{3} \\ -\frac{2}{3} & -\frac{1}{3} & \frac{17}{3} \end{pmatrix}.$$

$$\mathbf{10.28.} \text{ Mavjud emas. } \mathbf{10.29.} \ 4) \begin{pmatrix} 1 & -2 & 7 \\ 0 & 1 & -2 \\ 0 & 0 & 1 \end{pmatrix}; \ 5) \begin{pmatrix} 1 & -3 & 11 & -38 \\ 0 & 1 & -2 & 7 \\ 0 & 0 & 1 & -2 \\ 0 & 0 & 0 & 1 \end{pmatrix};$$

$$6) \begin{pmatrix} \frac{1}{4} & \frac{1}{4} & \frac{1}{4} & \frac{1}{4} \\ \frac{1}{4} & \frac{1}{4} & -\frac{1}{4} & -\frac{1}{4} \\ \frac{1}{4} & -\frac{1}{4} & \frac{1}{4} & -\frac{1}{4} \\ \frac{1}{4} & -\frac{1}{4} & -\frac{1}{4} & \frac{1}{4} \end{pmatrix}. \mathbf{10.30.} \ 1) \begin{pmatrix} 2 & -23 \\ 0 & 8 \end{pmatrix}. \text{ Ko'rsatma: tenglamaning}$$

har ikki qismini ham  $\begin{pmatrix} 2 & 5 \\ 1 & 3 \end{pmatrix}^{-1}$  matritsaga chapdan ko'paytiring; 4) ko'rsatma:

tenglamaning har ikki qismini ham  $\begin{pmatrix} 1 & 2 & -3 \\ 0 & 1 & 2 \\ 0 & 0 & 1 \end{pmatrix}^{-1}$  matritsaga o'ngdan ko'paytiring.

**10.32.** 1)  $x_1 = 2, x_2 = 1, x_3 = 3$ ; 2)  $x = y = z = 0$ ; 3)  $x_1 = 3, x_2 = 1, x_3 = 1$ ;  
 4)  $x = y = z = 0$ . 5)  $x = 3\frac{2}{7}, y = \frac{3}{7}, z = 1\frac{5}{7}$ . 6)  $x_1 = x_2 = x_3 = 0$ . 7)  $x_1 = 3, x_2 = -4,$   
 $x_3 = -1, x_4 = 1$ . 8)  $x_1 = x_2 = x_3 = x_4 = 0$ . 9)  $x_1 = x_2 = x_3 = x_4 = x_5 = 0$ . 10)  $x_1 = 2, x_2 = 0,$   
 $x_3 = -2, x_4 = -2, x_5 = 1$ . **10.41.** 1) (1; 12; 16); 2) (1; 2; 3; 0). **10.42.** 1)  $y = x_1 +$   
 $+ 2x_2 + 3x_3$ . 2)  $0 \cdot x_1 + \frac{1}{3} \cdot x_2 + x_3$ . **10.43.** 1) Yo'q. 2) Ha. **10.44.** 1) Faqat bir xil  
 usulda yoyish mumkin. 2) Faqat bir xil usulda yoyish mumkin. **10.49.** 1)  
 (2; 1; 1). 3) (3; 0; 0). 5) (1; 2; 3).

## ADABIYOT

1. Abduhamidov A., Nasimov H.A. Algebra va matematik analiz asoslari. I qism, «Istiqbol», T., 2000.
2. Abduhamidov A., Nasimov H.A. Algebra va matematik analiz asoslari. II qism. «Istiqbol», T., 2000.
3. Abduhamidov A., Musurmonov O.L., Nasimov H.A. Matematika tarixidan lavhalar. «Matbaa tongi», T., 2000.
4. Alimov Sh.A va b. Algebra va analiz asoslari, 10–11. «O'qituvchi», T., 1996.
5. Башмаков М.И. Алгебра и начала анализа, 10–11. «Просвещение», М., 1999.
6. Болтянский В.Г. и др. Лекции и задачи по элементарной математике. «Наука», Т., 1972.
7. Вересова Е.Е. и др. Практикум по решению математических задач. «Просвещение», М., 1979.
8. Vilenkin N.Ya. va b. Algebra va matematik analiz, 10. «O'qituvchi», T., 1992.
9. Galitskiy M.L. va b. Algebra va matematik analiz kursini chuqur o'rganish. «O'qituvchi», T., 1985.
10. Глейзер Г.Д. и др. Алгебра и начала анализа. «Просвещение», М., 1989.
11. Гнеденко Б.В. и др. Элементарное введение в теорию вероятностей. «Наука», М., 1982.
12. Gnedenko B.V. va b. «Yosh matematik» qomusiy lug'ati. «O'zME», T., 1992.
13. Говоров В.М. и др. Сборник конкурсных задач по математике. «Наука», М., 1983.
14. Guter R.S. va b. Differensial tenglamalar. «O'qituvchi», T., 1979.
15. Карп А.П. Сборник задач по алгебре и началам анализа. «Просвещение», М., 1995.
16. Kolmogorov A.N. va b. Algebra va analiz asoslari, 10–11. «O'qituvchi», T., 1992.
17. Потапов М.К. и др. Алгебра и анализ элементарных функций. «Наука», М., 1981.
18. To'laganov T.R. Elementar matematika. «O'qituvchi», T., 1997.
19. Umirbekov A.U. Shaabzalov Sh.Sh. Matematikani takrorlang. «O'qituvchi», T., 1989.
20. Shneyder V.Ye. va b. Oliy matematika qisqa kursi. I tom. «O'qituvchi», T., 1985.
21. Bittinger L.Marlin, Beecher A.Judith. Development Mathematics. Addison-Wesley. Indiana University, USA, 2000.
22. Nassiet S., Torte D., Rivoallan L. Matematikyes Analyse. Didier, Paris, 1995.
23. Donkemts G. Matematikyes Analyse. Didier, Paris, 1995.

# M U N D A R I J A

So'zboshi ..... 3

## I b o b. TRIGONOMETRIK FUNKSIYALAR

1- §. Sonli argumentning trigonometrik funksiyalari ..... 4

1. Burchaklar va yoylar (4). 2. Burchak va yoylarning radian o'lehoivi. Koordinatali aylana (8). 3. Sonli argumentning sinusi, kosinusi, tangensi va kotangensi (12). 4. Trigonometrik funksiyalarning davriyligi (18). 5. Sinus va kosinus funksiyalarning xossalari (20). 6. Tangens va kotangens funksiyalarning xossalari (25).

2- §. Trigonometrik funksiyalarning grafiklari ..... 29

1. Sinus va kosinus funksiyalarning grafigi (29). 2. Sinusoidal tebranishlar (32). 3. Tangens va kotangens funksiyalarning grafigi (33).

3- §. Qo'shish formulalari ..... 35

1. Ikki burchak ayirmasining va yig'indisining kosinusi va sinusi (35). 2. Ikki burchak yig'indisi va ayirmasining tangensi va kotangensi (37). 3. Keltirish formulalari (39). 4. Ikkilangan va uchlangan argumentning trigonometrik funksiyalari (41). 5. Yarim argumentning trigonometrik funksiyalari (44). 6. Trigonometrik funksiyalarni yarim argument tangensi orqali ifodalash (46). 7. Trigonometrik funksiyalar yig'indisini ko'paytmaga va ko'paytmasini yig'indiga aylantirish (47). 8. Garmonik tebranishlarni qo'shish (51).

4- §. Trigonometrik tenglamalar va tengsizliklar ..... 53

1.  $\sin\alpha = m$  ko'rinishdagi eng sodda tenglama. Arksinus (54). 2.  $\cos\alpha = m$  ko'rinishdagi eng sodda tenglama. Arkkosinus (57). 3.  $\operatorname{tg}\alpha = m$  va  $\operatorname{ctg}\alpha = m$  ko'rinishdagi eng sodda tenglamalar. Arktangens va arkkotangens (61). 4. Tenglamalarni yechishning asosiy usullari (63). 5. Xususiy usullar (66). 6. Universal almashtirish (72). 7. Trigonometrik tenglamalar sistemasi (74). 8. Trigonometrik tengsizliklarni isbotlash (75). 9. Eng sodda trigonometrik tengsizliklarni yechish (77). 10. Trigonometrik tengsizliklarni intervallar usuli bilan yechish (81). 11. Trigonometrik funksiya qiymatini taqribiy hisoblash (83).

5- §. Teskari trigonometrik funksiyalar ..... 84

1. Arkfunksiyalar va ularning asosiy xossalari (84). 2. Arkfunksiyalar qatnashgan ayrim ayniyatlar (89). 3. Teskari trigonometrik funksiyalar qatnashgan tenglamalar va tengsizliklar (91).

## II b o b. NOSTANDART TENGLAMALAR, TENGSIZLIKLAR VA ULARNING SISTEMALARI

1- §. Nostandart tenglamalar ..... 98

2- §. Nostandart tengsizliklar ..... 102

**3- §. Nostandart sistemalar** ..... 107

### **III b o b. SONLI KETMA-KETLIKLER VA ULARNING LIMITI**

**1- §. Cheksiz sonli ketma-ketliklar** ..... 111

**1.** Ketma-ketlik tushunchasi (111). **2.** Chegaralangan ketma-ketliklar (114). **3.** Monoton ketma-ketliklar (117). **4.** Progressiyalar (120).

**2- §. Ketma-ketlikning limiti** ..... 113

**1.** Ketma-ketlikning qirqimi. Cheksiz kichik ketma-ketliklar (126). **2.** Cheksiz kichik ketma-ketliklar haqidagi asosiy teoremlar (128). **3.** Cheksiz katta ketma-ketliklar (131). **4.** Ketma-ketlikning limiti (133). **5.** Limitlar haqida asosiy teoremlar (136). **6.** Monoton ketma-ketlikning limiti haqidagi teorema (140).

### **IV b o b. FUNKSIYANING LIMITI VA UZLUKSIZLIGI**

**1- §. Funksiyaning limiti** ..... 143

**1.** Funksiyaning nuqtadagi bir tomonlama limiti (143). **2.** Funksiyaning nuqtadagi limiti (148). **3.** Funksiyaning nuqtadagi limiti haqidagi asosiy teoremlar (152). **4.** Funksiyaning cheksizlikdagi limiti (156). **5.** Funksiya grafigining asimptotasi (160).

**2- §. Funksiyaning uzluksizligi** ..... 163

**1.** Funksiyaning nuqtada uzluksizligi va uzilishi (163). **2.** Funksiyaning oraliqda uzluksizligi (169). **3.** Ajoyib limitlar (173).

### **V b o b. HOSILA**

**1- §. Funksiyaning hosilasi va differensial** ..... 177

**1.** Funksiya ortirmasi (177) **2.** Funksiya hosilasi (178). **3.** Funksiya differensial (184). **4.** Funksiya grafigiga urinuvchi to'g'ri chiziq (185). **5.** Differensiallanuvchi funksiyaning uzluksizligi (186).

**2- §. Funksiyani differensiallash qoidalari** ..... 188

**1.** Chiziqli kombinatsiyalarni differensiallash (188). **2.** Darajali funksiyaning va funksiyalar ko'paytmasini differensiallash (191). **3.** Kasrni differensiallash (195). **4.** Trigonometrik funksiylarni differensiallash (196). **5.** Murakkab funksiya hosilasi (199). **6.** Teskari trigonometrik funksiylarni differensiallash (201). **7.** Yuqori tartibli hosilalar (205). **8.** Ko'rsatkichli, logarifmik va darajali funksiylarning hosilasi (206).

**3- §. Hosilaning tatbiqi** ..... 209

**1.** Funksiyaning ekstremumlarini aniqlash (209). **2.** Funksiyaning kesmadagi eng katta va eng kichik qiymatlarini topish (213). **3.** Lagranj teoremasi. Funksiyaning o'sishi va kamayishi (218). **4.** Funksiya grafigining qavariqligi (221). **5.** Funksiya grafigining bukilish nuqtalari (223). **6.** Funksiya grafiglarini yasash tartibi (225). **7.** Hosila yordamida tengsizliklarni isbotlash (229).

8. Nyuton binomi (232). 9. Nyuton binomidan taqribiy hisoblashlarda foydalanish (235). 10. Tenglamalarni taqribiy yechish (Vatarlar va urinmalar usullari) (237).

## **VI b o b. INTEGRAL**

### **1- §. Aniqlanmas integral ..... 242**

1. Integrallash amali. Boshlang'ich funksiya (242). 2. Integrallash formulalari (246). 3. O'zgaruvchini almashtirish usuli (249). 4. Bo'laklab integrallash (252).

### **2- §. Aniq integral ..... 253**

1. Egri chizikli trapetsiya yuzi. Boshlang'ich funksiya orttirmasi. Aniq integral (253). 2. Nyuton–Leybnits teoremi (258). 3. Geometrik va fizik kattaliklarni aniq integral yordamida hisoblash (263). 4. Aniq integralning qiymatini taqribiy hisoblash (266).

## **VII b o b. DIFFERENSIAL TENGLAMALAR**

### **1- §. Eng sodda differensial tenglamalar ..... 270**

1. Differensial tenglama haqida tushuncha. Differensial tenglamalarga olib keluvchi masalalar (270). 2. Eng sodda differensial tenglamalarni yechish (273).

### **2- §. Birinchi tartibli oddiy differensial tenglamalar ..... 278**

1. O'zgaruvchilari ajraladigan tenglamalar (278). 2. Birinchi tartibli chizikli differensial tenglamalar (279).

## **VIII b o b. KOMBINATORIKA ELEMENTLARI**

### **1- §. Kombinatorikaning asosiy qoidalari ..... 282**

1. Kombinatorikada nima o'rganiladi? (282). 2. Ko'paytmani topish qoidasi (283).

### **2- §. Kombinatorikaning asosiy formulalari ..... 285**

1. O'rinlashtirishlar (285). 2. Takrorsiz o'rin almashtirishlar (288). 3. Takrorsiz kombinatsiyalar (289). 4. Takrorli o'rin almashtirishlar (291). 5. Takrorli kombinatsiyalar (296).

## **IX b o b. EHTIMOLLIK NAZARIYASI VA MATEMATIK STATISTIKA ELEMENTLARI**

### **1- §. Ehtimollikni hisoblash ..... 300**

1. Ehtimollik nazariyasi nimanı o'rganadi? (300). 2. Boshlang'ich tushunchalar (301). 3. Ehtimollikni bevosita hisoblash (302). 4. Hodisalar algebrasi (306). 5. Hodisalar yig'indisining ehtimolligi (309).

### **2- §. Bog'liqlanmas hodisalar ..... 312**

1. Bog'liqlanmas tasodifiy hodisalar (312). 2. Shartli ehtimollik (315). 3. Bernulli formulasi (320). 4. Geometrik ehtimolliklar (321).

<b>3- §. Matematik statistika elementlari .....</b>	<b>323</b>
<b>1. Boshlang'ich ma'lumotlar (323). 2. Arifmetik o'rtacha qiymat va o'rta kvadratik chetlanish (324). 3. Taqsimot jadvali, gistogramma, poligon (325). 4. Bosh to'plam, tanlanma to'plam (328).</b>	
<b>X b o b. CHIZIQLI ALGEBRA ELEMENTLARI</b>	
<b>1- §. Matritsalar va determinantlar .....</b>	<b>333</b>
<b>1. Matritsalar (333). 2. Kvadrat matritsaning determinanti (343). 3. Teskari matritsa (349). 4. <math>n</math> noma'lumli <math>n</math> ta chiziqli tenglamalar sistemasini matritsalar yordamida yechish (352).</b>	
<b>2- §. Chiziqli fazo .....</b>	<b>354</b>
<b>1. Chiziqli fazo tushunchasi (354). 2. Chiziqli erkli va chiziqli bog'liq vektorlar (359). 3. Chiziqli fazoning o'lchovi va bazisi (365).</b>	
<b>TEST SAVOLLARIDAN NAMUNALAR .....</b>	<b>369</b>
<b>JAVOBLAR .....</b>	<b>381</b>
<b>ADABIYOT .....</b>	<b>394</b>

ABDUHAMIDOV ABDUHAKIM USMONOVICH,  
NASIMOV HUSAN ABDIRAHIMOVICH,  
NOSIROV UMARQUL MISIROVICH,  
HUSANOV JUMANAZAR HUSANOVICH

**ALGEBRA VA MATEMATIK  
ANALIZ ASOSLARI**

**II qism**

*Akademik litseylar uchun darslik*

7- nashri

*«O'qituvchi» nashriyot-matbaa ijodiy uyi  
Toshkent—2008*

Muharrirlar: *O. Husanov, N. G'oirov*  
Rasmlar muharriri *F. Nekqadambayev*  
Tex. muharrir *T. Greshnikova*  
Musahhhah *Z. Sodiqova*  
Kompyuterda sahifalovchi *M. Sagdiyliyeva*

Original-maketdan bosishga ruxsat etildi 10.04.2008. Bichimi 60×90<sup>1/16</sup>.  
Kegli II shponli. Tayms garn. Ofset bosma usulida bosildi. Shartli b. t.  
25,0. Nashr. t. 22,5. 38596 nusxada bosildi. Buyurtma №251.

O'zbekiston Matbuot va axborot agentligining „O'qituvchi“  
nashriyot-matbaa ijodiy uyi. Toshkent—129, Navoiy ko'chasi 30-uy. //  
Toshkent, Yunusobod dahasi, Murodov ko'chasi, 1- uy.  
Shartnoma 09—54—08.



22.14

A 45

**Algebra va matematik analiz asoslari:**

Akad. litseylar uchun darslik / **A.U.Abduhamidov,**

**H.A.Nasimov, U.M.Nosirov, J.H.Husanov**

[**H.A.Nasimovning** umumiy tahriri ostida];

O'zbekiston Respublikasi Oliy va o'rta maxsus ta'lim

vazirligi, O'rta maxsus, kasb-hunar ta'limi markazi. 7-

nashr. – T.: «O'qituvchi» NMIU, 2008. Q.I. – 400 b.

**I. Abduhamidov A.U. va boshq.**

ББК 22.14я722

22.161я722



**«O'QITUVCHI»**

**[www.oqituvchi.uz](http://www.oqituvchi.uz)**  
**224-04-12**

ISBN 978-9943-02-072-6



9 789943 020726